

Sterilisation
Sterilization
Sterilisation
Esterilización
Sterilizzazione

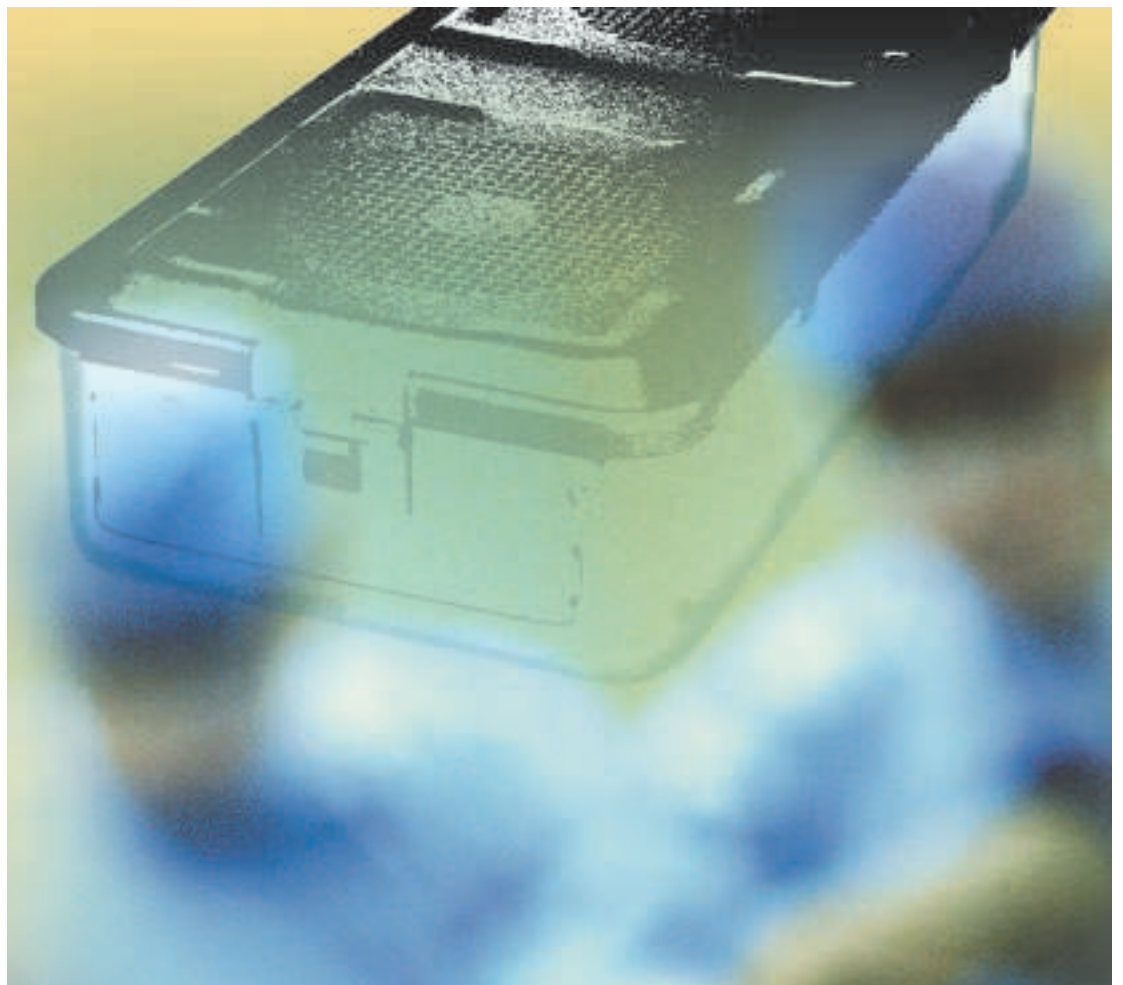

1/2 Container, ALU

Deckel gelocht und farbig
 Lid perforated and colored
 Couvercle perforé et coloré
 Tapas perforadas y coloreados
 Coperchio perforato e colorato

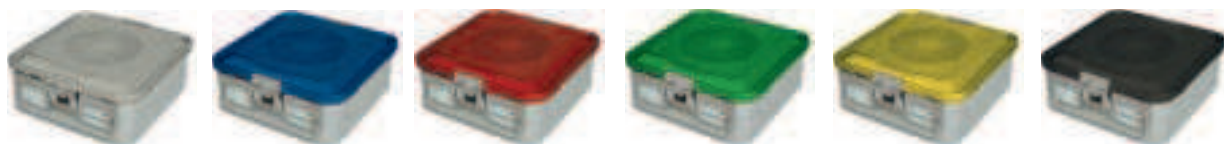

L x B x H mm

285x280x100	80.6001	80.6002	80.6003	80.6004	80.6005	80.6006
285x280x135	80.6011	80.6012	80.6013	80.6014	80.6015	80.6016
285x280x150	80.6021	80.6022	80.6023	80.6024	80.6025	80.6026
285x280x200	80.6031	80.6032	80.6033	80.6034	80.6035	80.6036
285x280x260	80.6041	80.6042	80.6043	80.6044	80.6045	80.6046

Zubehör · Accessories · Accessoires · Accesorios · Accessori

für
1/2 Container

for
1/2 Containers

pour
1/2 Containers

para
1/2 Contenedores

per
1/2 Contenitori



Siebkörbe
Wire baskets
Plateaux inox
Bandejas inoxidable
Cestelli in acciaio fino

80.6203	255x245x 30 mm
80.6205	255x245x 50 mm
80.6207	255x245x 70 mm
80.6210	255x245x100 mm



Spannrahmen
Cloth fixing frames
Cadres fixe-toile
Cuadros para fijar panos
Telai fissateli

80.6231	255x255 mm
---------	------------



80.6232	255x255x30 mm
---------	---------------



Teiler
Deviders
Cloisons
Tabiques
Divisori

80.6240	255x245x130 mm
---------	----------------

3/4 Container, ALU

Deckel gelocht und farbig
 Lid perforated and colored
 Couvercle perforé et coloré
 Tapas perforadas y coloreados
 Coperchio perforato e colorato

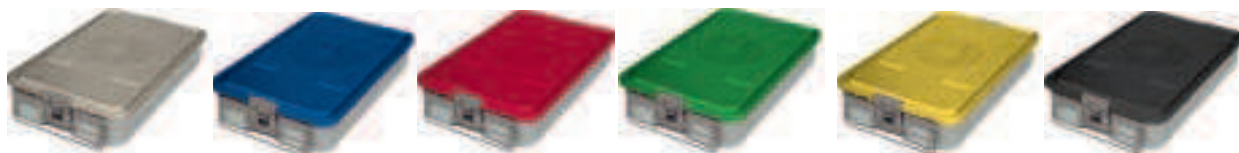

L x B x H mm

465x280x100	80.6301	80.6302	80.6303	80.6304	80.6305	80.6306
465x280x135	80.6311	80.6312	80.6313	80.6314	80.6315	80.6316
465x280x150	80.6321	80.6322	80.6323	80.6324	80.6325	80.6326

Zubehör · Accessories · Accessoires · Accesorios · Accessori

für
3/4 Container

for
3/4 Containers

pour
3/4 Containers

para
3/4 Contenedores

per
3/4 Contenitori



Siebkörbe
Wire baskets
Plateaux inox
Bandejas inoxidable
Cestelli in acciaio fino

80.6503	405x245x 30 mm
80.6505	405x245x 50 mm
80.6507	405x245x 70 mm
80.6510	405x245x100 mm



Spannrahmen
Cloth fixing frames
Cadres fixe-toile
Cuadros para fijar panos
Telai fissateli

80.6531	405x255 mm
---------	------------



80.6532	405x255x30 mm
---------	---------------



Teiler
Deviders
Cloisons
Tabiques
Divisori

80.6540	405x250x130 mm
---------	----------------



80.6541	405x250x130 mm
---------	----------------

1/1 Container, ALU

Deckel gelocht und farbig
 Lid perforated and colored
 Couvercle perforé et coloré
 Tapas perforadas y coloreadas
 Coperchio perforato e colorato

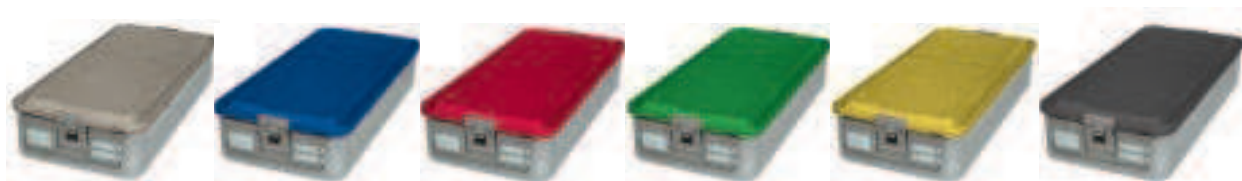

L x B x H mm

580x280x100	80.6601	80.6602	80.6603	80.6604	80.6605	80.6606
580x280x135	80.6611	80.6612	80.6613	80.6614	80.6615	80.6616
580x280x150	80.6621	80.6622	80.6623	80.6624	80.6625	80.6626
580x280x200	80.6631	80.6632	80.6633	80.6634	80.6635	80.6636
580x280x260	80.6641	80.6642	80.6643	80.6644	80.6645	80.6646

Zubehör · Accessories · Accessoires · Accesorios · Accessori

für
1/1 Container

for
1/1 Containers

pour
1/1 Containers

para
1/1 Contenedores

per
1/1 Contenitori



Siebkörbe
Wire baskets
Plateaux inox
Bandejas inoxidable
Cestelli in acciaio fino

80.6803	485x285x 30 mm
80.6805	485x285x 50 mm
80.6807	485x285x 70 mm
80.6810	485x285x100 mm
80.6813	540x285x 30 mm
80.6815	540x285x 50 mm
80.6817	540x285x 70 mm
80.6820	540x285x100 mm



Spannrahmen
Cloth fixing frames
Cadres fixe-toile
Cuadros para fijar panos
Telai fissateli

80.6841	545x245 mm
---------	------------

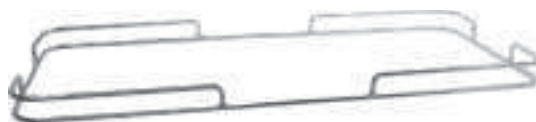

80.6842	545x245x30 mm
---------	---------------



Teiler
Deviders
Cloisons
Tabiques
Divisori

80.6850	510x250x130 mm
---------	----------------



80.6851	510x250x130 mm
---------	----------------

Flach- und Mini-Container, ALU eloxiert

Flat- and Mini-Containers, ALU

Containers plates et mini en aluminium

Contenedores planos y mini de aluminio

Contenitori piatti e mini in alluminio

Deckel gelocht und farbig

Lid perforated and colored

Couvercle perforé et coloré

Tapas perforadas y coloreados

Coperchio perforato e colorato



Flach - Flat - Plat - Plano - Platto

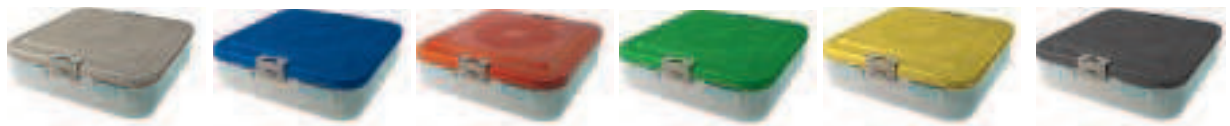

L x B x H mm

285x280x55	80.7001	80.7002	80.7003	80.7004	80.7005	80.7006
285x280x85	80.7011	80.7012	80.7013	80.7014	80.7015	80.7016

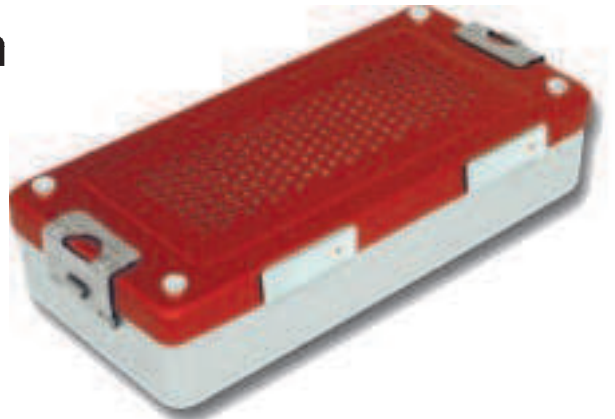

Mini

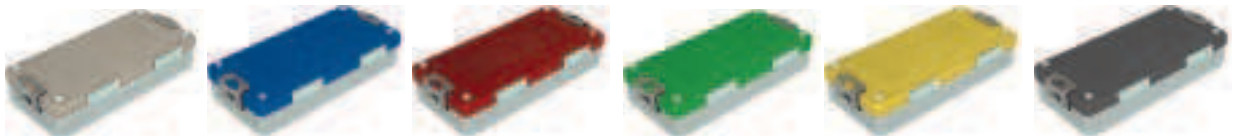

L x B x H mm

300x140x40	80.7301	80.7302	80.7303	80.7304	80.7305	80.7306
300x140x70	80.7311	80.7312	80.7313	80.7314	80.7315	80.7316
300x140x100	80.7321	80.7322	80.7323	80.7324	80.7325	80.7326

Zubehör · Accessories · Accessoires · Accesorios · Accessori

für FLACH- und
MINI-Container

for FLAT- and
MINI-Containers

pour Containers
PLARTS et MINI

para Contenedores
PLANOS y MINI

per Contenitori
PIATTI e MINI



Siebkorb mit Deckel
Wire basket with lid
Panier avec couvercle
Cestillo con cobertera
Cestello con coperchio

80.7410 267x125x50 mm



Siebeinlage f. MINI-Container
Separate base for MINI-Container
Fond du crible pour MINI-Container
Base para MINI-Container
Base per MINI-Container

80.7420 270x125 mm



Spannrahmen für Mini-Container
Cloth fixing frames for MINI-Container
Cadres fixe-toile pour MINI-Container
Cuadros para fijar panos para MINI-Container
Telai fissateli per MINI-Container

80.7431 270x125 mm

Endoskopie-Container, ALU eloxiert

Endoscopy-Containers, ALU

Containers a endoscopie en alumium

Contenedores para endoscopiade aluminio

Contenitori per endoscopia in alluminio

Deckel gelocht und farbig

Lid perforated and colored

Couvercle perforé et coloré

Tapas perforadas y coloreados

Coperchio perforato e colorato



L x B x H mm

250x60x50

80.7501

80.7503

80.7504

450x70x70

80.7511

80.7513

80.7514

Zubehör · Accessories · Accessoires · Accesorios · Accessori

Siebköbe Endoskopie

Wire baskets Endoscopy

Paniers Endoscopie

Cestillos Endoscopia

Cestilli Endoscopia



80.7551 290x 80x50 mm

80.7552 460x 80x50 mm

80.7553 640x150x77 mm

Dental Container, ALU eloxiert

Dental Containers, ALU

Containers pour instrumentation dentaire en aluminium

Contenedores para instrumental dental aluminio

Contentori per strumenti dentali in alluminio

Deckel gelocht und farbig

Lid perforated and colored

Couvercle perforé et coloré

Tapas perforadas y coloreados

Coperchio perforato e colorato

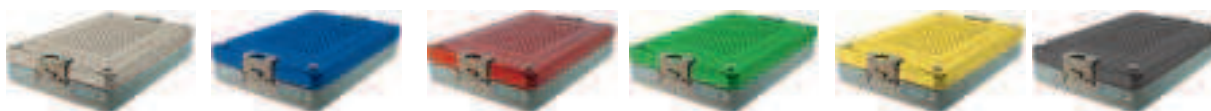

L x B x H mm

310x190x40	80.7601	80.7602	80.7603	80.7604	80.7605	80.7606
310x190x65	80.7611	80.7612	80.7613	80.7614	80.7615	80.7616
310x190x130	80.7621	80.7622	80.7623	80.7624	80.7625	80.7626

Zubehör · Accessories · Accessoires · Accesorios · Accessori

Siebkorb mit Deckel

Wire basket with lid

Panier avec couvercle

Cestillo con cobertera

Cestello con coperchio



80.7801

274x172x43 mm

Spannrahmen für Dental-Container

Cloth fixing frames for dental containers

Cadres fixe-toile pour container dentaire

Cuadros para fijar panos para container dental

Telai fissateli per contenitori dentali



80.7821

274x172 mm

Zubehör · Accessories · Accessoires · Accesorios · Accessori

Kennzeichnungsschilder, Aluminium ohne Text
Identification labels, aluminium, neutral
Plaquettes d'identificationen aluminium, neutres
Placas de identificación, aluminio, neutral
Targhette di identificazione d'alluminio, neutre



80.7901 80.7902 80.7903 80.7904 80.7905 80.7906

Kennzeichnungsschilder, Aluminium graviert
Identification labels, aluminium, engraved
Plaquettes d'identificationen aluminium, gravées
Placas de identificación, aluminio, grabadas
Targhette di identificazione d'alluminio, incise



80.7911 80.7912 80.7913 80.7914 80.7915 80.7916

Sortiermagazin für Kennzeichnungsschilder
Rack for identification labels
Magasin à plaquettes d'identification
Cajita para seleccionar placas
Cassetta da selezione tharghette



80.7950

Indikator-Schilder, Papier, 100 St.
Indicating labels, paper, 100 pcs.
Etiquettes d'identification en papier, les 100
Etiquetas indicadoras, papel 100 c/u
Targhette con indicatore, papel, 100 pezzi

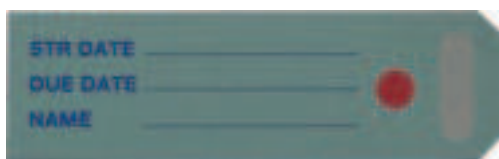

80.7960

klein / small / petite / pequenas / piccolo



80.7962

groß / large / grande / grande / grande

Sicherungsplomben, Plastik, 100 St.
Safety Seals, plastic, 100 pcs.
Scellés de sécurité, plastique, les 100
Precintos de seguridad,plastico 100 c/u
Sigilli di sicurezza, plastica, 100 pezzi



80.7980

Zubehör · Accessories · Accessoires · Accesorios · Accessori

Filterspender für 1/2, 3/4, 1/1 Container-Filter
Filter Dispenser for 1/2, 3/4, 1/1 Container-Filters
Présentoir de filtres pour les 1/2, 3/4, 1/1 Containers
Distribuidor de filtros para los 1/2, 3/4, 1/1 Containers
Distributore di filtri per 1/2, 3/4, 1/1 Container



80.8000

Filterhalter für 1/2, 3/4, 1/1 Container
Filter Holder for 1/2, 3/4, 1/1 Containers
Fixe-filtres pour 1/2, 3/4, 1/1 Containers
Sujetafiltros para los 1/2, 3/4, 1/1 Containers
Fermafilttri per 1/2, 3/4, 1/1 Container



80.8010

Filter, Einmalgebrauch, Papier 1000 St.
Single use filters, paper 1000 pcs.
Filtres en papier à usage unique, les 1000
Filtros, monouso, papel, 1000 c/u
Filtri, monouso, carta, 1000 pezzi

FILTER, Papier für 1/2, 3/4, 1/1 Container
for 1/2, 3/4, 1/1 Containers
pour 1/2, 3/4, 1/1 Containers
para los 1/2, 3/4, 1/1 Containers
per 1/2, 3/4, 1/1 Container

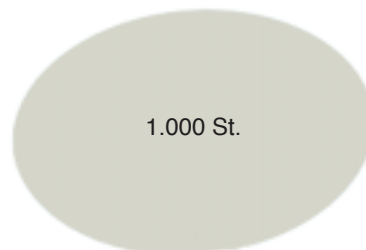

80.8050

FILTER, Papier für MINI-Container
for MINI-Containers
pour MINI-Containers
para MINI-Containers
per MINI-Containers



80.8052

FILTER, Papier für DENTAL Container
for DENTAL-Containers
pour DENTAL-Containers
para DENTAL-Containers
per DENTAL-Containers



80.8054

Zubehör · Accessories · Accessoires · Accesorios · Accessori

Langzeit-Textilfilter, 1 St.
Long-term textile filters, 1 pc.
Filtres en textile, la pièce
Filtros de textil, 1 c/u
Filtri tessili, il pezzo

FILTER, Textil für 1/2, 3/4, 1/1 Container
for 1/2, 3/4, 1/1 Containers
pour 1/2, 3/4, 1/1 Containers
para los 1/2, 3/4, 1/1 Containers
per 1/2, 3/4, 1/1 Container



1 St.

80.8060

FILTER, Textil für MINI-Container
for MINI-Containers
pour MINI-Containers
para MINI-Containers
per MINI-Containers

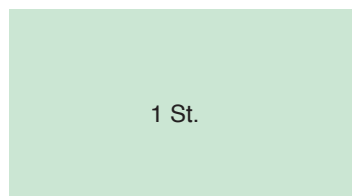

1 St.

80.8062

FILTER, Textil für DENTAL Container
for DENTAL-Containers
pour DENTAL-Containers
para DENTAL-Containers
per DENTAL-Containers



1 St.

80.8064

Sterilisier-Tücher, Baumwolle
Sterilizing Drapes, cotton
Champs à stérilisation, coton
Paños de esterilización de algodón
Pannos di sterilizzazione, cotone

80.8100 40 x 60 cm
80.8105 85 x 85 cm
80.8110 100 x 140 cm
80.8115 275 x 125 cm
80.8120 245 x 245 cm



**80.8100-
80.8120**

Noppenmatten, Silikon
Silicone Pads
Tapis port-instruments, silicone
Tapices porta instrumentos de silicona
Tapetti porta-strumenti in silicone

80.8131 275 x 125 mm
80.8132 225 x 225 mm
80.8133 300 x 300 mm

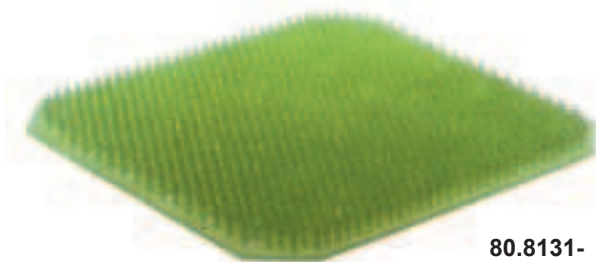

**80.8131-
80.8133**

Zubehör · Accessories · Accessoires · Accesorios · Accessori

Fixierklammern für Tücher
Fixation Clamps for Drapes
Pinces fixe-toiles
Grapas para fijar paños
Pinze di fillaggio per teli



80.8150



80.8160 Ø 7 - 12 mm
80.8161 Ø 12 - 16 mm
80.8162 Ø 16 - 26 mm
80.8163 Ø 26 - 36 mm
80.8164 Ø 36 - 45 mm



80.8160-
70.8164

Fixierfedern
Spiral Supports
Ressorts spiraux
Apoyos con resorte spiral
Supporte a molle

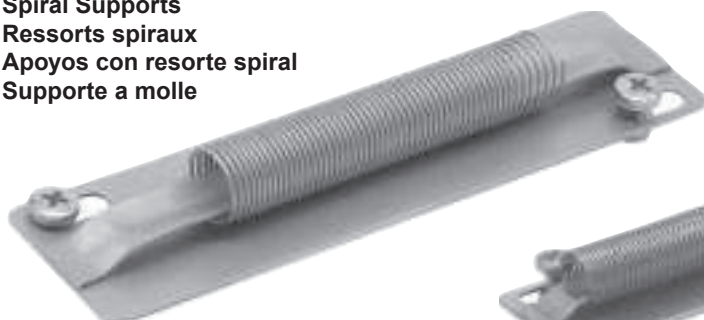

80.8191 115 x 30 mm



80.8192 230 x 30 mm

80.8140 SILIKON Fixierstreifen Set

bestehend aus:

80.8141 1 Silikon Streifen 246 x 13 mm

80.8142 2 Silikon Halteknöpfe

SILICONE Storage Strip Set

consisting of:

80.8141 1 Silicone Storage Strip 246x13 mm

80.8142 2 Silicone Fastening Knobs

SILICONE bande porte instrum. 243 x 13 mm

Jeu comprenant:

80.8141 1 Silicone bande à sécurité 243 x 13 mm

80.8142 2 Silicone boutons à fixation

SILICONE tira de protección 243 x 13 mm

Juego compuesto de:

80.8141 1 Silicone tira de protección 243 x 13 mm

80.8142 2 Silicone botones de fijar

SILICONE strisce per assicurare 243x13 mm

Set composto da:

80.8141 1 Silicone strisce per assicurare 243x13 mm

80.8142 2 Silicone botoni de fissare

80.8141 246x13 mm



80.8142 2 Stück / 2 pieces / 2 pièces / 2 piezas / 2 pezzi

Zubehör · Accessories · Accessoires · Accesorios · Accessori

Haltestifte, Trennbleche
Fixing bolts, Dividers
Attaches de fixation, Séparateurs
Piñons para fijar, Separadores
Perne di fissaggio, Divisori

Haltestift für Instrumente
for instruments
pour instruments
para instrumentos
per strumenti



80.8201

Haltestift für Trennbleche
for Dividers
pour Séparateurs
para Separadores
per Divisori



80.8202

Trennbleche
Dividers
Séparateurs
Separadores
Divisori

80.8211	50x20 mm
80.8212	130x20 mm
80.8213	225x20 mm
80.8214	460x20 mm

Winkelbleche
Angled Dividers
Séparateurs angulés
Separadors angulados
Divisori angulate

80.8221	110 mm
80.8222	170 mm
80.8223	230 mm
80.8223	470 mm

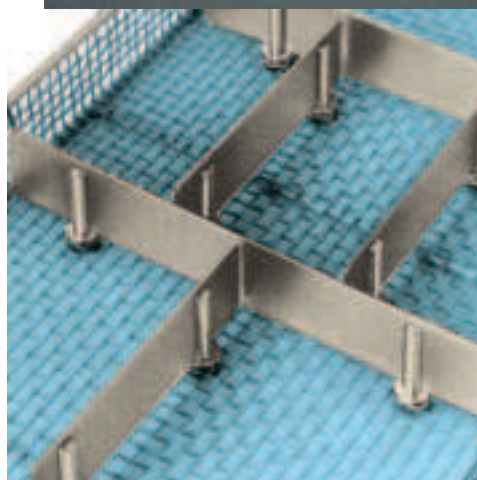
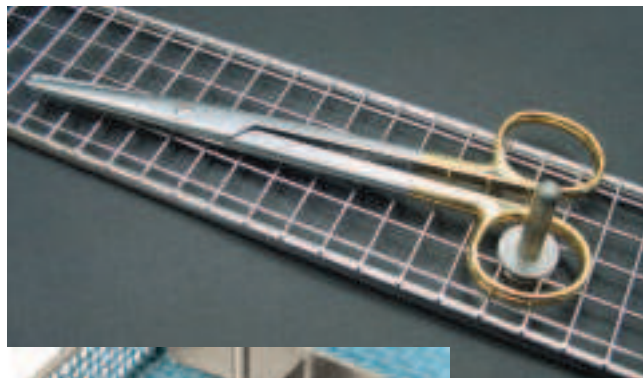

Sterilisierahmen für 8 Mikro-Instrumente
Sterilizing Rack for 8 Micro-Instruments
Chevalet à Sterilisation pour 8 Micro-Instruments
Porta-instrumentos para 8 Micro Instrumentos
Telaio per sterilizzazione per 8 micro-strumenti

80.3190 190 x 36 x 35 mm

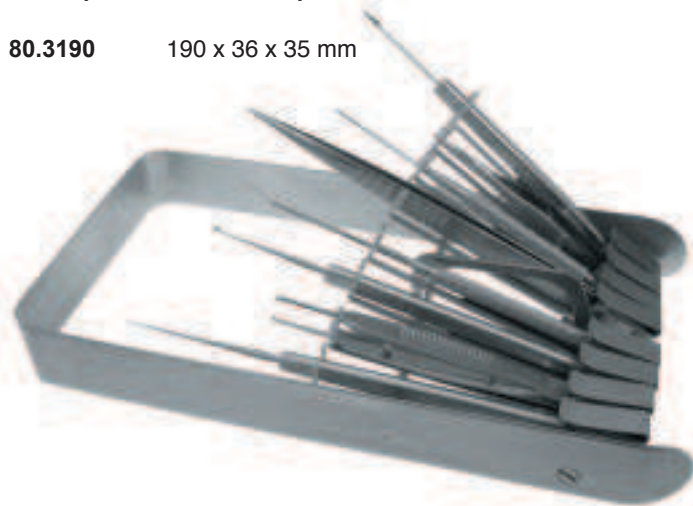

Sterilisation · Sterilization · Sterilisation · Esterilizacion · Sterilizzazione

Container für mikrochirurgische Instrumente
Containers for microsurgical instruments
Containers pour instruments de microchirurgie
Contenedores para instrumental microcirugia
Contenitori per strumenti per microchirurgia



80.3112 300x220x55 mm
80.3114 285x280x55 mm
80.3116 400x290x55 mm



80.3162 300x220x75 mm
80.3164 285x280x75 mm
80.3166 400x290x75 mm

Sterilisiertrommeln
Sterilizing drums
Boîtes rondes à stérilisation
Tambores de esterilización
Cestelli rotondi per sterilizzazione



**80.4002-
80.4028**



**80.4040-
80.4064**

SCHIMMELBUSCH

80.4002	120x120 mm	80.4016	240x240 mm
80.4004	140x140 mm	80.4018	290x160 mm
80.4006	160x120 mm	80.4020	290x240 mm
80.4008	160x150 mm	80.4022	340x160 mm
80.4010	190x150 mm	80.4024	340x240 mm
80.4012	190x190 mm	80.4026	390x190 mm
80.4014	240x160 mm	80.4028	390x290 mm

KONRICH

80.4040	96 x 99 mm	80.4054	285 x 240 mm
80.4042	156 x 146 mm	80.4056	334 x 158 mm
80.4044	188 x 140 mm	80.4058	334 x 238 mm
80.4046	188 x 185 mm	80.4060	384 x 138 mm
80.4048	239 x 160 mm	80.4062	384 x 188 mm
80.4050	239 x 240 mm	80.4064	384 x 288 mm
80.4052	285 x 160 mm		

Zubehör · Accessories · Accessoires · Accesorios · Accessori

Pflegeöl für chirurgische Instrumente
Lubricating Oil for Surgical Instruments
Huile pour lubrifier les instruments chirurgicaux
Lubrificante para las instrumentos quirúrgicos
Olio per lubrificazione di strumenti chirurgici

80.0010 50 cc.
80.0012 250 cc.
80.0014 1000 cc.



80.0010

Wattespender
Cotton dispensers
Distributeurs de coton
Dispensores de algodón
Distributore del cotone

80.1000 75 x 50 Ø
80.1002 115 x 75 Ø



80.1000-
80.1002

Watteabfallbehälter
Cotton Waste Collector
Poubelle pour coton
Recipiente para algodón
Recipiente per cotone usato

80.1010 75 x 50 Ø
80.1012 100 x 75 Ø



80.1010-
80.1012

Nadeldosen
Needle Cases
Boîtes à aiguilles
Estuches para agujas
Astucci per aghi

80.2000 65x17 mm
komplett - complete - complet - completo - completo

80.2009 Innendose allein für 80.2000
insert only for 80.2000
boîte intérieure seulement pour 80.2000
Caja interior suelta para 80.2000
Scatola interna sola per 80.2000



80.2000



80.2009

Zubehör · Accessories · Accessoires · Accesorios · Accessori

80.2020 150x95x13 mm



80.2020

80.2030 50x25x4,5 mm

80.2031 65x42x8,0 mm

80.2032 75x25x4,5 mm

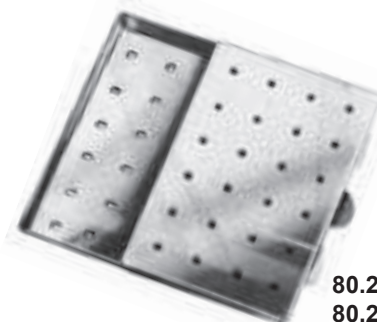

80.2030-
80.2032

SAUERBRUCH

80.2060



80.2060

Meßbecher
Measuring jugs
Gobelets gradués
Copas graduadas
Misurini

80.2070 0,25 l.

80.2072 0,5 l.

80.2074 1,0 l.

80.2076 1,5 l.

80.2078 2,0 l.



80.2070 -
80.2090

Petrischale
Petri Dish
Boîte de Petri
Cubeta de Petri
Scodella di Petri

80.2090 100 X 20 mm



80.2090

Zubehör · Accessories · Accessoires · Accesorios · Accessori

**Nierenschalen
 Kidney bowls
 Bassins réniformes
 Riñoneras
 Padelle reniformi**

80.2100	170 x 37 mm
80.2101	205 x 45 mm
80.2102	250 x 39 mm
80.2104	275 x 45 mm



**80.2100 -
 80.2104**

**Runde Schalen
 Round Bowls
 Cuvettes rondes
 Cubetas redondas
 Scodelle rotonde**

80.2200	40 x 19 mm	0,05 l
80.2202	60 x 30 mm	0,07 l
80.2204	80 x 40 mm	0,14 l
80.2206	100 x 50 mm	0,20 l
80.2208	120 x 55 mm	0,35 l
80.2210	150 x 65 mm	0,70 l



**80.2200 -
 80.2210**



**80.2240 -
 80.2262**

80.2240	150 x 74 mm	0,75 l
80.2242	160 x 65 mm	1,00 l
80.2244	220 x 70 mm	2,00 l
80.2246	225 x 90 mm	2,50 l
80.2248	240 x 95 mm	3,00 l
80.2250	255 x 115 mm	4,00 l
80.2252	260 x 130 mm	4,50 l
80.2254	300 x 105 mm	6,00 l
80.2256	310 x 120 mm	6,00 l
80.2258	320 x 140 mm	8,00 l
80.2260	380 x 125 mm	11,00 l
80.2262	400 x 150 mm	14,00 l

**Kappenzangen mit Behälter und Deckel
 Sterilizing Forceps with jar and lid
 Pinces à stérilisation avec éprouvette et couvercle
 Pinzas para esterilización con recipiente y tapa
 Pinze per sterilizzazione con recipiente e coperchio**

80.2270	25 cm
80.2272	32 cm



**80.2270 -
 80.2272**

Zubehör · Accessories · Accessoires · Accesorios · Accessori

Standgefäße

Jars

Réipients cylindriques

Tarros

Recipienti cilindrici

80.2280	30 x 90 mm
80.2282	50 x 100 mm
80.2284	50 x 135 mm
80.2286	50 x 180 mm
80.2288	80 x 130 mm
80.2290	80 x 180 mm
80.2292	100 x 200 mm



80.2280 -
80.2292

Medizinbecher und -löffel

Medicine Cups and Spoons

Gobelets et cuillère à médicaments

Vasos y cuchara para medicamentos

Bicchieri e cucchiaio per medicinali

80.2300	30 cc
80.2302	50 cc



80.2300



80.2302

80.2310	6,8 x 1,8 cm
---------	--------------



80.2310

80.2315	11 x 2 cm
---------	-----------



80.2315

Zubehör · Accessories · Accessoires · Accesorios · Accessori

Instrumenttenablegeplatten
Instrument depositing trays
Plateaux pour déposer les instruments
Bandejas para instrumentos
Vassoi per strumenti

80.2400	210 x 160 x 10 mm
80.2401	240 x 180 x 10 mm
80.2402	310 x 150 x 10 mm
80.2406	310 x 210 x 10 mm
80.2407	400 x 270 x 20 mm
80.2408	420 x 280 x 10 mm

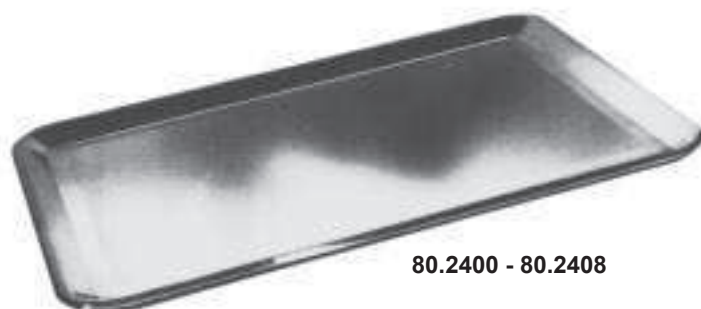

80.2400 - 80.2408

80.2430	230 x 155 x 30 mm
80.2432	300 x 175 x 30 mm
80.2434	300 x 175 x 40 mm
80.2436	350 x 240 x 36 mm
80.2438	400 x 300 x 50 mm



80.2400 - 80.2408

Instrumentenkästen
Instrument Boxes
Boîtes à Instruments
Cajas para instrumentos
Cestelli per strumenti

80.4100	16x10x 3 cm
80.4101	20x10x 5 cm
80.4102	22x15x 5 cm
80.4103	26x15x 5 cm
80.4104	30x20x 5 cm



80.4100 - 80.4104