

LARYNGO-BRONCHO-OESOPHAGOSKOPIE  
LARYNGO-BRONCHO-ESOPHAGOSCOPY  
LARYNGO-BRONCHO-OESOPHACOSCOPIE  
LARINGO-BRONCO-ESOFAGOSCOPIA  
LARINGO-BRONCO-ESOFAGOSCOPIA





- |                |                |                |
|----------------|----------------|----------------|
| <b>35.0008</b> | # 000 = 6 mm Ø | <b>35.0028</b> |
| <b>35.0009</b> | # 00 = 8 mm Ø  | <b>35.0029</b> |
| <b>35.0010</b> | # 0 = 10 mm Ø  | <b>35.0030</b> |
| <b>35.0011</b> | # 1 = 12 mm Ø  | <b>35.0031</b> |
| <b>35.0012</b> | # 2 = 14 mm Ø  | <b>35.0032</b> |
| <b>35.0013</b> | # 3 = 16 mm Ø  | <b>35.0033</b> |
| <b>35.0014</b> | # 4 = 18 mm Ø  | <b>35.0034</b> |
| <b>35.0015</b> | # 5 = 20 mm Ø  | <b>35.0035</b> |
| <b>35.0016</b> | # 6 = 22 mm Ø  | <b>35.0036</b> |
| <b>35.0017</b> | # 7 = 24 mm Ø  | <b>35.0037</b> |
| <b>35.0018</b> | # 8 = 26 mm Ø  | <b>35.0038</b> |
| <b>35.0019</b> | # 9 = 28 mm Ø  | <b>35.0039</b> |
| <b>35.0020</b> | # 10 = 30 mm Ø | <b>35.0040</b> |



**35.0045**



**35.0047**

Griff / handle / manche / mango / manico



**MICHEL**  
25 cm



**35.0050**  
10 mm



**35.0051**  
12 mm



**35.0052**  
14 mm



**35.0053**  
16 mm



**35.0054**  
18 mm

Rhinoskopiespiegel  
 Rhinoscopic mirrors  
 Mirrors rhinoscopiques  
 Espejos rinoscópicos  
 Specchi per rinoscopia

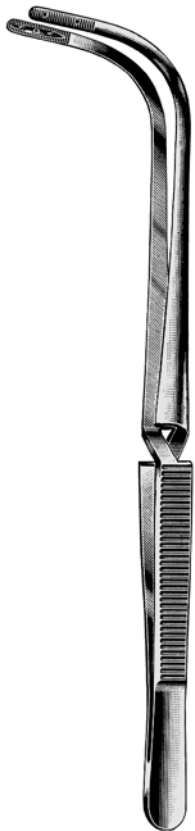

# 1  
35.0100

Tamponpinzetten  
 Tampon Forceps  
 Pincas porte-tampons  
 Pinzas porta tampones  
 Pinze per tamponi

**JACKSON**  
22 cm



# 2  
35.0105

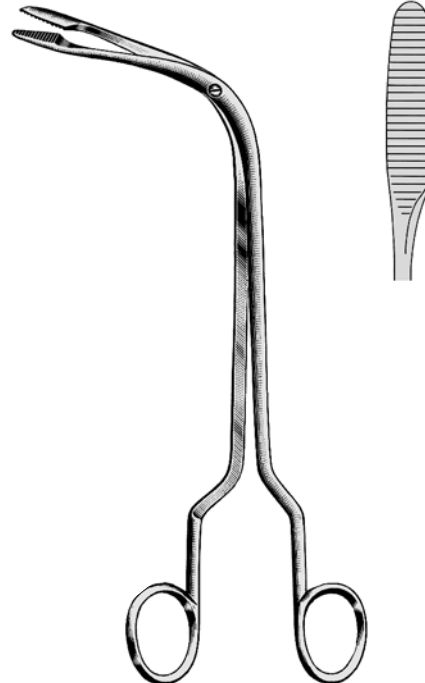

**FRAENKEL**  
35.0110  
18 cm



# 1  
35.0120

nach rechts öffnend / opening right / ouvrant à la droite /  
 abriendo hacia derecha / aprendo a destra



# 2  
35.0121

nach links öffnend / opening left / ouvrant à la gauche /  
 abriendo hacia izquierda / aprendo a sinistra



# 3  
35.0122

nach unten öffnend / opening downward / ouvrant en bas /  
 abriendo hacia abajo / aprendo in basso



# 4  
35.0123

nach oben öffnend / opening upward / ouvrant en haut /  
 abriendo hacia arriba / aprendo in aldo



**JURASZ**  
23 cm

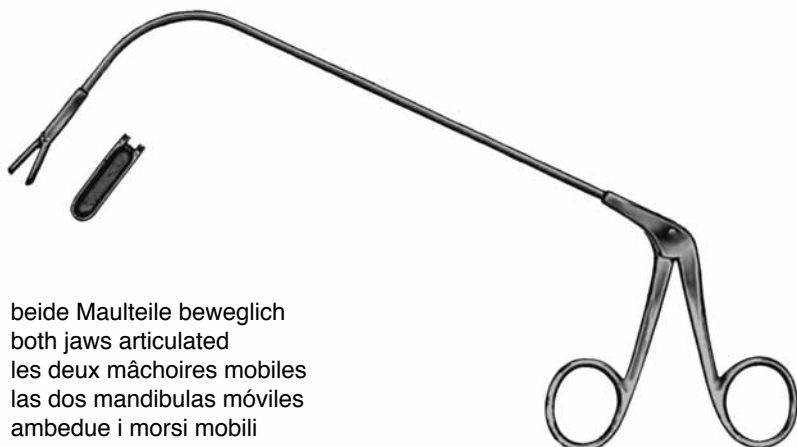

beide Maulteile beweglich  
both jaws articulated  
les deux mâchoires mobiles  
las dos mandibulas móviles  
ambedue i morsi mobili

**FRAENKEL**  
35.0125

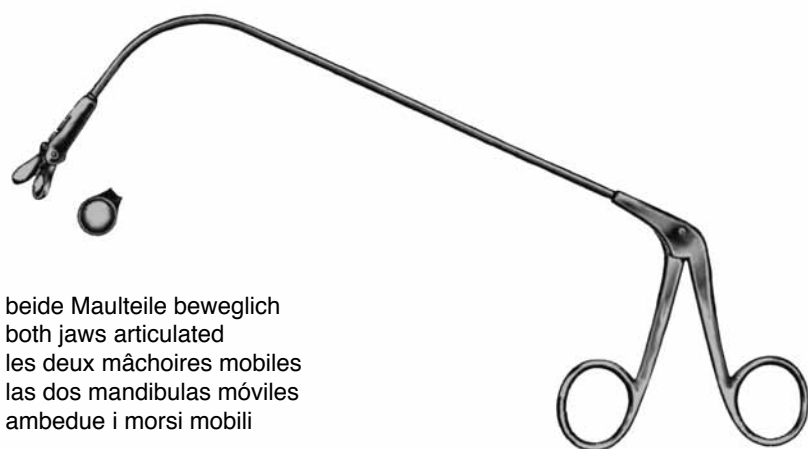

beide Maulteile beweglich  
both jaws articulated  
les deux mâchoires mobiles  
las dos mandibulas móviles  
ambedue i morsi mobili

**LANGE**  
35.0127



Kehlkopfdeckelhalter  
Epiglottis retractor  
Dépresseur de l'épiglottis  
Depresor para épiglotis  
Depressore epiglottico

**REICHERT**  
35.0130  
23 cm

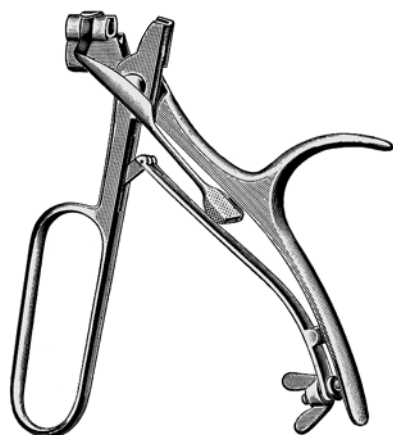

**HUBER**  
35.0200

Universalgriff für Verlängerungsrohre 35.0220 - 35.0320  
Universal Handle for extension tubes 35.0220 - 35.0320  
Manche universel pour tubes de rallonge 35.0220 - 35.0320  
Mango universal para tubos de extension 35.0220 - 35.0320  
Manico universale per tubi allunghi 35.0220 - 35.0320



Verlängerungsrohre  
Extension Tubes  
Tubes-rallonges  
Tubos alargaderos  
Tubi-allunghi

- BRUENINGS**  
35.0220 20 cm  
35.0230 30 cm  
35.0240 40 cm  
35.0250 50 cm  
35.0260 60 cm



**BRUENINGS**  
35.0320  
20 cm

AUSWECHSELBARE ZANGENAUFsätze / EXCHANGEABLE TIPS / EMBOUTS INTERCHANGEABLES  
PINZAS INTECAMBIABLES / PINZE INTERCAMBIABILI



**FRAENKEL**  
35.0400



**SEIFFERT**  
35.0405



**FRAENKEL**  
35.0420



**LANGE**  
35.0430



- BRUENINGS**  
● 35.0440 2 mm  
● 35.0442 3 mm  
● 35.0444 4 mm



- BRUENINGS**  
● 35.0445  
3 mm



- BRUENINGS**  
○ 35.0446 2 mm  
○ 35.0448 3 mm



**SCHEINMANN**  
35.0450



**SCHEINMANN**  
35.0452

AUSWECHSELBARE ZANGENAUFsätze / EXCHANGEABLE TIPS / EMBOUTS INTERCHANGEABLES  
PINZAS INTECAMBIABLES / PINZE INTERCAMBIABILI



**KRAUSE**  
35.0460 #1



35.0461 #2



**KRAUSE**  
35.0465



**SCHUMACHER**  
35.0468



**CORDES**  
35.0485 #1



35.0486 #2



**CORDES**  
35.0487



**CORDES**  
35.0488 #1, 3 mm



35.0489 #2, 4 mm



35.0490 #3, 5 mm



35.0491 #4, 8 mm





**ROSENBERG**  
35.0495

Längen / Lengths / Longueurs / Largos / Lunghezze





**CHEVALIER-JACKSON**  
 35.0603 – 35.0716

- #1
-  **35.0603** 30 cm
  - 35.0604** 40 cm
  - 35.0605** 50 cm
  - 35.0606** 60 cm

- #2
-  **35.0623** 30 cm
  - 35.0624** 40 cm
  - 35.0625** 50 cm
  - 35.0626** 60 cm

- #4
-  **35.0653** 30 cm
  - 35.0654** 40 cm
  - 35.0655** 50 cm
  - 35.0656** 60 cm

- #6
-  **35.0703** 30 cm
  - 35.0704** 40 cm
  - 35.0705** 50 cm
  - 35.0706** 60 cm

- #3
-  **35.0643** 30 cm
  - 35.0644** 40 cm
  - 35.0645** 50 cm
  - 35.0646** 60 cm

- #5
-  **35.0663** 30 cm
  - 35.0664** 40 cm
  - 35.0665** 50 cm
  - 35.0666** 60 cm

- #7
-  **35.0713** 30 cm
  - 35.0714** 40 cm
  - 35.0715** 50 cm
  - 35.0716** 60 cm



**JACKSON**  
**35.0750**  
 30 cm Ø 2,0 mm  
**35.0752**  
 35 cm Ø 2,5 mm  
**35.0754**  
 50 cm Ø 4,0 mm  
**35.0756**  
 55 cm Ø 4,0 mm



**ASPIRATION**  
**35.0760**  
 25 cm Ø 2,0 mm  
**35.0762**  
 25 cm Ø 2,5 mm  
**35.0764**  
 25 cm Ø 3,0 mm

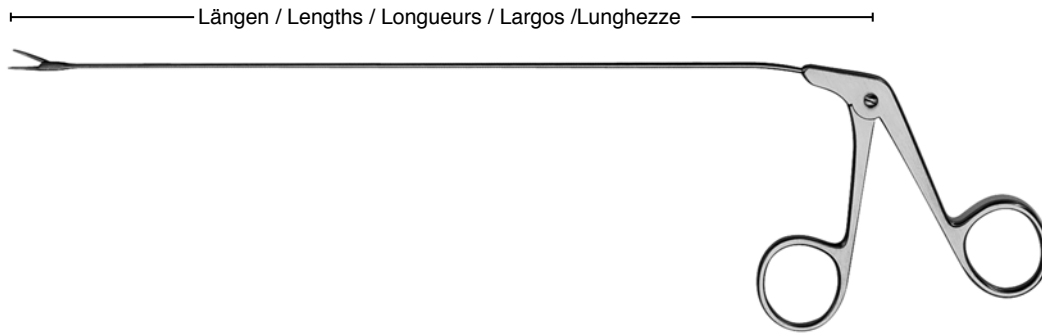

35.3600 - 35.3649

**LARYNGO-Bronchoscopy**

Schaft Ø 2,5 mm  
 Shaft Ø 2,5 mm  
 Tige Ø 2,5 mm  
 Vestago Ø 2,5 mm  
 Asta Ø 2,5 mm

	40 cm	50 cm	60 cm
	35.3600 # 0	35.3620 # 0	35.3640 # 0
	35.3601 # 1	35.3621 # 1	35.3641 # 1
	35.3602 # 2	35.3622 # 2	35.3642 # 2
	35.3603 # 3	35.3623 # 3	35.3643 # 3
	35.3604 # 4	35.3624 # 4	35.3644 # 4
	35.3605 # 5	35.3625 # 5	35.3645 # 5
	35.3606 # 6	35.3626 # 6	35.3646 # 6
	35.3607 # 7	35.3627 # 7	35.3647 # 7
	35.3608 # 8	35.3628 # 8	35.3648 # 8
	35.3609 # 9	35.3629 # 9	35.3649 # 9
	35.3610 # 10	35.3630 # 10	
	35.3611 # 11	35.3631 # 11	
	35.3612 # 12	35.3632 # 12	



## McINTOSH

### 11.1002

Besteck bestehend aus: 11.1016 Batteriegriff 30 mm (ohne Batterien), 11.1020 McIntosh Spatel Fig. 0, 11.1021 dito Fig. 1, 11.1022 dito Fig. 2, 11.1027 Etui für 3 Spateln

Set consisting of: 11.1016 Battery Handle 30 mm (without batteries), 11.1020 McIntosh Blade Fig. 0, 11.1021 dito Fig. 1, 11.1022 dito Fig. 2, 11.1027 Case for 3 blades

Trousse, composée de: 11.1016 Manche à piles 30 mm (sans piles), 11.1020 McIntosh Spatule Fig. 0, 11.1021 dito Fig. 1, 11.1022 dito Fig. 2, 11.1027 Etui pour 3 spatules

Juego compuesto de: 11.1016 Mango de pila 30 mm (sin pilas), 11.1020 McIntosh Hoja Fig. 0, 11.1021 idem Fig. 1, 11.1022 idem Fig. 2, 11.1027 Estuche para 3 hojas

Set completo composta da: 11.1016 Manico per pila 30 mm (senza pila), 11.1021 McIntosh Spatola Fig. 0, 11.1021 idem Fig. 1, 11.1022 idem Fig. 2, 11.1027 astuccio per 3 spatole

## McINTOSH

### 11.1003

Besteck bestehend aus: 11.1016 Batteriegriff (ohne Batterie), 11.1021 McINTOSH Spatel Fig. 1, 11.1022 dito Fig. 2, 11.1023 dito Fig. 3, 11.1027 Etui für 3 Spatel

Set consisting of 11.1016 Battery Handle (without batteries), 11.1021 McINTOSH Blade Fig. 1, 11.1022 dito Fig. 2, 11.1023 dito Fig. 3, 11.1027 Case for 3 blades

Trousse, composée de 11.1016 Manche à piles (sans piles), 11.1021 McINTOSH Spatule Fig. 1, 11.1022 dito Fig. 2, 11.1023 dito Fig. 3, 11.1027 Etui pour 3 spatules

Juego compuesto de: 11.1016 Mango de pila (sin pilas), 11.1021 McINTOSH Hoja Fig. 1, 11.1022 idem Fig. 2, 11.1023 idem Fig. 3, 11.1027 Estuche para 3 hojas

Set completo composto da: 11.1016 Manico per pila 30 mm (senza pila); 11.1021 McIntosh Spatola Fig. 1; 11.1022 idem Fig. 2; 11.1023 idem Fig. 3; 11.1027 astuccio per 3 spatole.



### **McINTOSH**

#### **11.1004**

Besteck bestehend aus: 11.1016 Batteriegriff (ohne Batterie), 11.1021 McINTOSH Spatel Fig. 1, 11.1022 dito Fig. 2, 11.1023 dito Fig. 3, 11.1024 dito Fig. 4 11.1028 Etui für 4 Spatel

Set consisting of 11.1016 Battery Handle (without batteries), 11.1021 McINTOSH Blade Fig. 1, 11.1022 dito Fig. 2, 11.1023 dito Fig. 3, 11.1024 dito Fig. 4, 11.1028 Case for 4 blades

Trousse, composée de 11.1016 Manche à piles (sans piles), 11.1021 McINTOSH Spatule Fig. 1, 11.1022 dito Fig. 2, 11.1023 dito Fig. 3, 11.1024 dito Fig. 4, 11.1028 Etui pour 4 spatules

Juego compuesto de: 11.1016 Mango de pila (sin pilas), 11.1021 McINTOSH Hoja Fig. 1, 11.1022 idem Fig. 2, 11.1023 idem Fig. 3, 11.1024 idem Fig. 4, 11.1028 Estuche para 4 hojas

Set completo composto da: 11.1016 Manico per pila 30 mm (senza pila); 11.1021 McIntosh Spatola Fig. 1; 11.1022 idem Fig. 2; 11.1023 idem Fig. 3; 11.1024 idem Fig. 4; 11.1028 astuccio per 4 spatole.



### **McINTOSH**

#### **11.1005**

Besteck bestehend aus: 11.1016 Batteriegriff 30 mm (ohne Batterien), 11.1020 McIntosh Spatel Fig. 0, 11.1021 dito Fig. 1, 11.1022 dito Fig. 2, 11.1023 dito Fig. 3, 11.1024 dito Fig. 4, 11.1027 Etui für 3 Spateln, Etui

Set consisting of: 11.1016 Battery Handle 30 mm (without batteries), 11.1020 McIntosh Blade Fig. 0, 11.1021 dito Fig. 1, 11.1022 dito Fig. 2, 11.1023 dito Fig. 3, 11.1024 dito Fig. 4, Case

Trousse, composée de: 11.1016 Manche à piles 30 mm (sans piles), 11.1020 McIntosh Spatule Fig. 0, 11.1021 dito Fig. 1, 11.1022 dito Fig. 2, 11.1023 dito Fig. 3, 11.1024 dito Fig. 4, Etui

Juego compuesto de: 11.1016 Mango de pila 30 mm (sin pilas), 11.1020 McIntosh Hoja Fig. 0, 11.1021 idem Fig. 1, 11.1022 idem Fig. 2, 11.1023 idem Fig. 3, 11.1024 idem Fig. 4, Estuche

Set completo composta da: 11.1016 Manico per pila 30 mm (senza pila), 11.1020 McIntosh Spatola Fig. 0, 11.1021 idem Fig. 1, 11.1022 idem Fig. 2, 11.1023 idem Fig. 3, 11.1024 idem Fig. 4, astuccio



### 11.1016

Batteriegriff 30 mm Ø (ohne Batterien)  
Battery handle 30 mm Ø (without batteries)  
Manche à pile 30 mm Ø (sans piles)  
Mango de pilas 30 mm Ø (sin pilas)  
Manico per pila 30 mm Ø (senza pila)



### 11.1017

Batteriegriff 18 mm Ø (ohne Batterien)  
Battery handle 18 mm Ø (without batteries)  
Manche à pile 18 mm Ø (sans piles)  
Mango de pilas 18 mm Ø (sin pilas)  
Manico per pila 18 mm Ø (senza pila)



### 11.1018

Ersatzbirne, klein für Spateln Fig. 0 - 1  
Spare Bulb, small for blades Fig. 0 - 1  
Ampoule de rechange, petit, pour spatules Fig. 0 - 1  
Bombilla de ricambio, pequeño, para hojas Fig. 0 - 1  
Lampadina di ricambio, piccolo, per spatole Fig. 0 - 1



### 11.1019

Ersatzbirne, groß, für Spateln Fig 2 - 4  
Spare Bulb, large, for blades Fig. 1 - 4  
Ampoule de rechange, grand, pour spatules Fig. 2 - 4  
Bombilla de ricambio, grande, para hojas Fig. 2 - 4  
Lampadina di ricambio, grande, per spatole Fig. 2 - 4



**McINTOSH**  
**11.1020**  
55 mm Fig. 0



**McINTOSH**  
**11.1021**  
75 mm Fig. 1



**McINTOSH**  
**11.1022**  
90 mm Fig. 2



**McINTOSH**  
**11.1023**  
110 mm Fig. 3



**McINTOSH**  
**11.1024**  
130 mm Fig. 4



**MILLER-BABY**

**11.1052**

Besteck bestehend aus: 11.1016 Batteriegriff (ohne Batterien),  
11.1070 MILLER-BABY Spatel Fig. 0, 11.1071 dito Fig. 1

Set consisting of: 11.1016 Battery handle (without batteries),  
11.1071 MILLER-BABY Spatula Fig. 0, 11.1071 ditto Fig. 1

Trousse, composée de: 11.1016 Manche à piles (sans piles),  
11.1070 spatule MILLER-BABY Fig. 0, 11.1071 ditto Fig. 1

Juego compuesto de: 11.1016 Mango de pilas (sin pilas),  
11.1070 hoja MILLER-BABY Fig. 0, 11.1071 idem Fig. 1

Set completo composto da: 11.1016 Manico per pila 30 mm (senza  
pila), 11.1070 MILLER-BABY spatola Fig. 0, 11.1071 idem Fig. 1



## MILLER

### 11.1063

Laryngoskop 3 Spateln Figur 1 - 3

Besteck bestehend aus: 11.1016 Batteriegriff (ohne Batterien), 11.1071 MILLER Spatel Fig. 1; 11.1072 dito Fig. 2, 11.1073 dito Fig. 3, Etui

Set consisting of: 11.1016 Battery handle (without batteries), 11.1071 MILLER Spatula Fig. 1, 11.1072 Fig. 2, 11.1073 ditto Fig. 3, case

Trousse, composée de: 11.1016 Manche à piles (sans piles), 11.1071 spatule MILLER Fig. 1, 11.1072 dito Fig. 2, 11.1073 dito Fig. 3, Etui

Juego compuesto de: 11.1016 Mango de pilas (sin pilas), 11.1071 hoja MILLER Fig. 1, 11.1072 idem Fig. 2; 11.1073 idem Fig. 3, Estuche

Set completo composto da: 11.1016 Manico per pila 30 mm (senza pila), 11.1071 MILLER spatola Fig. 1; 11.1072 idem Fig. 2, 11.1073 idem Fig. 3, astucchio

## MILLER

### 11.1064

Laryngoskop 4 Spateln Figur 1 - 4

Besteck bestehend aus: 11.1016 Batteriegriff (ohne Batterien), 11.1071 MILLER Spatel Fig. 1, 11.1072 dito Fig. 2, 11.1073 dito Fig. 3, 11.1074 dito Fig. 4, Etui

Set consisting of: 11.1016 Battery handle (without batteries), 11.1071 MILLER Spatula Fig. 1, 11.1072 Fig. 2, 11.1073 ditto Fig. 3, 11.1074 ditto Fig. 4, case

Trousse, composée de: 11.1016 Manche à piles (sans piles), 11.1071 spatule MILLER Fig. 1, 11.1072 dito Fig. 2, 11.1073 dito Fig. 3, 11.1074 dito Fig. 4, Etui

Juego compuesto de: 11.1016 Mango de pilas (sin pilas), 11.1071 hoja MILLER Fig. 1, 11.1072 idem Fig. 2, 11.1073 idem Fig. 3, 11.1074 idem Fig. 4, Estuche

Set completo composto da: 11.1016 Manico per pila 30 mm (senza pila), 11.1071 MILLER spatola Fig. 1, 11.1072 idem Fig. 2, 11.1073 idem Fig. 3, 11.1074 idem Fig. 4, astucchio

## MILLER

### 11.1065

Laryngoskop 5 Spateln Figur 0 - 4

Besteck bestehend aus: 11.1016 Batteriegriff (ohne Batterien), 11.1070 MILLER Spatel Fig. 0; 11.1071 dito Fig. 1, 11.1072 dito Fig. 2, 11.1073 dito Fig. 3, 11.1074 dito Fig. 4, Etui

Set consisting of: 11.1016 Battery handle (without batteries), 11.1070 MILLER Spatula Fig. 0, 11.1071 Fig. 1, 11.1072 Fig. 2, 11.1073 ditto Fig. 3, 11.1074 ditto Fig. 4, case

Trousse, composée de: 11.1016 Manche à piles (sans piles), 11.1070 spatule MILLER Fig. 0, 11.1071 dito Fig. 1, 11.1072 dito Fig. 2, 11.1073 dito Fig. 3, 11.1074 dito Fig. 4, Etui

Juego compuesto de: 11.1016 Mango de pilas (sin pilas), 11.1070 hoja MILLER Fig. 0, 11.1071 idem Fig. 1, 11.1072 idem Fig. 2, 11.1073 idem Fig. 3, 11.1074 idem Fig. 4, Estuche

Set completo composto da: 11.1016 Manico per pila 30 mm (senza pila), 11.1070 MILLER spatola Fig. 0, 11.1071 idem Fig. 1, 11.1072 idem Fig. 2, 11.1073 idem Fig. 3, 11.1074 idem Fig. 4, astucchio



**11.1016**  
30 mm Ø  
ohne Batterien  
without batteries  
sans piles  
sin pilas  
senza pila



**MILLER-BABY**  
**11.1070**  
55 mm Fig. 0



**MILLER-BABY**  
**11.1071**  
80 mm Fig. 1



**MILLER**  
**11.1072**  
130 mm Fig. 2



**MILLER**  
**11.1073**  
170 mm Fig. 3



**MILLER**  
**11.1074**  
180 mm Fig. 4



**WISCONSIN-FOREGGER**  
**11.1103**

Laryngoskop 3 Spateln  
Besteck bestehend aus: 11.1016 Batteriegriff (ohne Batterien), 11.1111 Foregger Spatel Fig. 1, 11.1112 dito Fig. 2, 11.1113 dito Fig. 3, Etui

Set consisting of: 11.1016 Battery handle (without batteries), 11.1111 Foregger Spatula Fig. 1, 11.1112 Fig. 2, 11.1113 ditto Fig. 3, case

Trousse, composée de: 11.1016 Manche à piles (sans piles), 11.1111 spatule Foregger Fig. 1, 11.1112 dito Fig. 2, 11.1113 dito Fig. 3, Etui

Juego compuesto de: 11.1016 Mango de pilas (sin pilas), 11.1111 hoja Foregger Fig. 1, 11.1112 idem Fig. 2, 11.1113 idem Fig. 3, Estuche

Set completo composto da: 11.1016 Manico per pila 30 mm (senza pila), 11.1111 Foregger spatola Fig. 1, 11.1112 idem Fig. 2, 11.1113 idem Fig. 3, astucchio



**WISCONSIN-FOREGGER**  
**11.1104**

Laryngoskop 4 Spateln  
Besteck bestehend aus: 11.1016 Batteriegriff (ohne Batterien), 11.1111 Foregger Spatel Fig. 1, 11.1112 dito Fig. 2, 11.1113 dito Fig. 3, 11.1114 dito Fig. 4, Etui

Set consisting of: 11.1016 Battery handle (without batteries), 11.1111 Foregger Spatula Fig. 1, 11.1112 Fig. 2, 11.1113 ditto Fig. 3, 11.1114 ditto Fig. 4, case

Trousse, composée de: 11.1016 Manche à piles (sans piles), 11.1111 spatule Foregger Fig. 1, 11.1112 dito Fig. 2, 11.1113 dito Fig. 3, 11.1114 dito Fig. 4, Etui

Juego compuesto de: 11.1016 Mango de pilas (sin pilas), 11.1111 hoja Foregger Fig. 1, 11.1112 idem Fig. 2, 11.1113 idem Fig. 3, 11.1114 idem Fig. 4, Estuche

Set completo composto da: 11.1016 Manico per pila 30 mm (senza pila), 11.1111 Foregger spatola Fig. 1, 11.1112 idem Fig. 2, 11.1113 idem Fig. 3, 11.1114 idem Fig. 4, astucchio



**WISCONSIN-FOREGGER**  
**11.1111**

70 mm Fig. 1



**WISCONSIN-FOREGGER**  
**11.1112**

90 mm Fig. 2



**WISCONSIN-FOREGGER**  
**11.1113**

110 mm Fig. 3



**WISCONSIN-FOREGGER**  
**11.1114**

135 mm Fig. 4





**GEUDEL-NEGUS  
11.1123**

Laryngoskop 3 Spateln  
Besteck bestehend aus: 11.1016 Batteriegriff (ohne Batterien), 11.1132 Geudel-Negus Spatel Fig. 2, 11.1133 dito Fig. 3, 11.1134 dito Fig. 4, Etui

Set consisting of: 11.1016 Battery handle (without batteries), 11.1132 Geudel-Negus Spatula Fig. 2, 11.1133 Fig. 3, 11.1134 ditto Fig. 4, case

Trousse, composée de: 11.1016 Manche à piles (sans piles), 11.1132 spatule Geudel-Negus Fig. 2, 11.1133 ditto Fig. 3, 11.1134 ditto Fig. 4, Etui

Juego compuesto de: 11.1016 Mango de pilas (sin pilas), 11.1132 hoja Geudel-Negus Fig. 2, 11.1133 idem Fig. 3, 11.1134 idem Fig. 4, Estuche

Set completo composto da: 11.1016 Manico per pila 30 mm (senza pila), 11.1132 Geudel-Negus spatola Fig. 2, 11.1133 idem Fig. 3, 11.1134 idem Fig. 4, astucchio



**GEUDEL-NEGUS  
11.1124**

Laryngoskop 4 Spateln  
Besteck bestehend aus: 11.1016 Batteriegriff (ohne Batterien), 11.1131 Geudel-Negus Spatel Fig. 1, 11.1132 ditto Fig. 2, 11.1133 ditto Fig. 3, 11.1134 ditto Fig. 4, Etui

Set consisting of: 11.1016 Battery handle (without batteries), 11.1131 Geudel-Negus Spatula Fig. 1, 11.1132 ditto Fig. 2, 11.1133 Fig. 3, 11.1134 ditto Fig. 4, case

Trousse, composée de: 11.1016 Manche à piles (sans piles), 11.1131 spatule Geudel-Negus Fig. 1, 11.1132 ditto Fig. 2, 11.1133 ditto Fig. 3, 11.1134 ditto Fig. 4, Etui

Juego compuesto de: 11.1016 Mango de pilas (sin pilas), 11.1131 hoja Geudel-Negus Fig. 1, 11.1132 idem Fig. 2, 11.1133 idem Fig. 3, 11.1134 idem Fig. 4, Estuche

Set completo composto da: 11.1016 Manico per pila 30 mm (senza pila), 11.1131 Geudel-Negus spatola Fig. 1, 11.1132 idem Fig. 2, 11.1133 idem Fig. 3, 11.1134 idem Fig. 4, astucchio

**GEUDEL-NEGUS  
11.1131**

70 mm Fig. 1



**GEUDEL-NEGUS  
11.1133**

110 mm Fig. 3



**GEUDEL-NEGUS  
11.1132**

90 mm Fig. 2



**GEUDEL-NEGUS  
11.1134**

135 mm Fig. 4





## McINTOSH

### 11.2003

Laryngoskop 3 Spateln

Besteck bestehend aus: 11.2016 Batteriegriff (ohne Batterien), 11.2021 McINTOSH Spatel Fig. 1, 11.2022 dito Fig. 2, 11.2023 dito Fig. 3, 11.1027 Etui

Set consisting of: 11.2016 Battery handle (without batteries), 11.2021 McINTOSH Spatula Fig. 1, 11.2022 Fig. 2, 11.2023 dito Fig. 3, 11.1027 case

Trousse, composée de: 11.2016 Manche à piles (sans piles), 11.2021 spatule McINTOSH Fig. 1, 11.2022 dito Fig. 2, 11.2023 dito Fig. 3, 11.1027 Etui

Juego compuesto de: 11.2016 Mango de pilas (sin pilas), 11.021 hoja McINTOSH Fig. 1, 11.2022 idem Fig. 2, 11.2023 idem Fig. 3, 11.1027 Estuche

Set completo composto da: 11.2016 Manico per pila 30 mm (senza pila), 11.2021 McINTOSH spatola Fig. 1, 11.2022 idem Fig. 2, 11.2023 idem Fig. 3, 11.1027 astucchio

## McINTOSH

### 11.2004

Laryngoskop 4 Spateln

Besteck bestehend aus: 11.2016 Batteriegriff (ohne Batterien), 11.2021 McINTOSH Spatel Fig. 1, 11.2022 dito Fig. 2, 11.2023 dito Fig. 3, 11.2024 dito Fig. 4; 11.1027 Etui

Set consisting of: 11.2016 Battery handle (without batteries), 11.2021 McINTOSH Spatula Fig. 1, 11.2022 Fig. 2, 11.2023 dito Fig. 3, 11.2024 dito Fig. 4, 11.1027 case

Trousse, composée de: 11.2016 Manche à piles (sans piles), 11.2021 spatule McINTOSH Fig. 1, 11.2022 dito Fig. 2, 11.2023 dito Fig. 3, 11.2024 dito Fig. 4, 11.1027 Etui

Juego compuesto de: 11.2016 Mango de pilas (sin pilas), 11.021 hoja McINTOSH Fig. 1, 11.2022 idem Fig. 2, 11.2023 idem Fig. 3, 11.2024 idem Fig. 4; 11.1027 Estuche

Set completo composto da: 11.2016 Manico per pila 30 mm (senza pila), 11.2021 McINTOSH spatola Fig. 1, 11.2022 idem Fig. 2, 11.2023 idem Fig. 3, 11.2024 idem Fig. 4, 11.1027 astucchio



### 11.2016

Batteriegriff 30 mm Ø (ohne Batterien)

Battery handle 30 mm Ø (without batteries)

Manche à pile 30 mm Ø (sans piles)

Mango de pilas 30 mm Ø (sin pilas)

Manico per pila 30 mm Ø (senza pila)



**11.2016**

Batteriegriff 30 mm Ø (ohne Batterien)  
Battery handle 30 mm Ø (without batteries)  
Manche à pile 30 mm Ø (sans piles)  
Mango de pilas 30 mm Ø (sin pilas)  
Manico per pila 30 mm Ø (senza pila)



**11.2018**

Kaltlicht-Ersatzlampe  
Fiber optic spare bulb  
lumière froide Ampoule de rechange  
luz fria bombilla de ricambio  
luce fredda lampadina di ricambio



**McINTOSH**

**11.2020**

55 mm Fig. 0



**McINTOSH**

**11.2021**

70 mm Fig. 1



**McINTOSH**

**11.2022**

90 mm Fig. 2



**McINTOSH**

**11.2023**

105 mm Fig. 3



**McINTOSH**

**11.2024**

130 mm Fig. 4



## MILLER

### 11.2063

Laryngoskop 3 Spateln

Besteck bestehend aus: 11.2016 Batteriegriff (ohne Batterien), 11.2071 Miller Spatel Fig. 1, 11.2072 dito Fig. 2, 11.2073 dito Fig. 3, Etui

Set consisting of: 11.2016 Battery handle (without batteries), 11.2071 Miller Spatula Fig. 1, 11.2072 Fig. 2, 11.2073 ditto Fig. 3, case

Trousse, composée de: 11.2016 Manche à piles (sans piles), 11.2071 spatule Miller Fig. 1, 11.2072 dito Fig. 2, 11.2073 dito Fig. 3, Etui

Juego compuesto de: 11.2016 Mango de pilas (sin pilas), 11.071 hoja Miller Fig. 1, 11.2072 idem Fig. 2, 11.2073 idem Fig. 3, Estuche

Set completo composto da: 11.2016 Manico per pila 30 mm (senza pila), 11.2071 Miller spatola Fig. 1, 11.2072 idem Fig. 2, 11.2073 idem Fig. 3, astucchio

## MILLER

### 11.2064

Laryngoskop 4 Spateln

Besteck bestehend aus: 11.2016 Batteriegriff (ohne Batterien), 11.2071 Miller Spatel Fig. 1, 11.2072 dito Fig. 2, 11.2073 dito Fig. 3, 11.2073 dito Fig. 4, Etui

Set consisting of: 11.2016 Battery handle (without batteries), 11.2071 Miller Spatula Fig. 1, 11.2072 Fig. 2, 11.2073 ditto Fig. 3, 11.2074 ditto Fig. 4, case

Trousse, composée de: 11.2016 Manche à piles (sans piles), 11.2071 spatule Miller Fig. 1, 11.2072 dito Fig. 2, 11.2073 dito Fig. 3, 11.2074 dito Fig. 4, Etui

Juego compuesto de: 11.2016 Mango de pilas (sin pilas), 11.071 hoja Miller Fig. 1, 11.2072 idem Fig. 2, 11.2073 idem Fig. 3, 11.2074 idem Fig. 4, Estuche

Set completo composto da: 11.2016 Manico per pila 30 mm (senza pila), 11.2071 Miller spatola Fig. 1, 11.2072 idem Fig. 2, 11.2073 idem Fig. 3, 11.2074 idem Fig. 4, astucchio



**11.2016**

Batteriegriff 30 mm Ø (ohne Batterien)  
Battery handle 30 mm Ø (without batteries)  
Manche à pile 30 mm Ø (sans piles)  
Mango de pilas 30 mm Ø (sin pilas)  
Manico per pila 30 mm Ø (senza pila)



**MILLER-BABY**

**11.2070**

55 mm Fig. 0



**MILLER-BABY**

**11.2071**

80 mm Fig. 1



**MILLER**

**11.2072**

130 mm Fig. 2



**MILLER**

**11.2073**

170 mm Fig. 3



**11.2018**

Kaltlicht-Ersatzlampe  
Fiber optic spare bulb  
lumière froide Ampouule de rechange  
luz fria bombilla de ricambio  
luce fredda lampadina di ricambio



**MILLER**

**11.2074**

180 mm Fig. 4

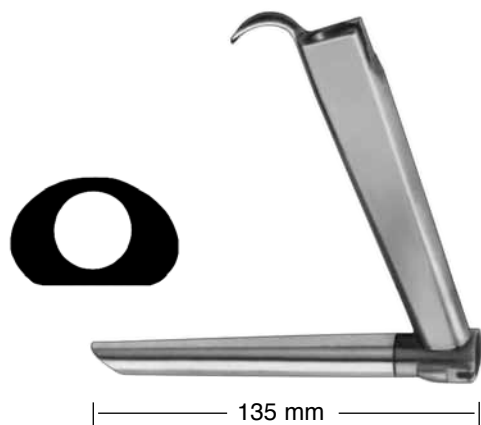

**35.2000**

135 mm

für Kinder, sehr klein

for infants, very small

pour enfants, très petite section

para niños, muy pequeño

per bambini, molto piccolo

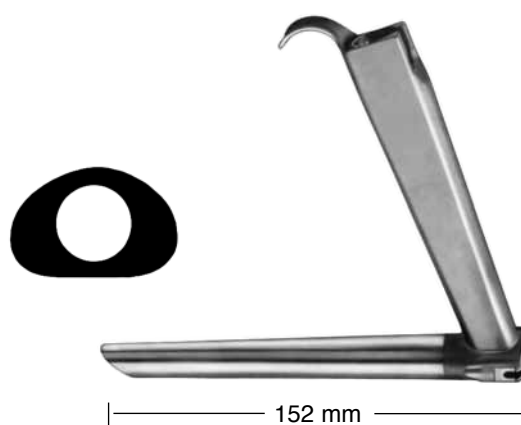

**35.2002**

152 mm

für Kinder, klein

for children, small

pour enfants, petite section

para niños, pequeño

per bambini, piccolo

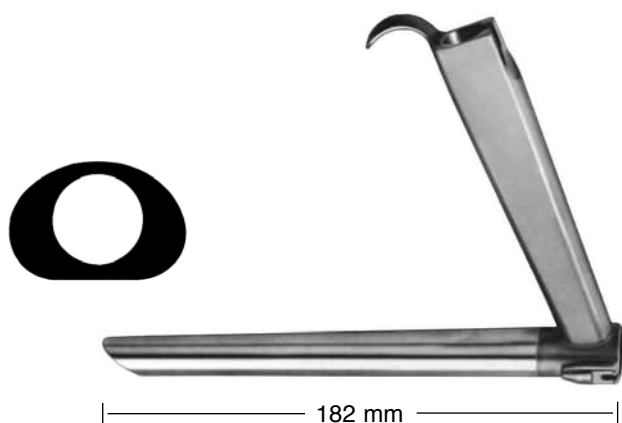

**35.2004**

182 mm

für Jugendliche, klein

for adolescents, small

pour Jeunes, petite section

para menores, pequeño

per giovane, piccolo

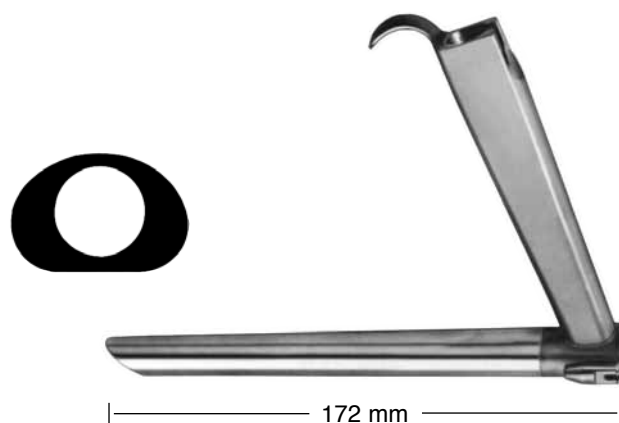

**35.2006**

172 mm

für Erwachsene, mittel

for adults, medium

pour adultes, section moyenne

para adultos, medio

per adulti, mediocre

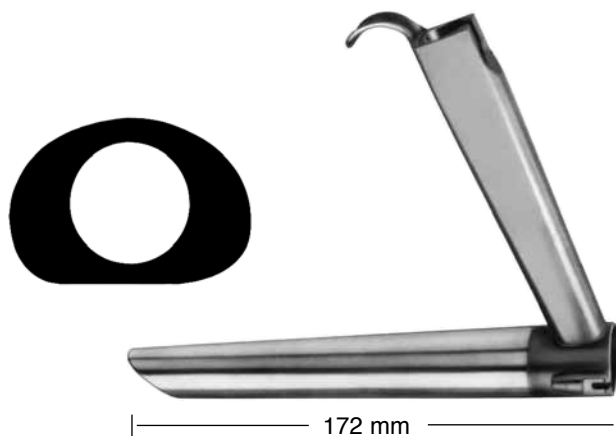

**35.2008**  
172 mm  
für Erwachsene, gross  
for adults, large  
pour adultes, section large  
para adultos, grande  
per adulti, grande

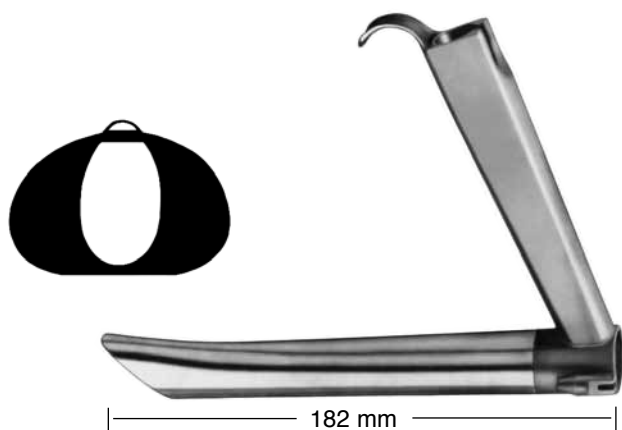

**35.2010**  
182 mm  
für Erwachsene, gross  
for adults, large  
pour adultes, section large  
para adultos, grande  
per adulti, grande

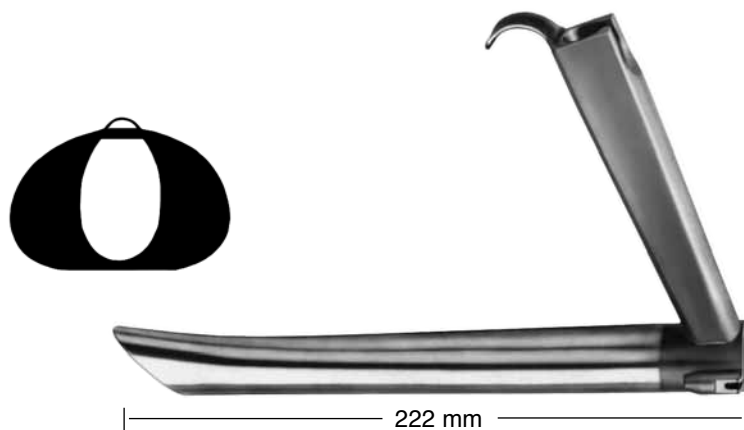

**35.2012**  
222 mm  
Hypopharyngoskop, für die vordere Kommissur  
Hypopharyngoscope, for anterior commissure  
Hypopharyngoscope, pour la commissure antérieure  
Hipofaringoscopia, para la comisura anterior  
Hipofaringoscopia, per la commissura anteriore

Unsere Fiberglass-Lichtträger werden mit Adaptern für "ACMI, STORZ, WOLF" geliefert  
Our fiberglass light carriers are supplied with "ACMI, STORZ, WOLF" adapters  
Nos Portes-fibre sont munis avec adapteurs "ACMI, STORZ, WOLF"  
Nuestros portas luz fria se entregan con adaptadores "ACMI, STORZ, WOLF"  
Nostrì condottieri di luce fredda sono corredati con un adattatore "ACMI, STORZ, WOLF"



### 35.2030

FIBERGLAS-Lichtträger für Laryngoskope 35.2000, 35.2002  
FIBERLIGHT Carrier for Laryngoscopes 35.2000, 35.2002  
PORTE FIBRE pour Spatules 35.2000, 35.2002  
PORTA Luz fria para Spatulas 35.2000, 35.2002  
Porta luce fredda per spatole 35.2000, 35.2002



### 35.2032

FIBERGLAS-Lichtträger für Laryngoskope 35.2004 - 35.2010  
FIBERLIGHT Carrier for Laryngoscopes 35.2004 - 35.2010  
PORTE FIBRE pour Spatules 35.2004 - 35.2010  
PORTA Luz fria para Spatulas 35.2004 - 35.2010  
Porta luce fredda per spatole 35.2004 - 35.2010



### 35.2040

INJEKTIONSKANÜLE für 35.2000 - 35.2010  
INJECTION CANULA for Laryngoscope 35.2000 - 35.2010  
CANULE pour injections pour 35.2000 - 35.2010  
CANULA a iniecciones para 35.2000 - 35.2010  
Cannula per iniezione per laringoscopi 35.2000 - 35.2010



### 35.2034

FIBERGLAS-Lichtträger für Laryngoskope 35.2012  
FIBERLIGHT Carrier for Laryngoscopes 35.2012  
PORTE FIBRE pour Spatules 35.2012  
PORTA Luz fria para Spatulas 35.2012  
Porta luce fredda per spatole 35.2012



### 35.2050

RAUCHABSAUGROHR für 35.2000-35.2010  
SUCTION TUBE for 35.2000 - 35.2010  
CANULE à aspiration pour 35.2000 - 35.2010  
CANUA a aspiracion para 35.2000 - 35.2010  
Cannula per aspirazione per laringoscopi 35.2000 - 35.2010

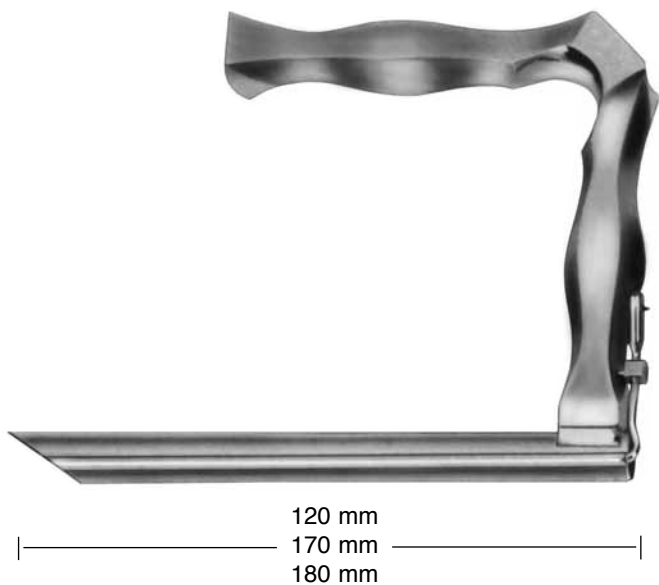

**JACKSON**  
**35.2100**  
120 mm  
für Säuglinge  
for infants  
pour nourrissons  
para lactantes  
per neonati

**JACKSON**  
**35.2102**  
170 mm  
für Kinder  
child size  
pour enfants  
para niños  
per bambini

**JACKSON**  
**35.2104**  
180 mm  
für Erwachsene  
for adults  
pour adultes  
para adultos  
per adulti

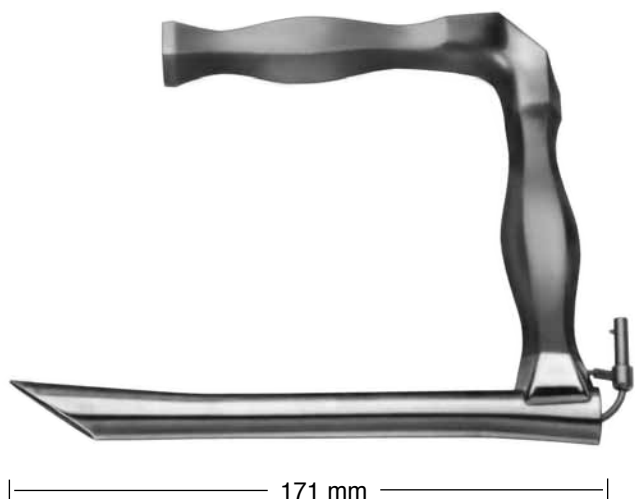

**HOLINGER**  
**35.2120**  
171 mm



### 35.2020

BRUSTSTÜTZE mit Stützstange 34 cm für Erwachsene  
Chest Support and Support-rod 34 cm for adults  
Appui pectoral avec tige 34 cm pour adultes  
Apoyo-pecho con pertiga 34 cm para adultos  
Sopporto per petto per laringoscopi per adulti 34 cm

### 35.2025

STÜTZSTANGE für Kinder 24 cm  
Support-rod for Children 24 cm  
Tige-support pour enfants 24 cm  
Pertiga-soporte para niños 24 cm  
Sopporto per petto per laringoscopi per bambini 24 cm

**PRO-MED** ist Ihnen behilflich bei der Zusammenstellung von Operationsbestecken für die verschiedensten Disziplinen. Fragen Sie nach unseren vorbereiteten OP-Bestecken.

For your convenience a wide variety of Suggested Operating Sets for most general and specialized procedures is available from **PRO-MED**. Please contact us or your local dealer.

**PRO-MED** vous propose de multiples compositions de boîtes opératoires multidisciplinaires.  
Demandez nos suggestions pour de nombreuses interventions.

**PRO-MED** le ayuda en componer varias cajas de instrumentos quirúrgicos.  
Pregunte por nuestro instrumental quirúrgico preparado.

Per la vostra comodità **PRO-MED** Vi aiuta nella raccolta di strumenti chirurgici per le varie discipline. Vi preghiamo di chiedere informazioni sui nostri set di strumenti chirurgici già preparati.