

ARTERIENKLEMMEN, PRÄPARIERKLEMMEN  
HEMOSTATIC- AND DISSECTING FORCEPS  
PINCES HEMOSTATIQUES ET A PREPARATION  
PINZAS HEMOSTATICAS Y PARA PREPARACIONES  
PINZE EMOSTATICHE E PER PREPARAZIONE

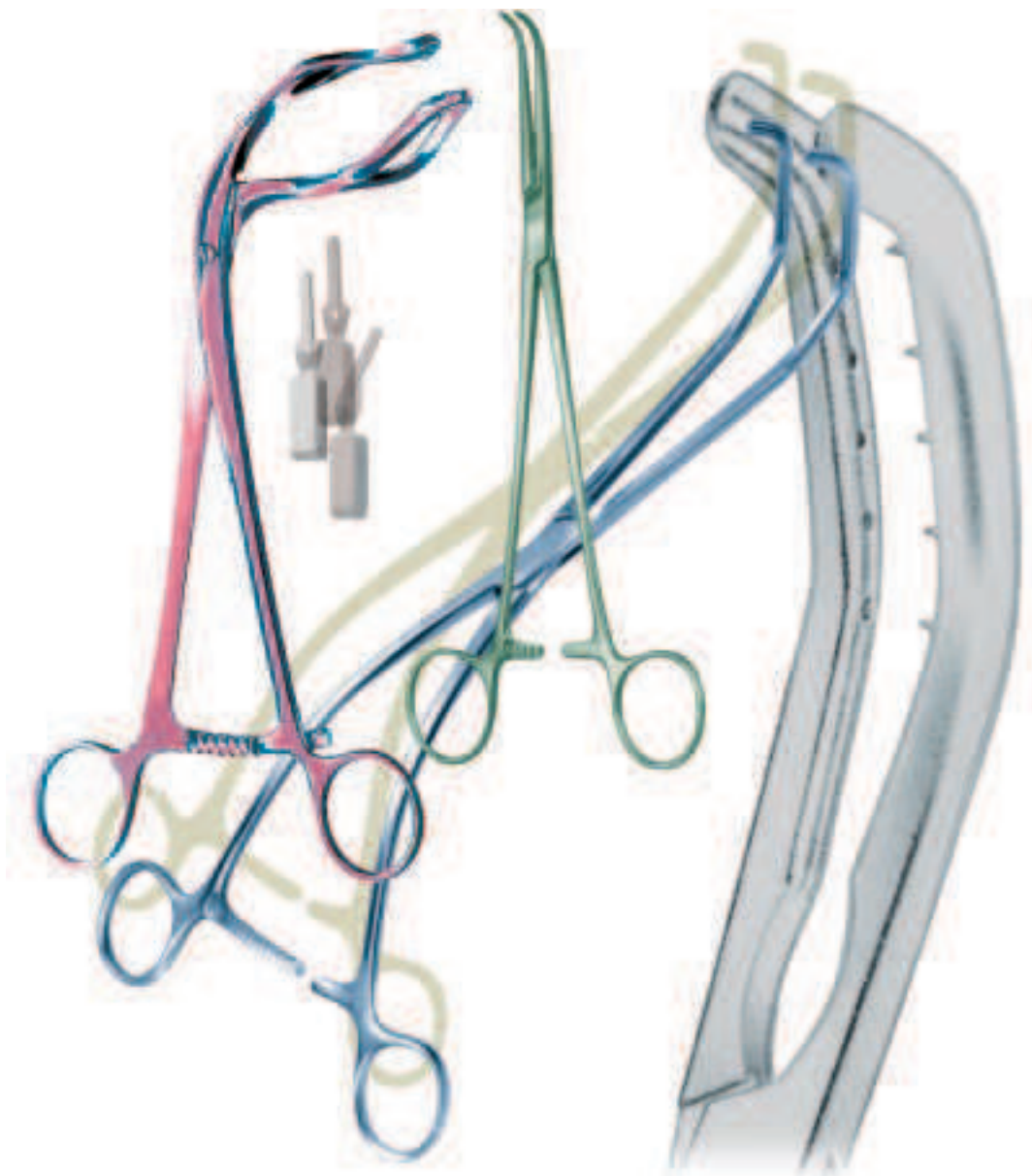

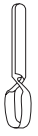

**MICRO-CLIP**  
**15.0001**  
 10 x 2 mm  
 60 gr.



**MICRO-CLIP**  
**15.0002**  
 8 x 2 mm  
 85 gr.



**MICRO-CLIP**  
**15.0003**  
 6 x 1 mm  
 100 gr.



**MICRO-CLIP**  
**15.0004**  
 4 x 0,75 mm  
 125 gr.



**MICRO-CLIP**  
**15.0005**  
 6 x 1 mm  
 45°, 70 gr.



**MICRO-CLIP**  
**15.0006**  
 6 x 1 mm  
 70 gr.



**15.0008** 14 cm



**15.0009** 18 cm

Anlegezangen  
 applying forceps  
 pinces à appliquer  
 pinzas para poner  
 pinze per applicare



**JOHNS-HOPKINS**  
**15.0040** 23 cm  
 Anlegezange  
 applying forceps  
 pince à appliquer  
 pinza para poner  
 pinza per applicare



**DIEFFENBACH**  
**15.0010** 3,5 cm



**DIEFFENBACH**  
**15.0011** 3,5 cm



**DIEFFENBACH**  
**15.0012** 5 cm



**DIEFFENBACH**  
**15.0013** 5 cm



**DIEFFENBACH**  
**15.0014** 6 cm

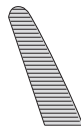

**DIEFFENBACH**  
**15.0015** 6 cm



**JOHNS-HOPKINS**  
**15.0020** 38 mm  
**15.0022** 50 mm  
**15.0024** 57 mm  
**15.0026** 63 mm  
**15.0028** 70 mm  
**15.0030** 76 mm  
**15.0032** 90 mm



**JOHNS-HOPKINS**  
**15.0021** 38 mm  
**15.0023** 50 mm  
**15.0025** 57 mm  
**15.0027** 63 mm  
**15.0029** 70 mm  
**15.0031** 76 mm  
**15.0033** 90 mm



**SCHWARTZ**  
15.0050 25 mm



**SCHWARTZ**  
15.0051 25 mm



**SCHWARTZ**  
15.0053 25 mm



**SCHWARTZ**  
15.0058 19 cm

Anlegezange  
Applying forceps  
pince à appliquer  
pinza para poner  
pinza per applicare



**MINI-SERREFINE**  
15.0060 28 mm



**MINI-SERREFINE**  
15.0061 28 mm



**GLOVER**



**GLOVER**

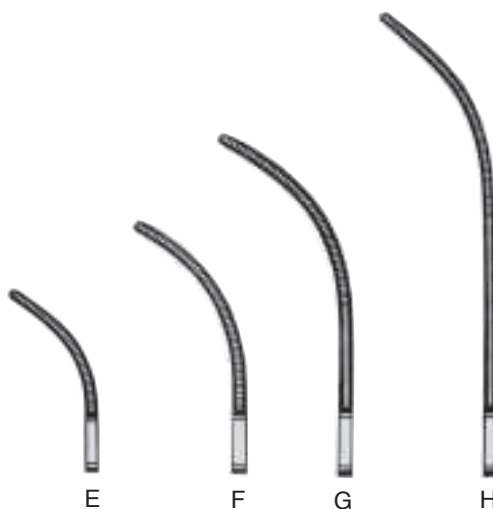

Artikel Item	Fig.	Gesamtlänge Overall length Longeur complet largo total Lunghezza total	Maullänge Jaw length longeur de mors largo de boca Lunghezza del morso	Gewicht Weight Poids Peso Peso
<b>41.0000</b>	A	60 mm	20 mm	5 g
<b>41.0001</b>	E	55 mm	20 mm	5 g
<b>41.0005</b>	B	70 mm	30 mm	9 g
<b>41.0006</b>	F	65 mm	30 mm	9 g
<b>41.0010</b>	C	90 mm	43 mm	12 g
<b>41.0011</b>	G	85 mm	43 mm	12 g
<b>41.0015</b>	D	105 mm	56 mm	14 g
<b>41.0016</b>	H	100 mm	56 mm	14 g
<b>41.0019</b>	J	55 mm	25 mm	7 g



**GREGORY**

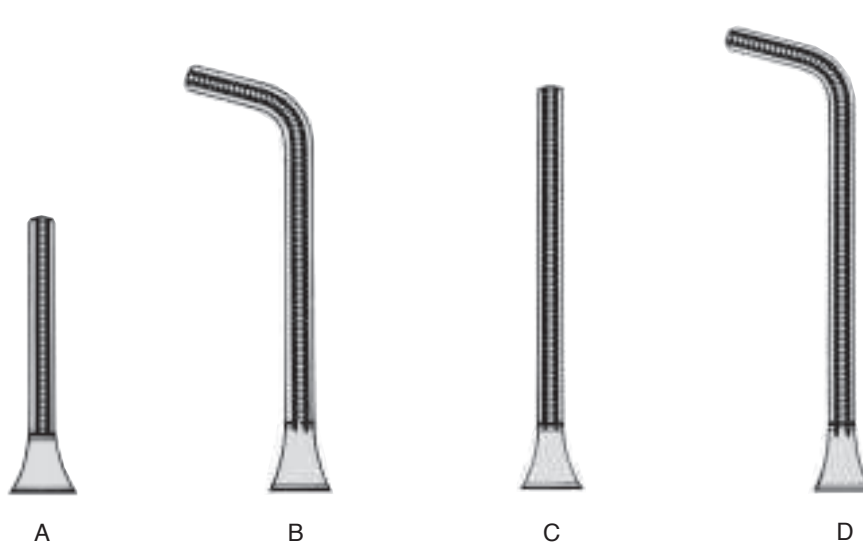

Artikel Item	Fig.	Gesamtlänge Overall length Longeur complet largo total Lunghezza total	Maullänge Jaw length longeur de mors largo de boca Lunghezza del morso	Gewicht Weight Poids Peso Peso
<b>41.0020</b>	A	90 mm	27 mm	11 g
<b>41.0021</b>	B	100 mm	44 mm	12 g
<b>41.0022</b>	C	110 mm	55 mm	12 g
<b>41.0023</b>	D	110 mm	60 mm	12 g



**GREGORY**

nach links gebogen  
 curved to left  
 courbe à gauche  
 curva a la izquierda  
 curvo a sinistra



A

nach rechts gebogen  
 curved to right  
 courbe à droit  
 curva a la derecha  
 curvo a destra



B

Artikel Item	Fig.	Gesamtlänge Overall length Longeur complet largo total Lunghezza total	Maullänge Jaw length longeur de mors largo de boca Lunghezza del morso	Gewicht Weight Poids Peso Peso
<b>41.0024</b>	A	110 mm	60 mm	12 g
<b>41.0025</b>	B	110 mm	60 mm	12 g



30 mm Maullänge  
 Jaw length  
 longueur de mors  
 largo de boca  
 Lunghezza del morso

**SANTULLI**  
**41.0028**  
 70 mm



A

B

C



D

E

F

G

**DIETRICH**

Artikel Item	Fig.	Gesamtlänge Overall length Longeur complet largo total Lunghezza total	Maullänge Jaw length longeur de mors largo de boca Lunghezza del morso	Gewicht Weight Poids Peso Peso	Schliesdruck Closing pressure Pression d'Occlusion Presión de cierre Pressione di chiusura
41.0030	A	50 mm	8 mm	3 g	80
41.0031	D	43 mm	8 mm	3 g	80
41.0032	B	53 mm	12 mm	3 g	80
41.0033	E	45 mm	12 mm	3 g	80
41.0034	C	60 mm	20 mm	3 g	80
41.0035	F	50 mm	20 mm	3 g	80
41.0037	G	54 mm	20 mm	3 g	80

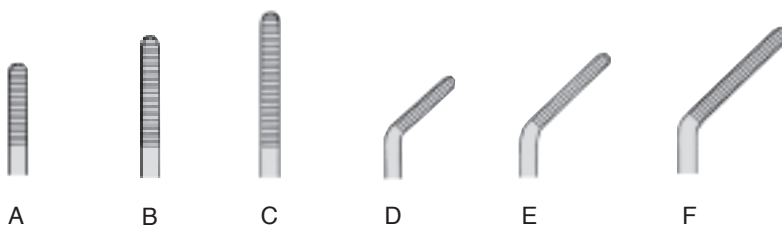

FEDERLEICHT • FEATHERLIGHT • POIDS PLUME • MUY LIGERO

Artikel Item	Fig.	Gesamtlänge Overall length Longeur complet largo total Lunghezza total	Maullänge Jaw length longeur de mors largo de boca Lunghezza del morso	Gewicht Weight Poids Peso Peso	Schliessdruck Closing pressure Pression d'Occlusion Presión de cierre Pressione di chiusura
41.0040	A	31 mm	10 mm	1 g	30
41.0041	B	35 mm	14 mm	1 g	30
41.0042	C	39 mm	18 mm	1 g	30
41.0043	D	30 mm	10 mm	1 g	30
41.0044	E	33 mm	14 mm	1 g	30
41.0045	F	36 mm	18 mm	1 g	30



WICKHAM

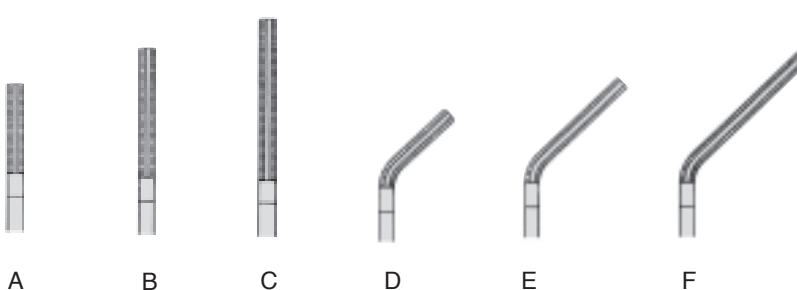

Artikel Item	Fig.	Gesamtlänge Overall length Longeur complet largo total Lunghezza total	Maullänge Jaw length longeur de mors largo de boca Lunghezza del morso	Gewicht Weight Poids Peso Peso	Schliessdruck Closing pressure Pression d'Occlusion Presión de cierre Pressione di chiusura
41.0080	A	49 mm	13 mm	3 g	150
41.0081	D	47 mm	13 mm	3 g	150
41.0082	B	54 mm	18 mm	3 g	150
41.0083	E	51 mm	18 mm	3 g	150
41.0084	C	61 mm	25 mm	3 g	150
41.0085	F	55 mm	25 mm	3 g	150

WICKHAM

41.0089 24 cm

Anlegezange / Applying forceps / Pince à pos / Pinza de aplicación / Pinza per metti-rimovi



**TITANIUM**

Identification:

**A = ARTERIA**

= closing force  
 220 - 240 ± 10 g

**V = VENA**

= closing force  
 110 - 130 ± 10 g

Anlege- u. Entfernungszange für  
 TITAN Miniatur-Bulldog-Clips

Applying- and removing Forceps for  
 TITAN Miniature Bulldog-Clips

Pinces pour poser et retirer les  
 TITAN Clips Bulldog

Pinza para poner y quitar TITAN  
 Miniature clips Bulldog

Pinza per metti-rimouvi TITAN  
 Clips Bulldog



3,0 cm

41.0050A  
 41.0050V



3,5 cm

41.0052A  
 41.0052V



4,0 cm

41.0054A  
 41.0054V



4,5 cm

41.0056A  
 41.0056V



3,0 cm

41.0051A  
 41.0051V



3,5 cm

41.0053A  
 41.0053V



4,0 cm

41.0055A  
 41.0055V



4,5 cm

41.0057A  
 41.0057V



41.0069  
 23 cm



3,0 cm

41.0061A  
 41.0061V



3,5 cm

41.0063A  
 41.0063V



4,0 cm

41.0065A  
 41.0065V



4,5 cm

41.0067A  
 41.0067V



**DEBAKEY-MICRO**

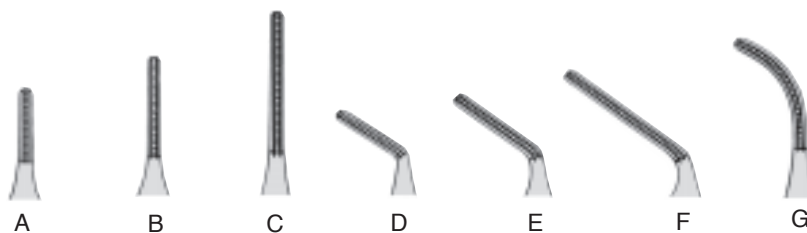

Artikel Item	Fig.	Gesamtlänge Overall length Longeur complet largo total Lunghezza total	Maullänge Jaw length longeur de mors largo de boca Lunghezza del morso	Gewicht Weight Poids Peso Peso	Schliessdruck Closing pressure Pression d'Occlusion Presión de cierre Pressione di chiusura
41.0090	A	47 mm	10 mm	3 g	180
41.0091	D	44 mm	10 mm	3 g	180
41.0092	B	51 mm	14 mm	3 g	180
41.0093	E	46 mm	14 mm	3 g	180
41.0094	C	57 mm	20 mm	3 g	180
41.0095	F	49 mm	20 mm	3 g	180
41.0099	G	54 mm	20 mm	3 g	180



**DEBAKEY**

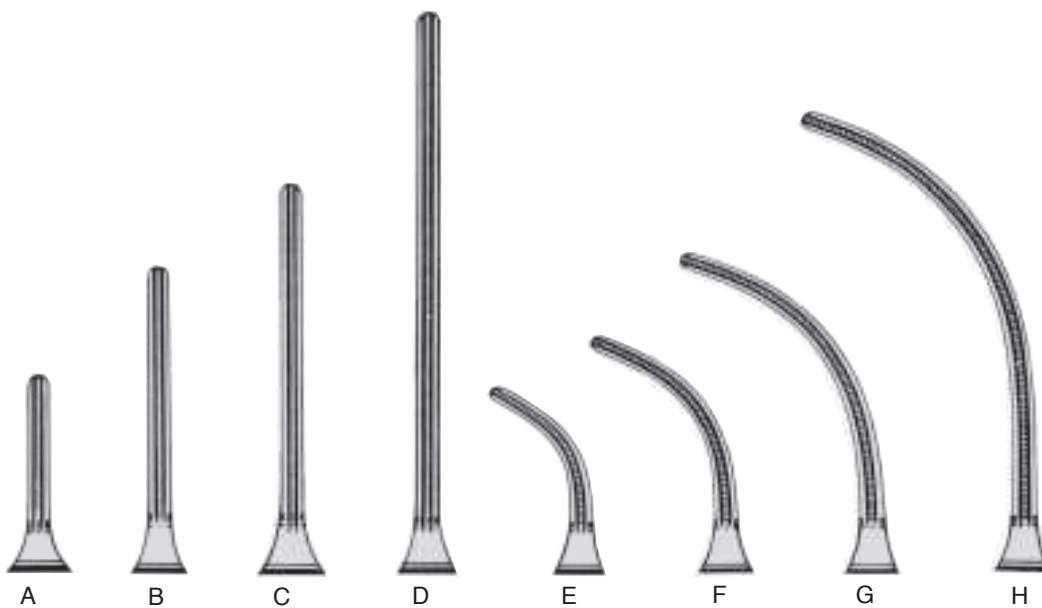

Artikel Item	Fig.	Gesamtlänge Overall length Longeur complet largo total Lunghezza total	Maullänge Jaw length longeur de mors largo de boca Lunghezza del morso	Gewicht Weight Poids Peso Peso
41.0100	A	80 mm	20 mm	10 g
41.0101	E	75 mm	20 mm	10 g
41.0110	B	90 mm	30 mm	11 g
41.0111	F	85 mm	30 mm	11 g
41.0115	C	105 mm	45 mm	12 g
41.0116	G	95 mm	45 mm	12 g
41.0120	D	125 mm	68 mm	12 g
41.0121	H	115 mm	68 mm	12 g



**DEBAKEY**  
**41.0130**  
12.5 cm



**DEBAKEY**  
**41.0132**  
12.5 cm



**DEBAKEY**  
**41.0134**  
12.5 cm 45°



**DEBAKEY**  
**41.0136**  
10 cm 90°



**DEBAKEY**  
**41.0138**  
12.5 cm



**DEBAKEY-SATINSKY**

41.0140 5,5 cm

41.0144 6,5 cm

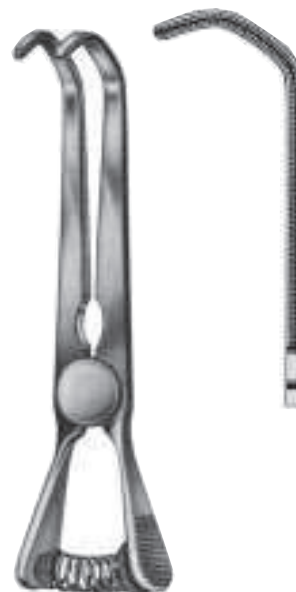

**DEBAKEY-SATINSKY**

41.0146 10 cm



**DEBAKEY-CAROTID**

41.0147 9 cm



**CARREL**  
15.0098 8,5 cm



15.0100

**HARTMANN**  
10 cm



**15.0108**  
glattes Maul  
smooth jaws  
lisses  
lisas  
liscio



**HARTMANN**  
15.0101 10 cm

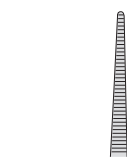

**HARTMANN-MICRO**  
15.0102 10 cm



**HARTMANN-MICRO**  
15.0103 10 cm



**HARTMANN**  
15.0104 10 cm 1x2



**HARTMANN**  
15.0105 10 cm 1x2

## TITANIUM



**JACOBSON-MICRO**  
15.0116 12,5 cm

15.0117

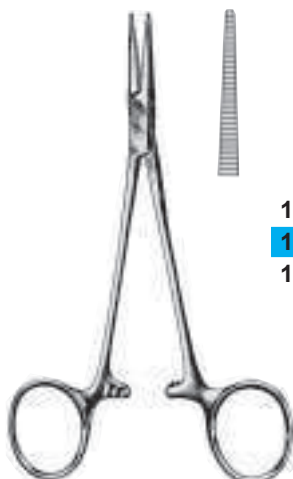

**MOSQUITO**  
15.0120 12,5 cm  
15.0120L 12,5 cm  
15.0120T 12,5 cm  
15.0124 14 cm

15.0121 12,5 cm  
15.0121T 12,5 cm  
15.0125 14 cm



15.0121L



**MICRO-MOSQUITO**  
15.0122 12,5 cm

15.0123



**MICRO-MOSQUITO**  
15.0128 12 cm 1x2

15.0129 1x2



**MOSQUITO**  
15.0126 12,5 cm 1x2  
15.0136 14 cm 1x2

15.0127 12,5 cm 1x2  
15.0137 14 cm 1x2



**MICRO-MOSQUITO**  
15.0139 12,5 cm  
kreuzgerieft / cross-serrated  
rainures croisées  
estriada en forma de cruz  
striatura cruciforme

**TITANIUM**

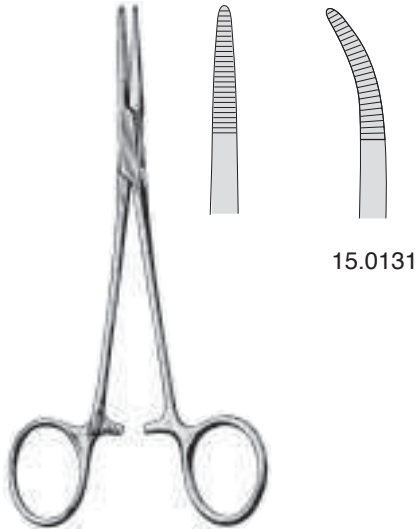

**PROVIDENCE-HOSPITAL**  
 15.0130 14,5 cm



**DUNHILL**  
 15.0180 12,5 cm



**KELLY**  
 15.0200 14 cm  
 15.0200T 14 cm



**CRILE**  
 15.0210 14 cm  
 15.0210T 14 cm



15.0211  
 15.0211T

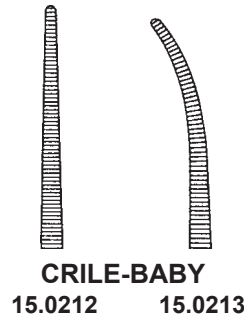

**CRILE-BABY**  
 15.0212 15.0213

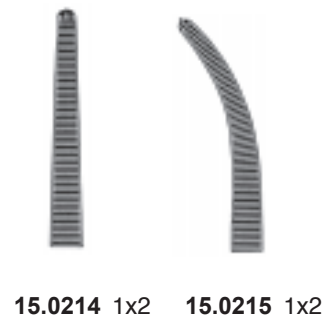

15.0214 1x2 15.0215 1x2



**DANDY-MOSQUITO**  
15.0218 12 cm



**DANDY**  
14,5 cm

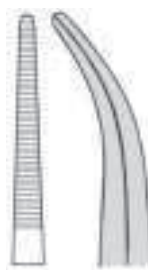

15.0220

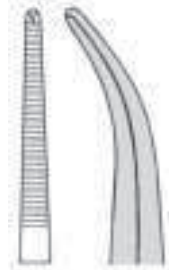

15.0222 1x2



**LOVELACE**  
15,5 cm



15.0224

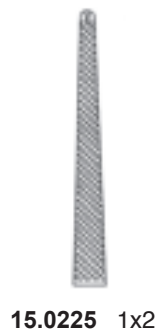

15.0225 1x2



**LERICHE**  
15 cm



15.0230



15.0231



15.0236 1x2



15.0237 1x2



15.0240

15.0241

**RANKIN-KELLY**  
16 cm



15.0251

**RANKIN-CRILE**  
15.0250 16 cm



15.0253  
1x2

**RANKIN-CRILE**  
15.0252 16 cm 1x2



**COLLER-CRILE**



15.0260  
14 cm



15.0262  
16 cm



15.0261  
14 cm



15.0263  
16 cm

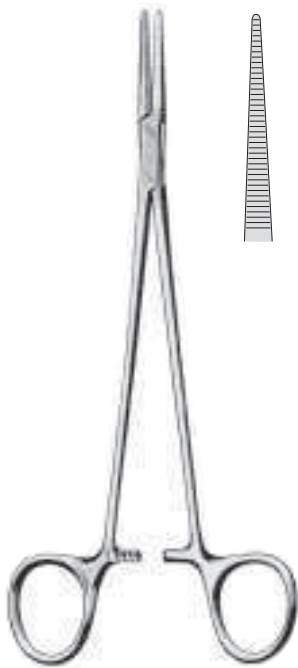

**HALSTED**

15.0300 18 cm

15.0302 21 cm

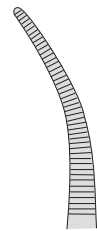

15.0301 18 cm

15.0303 21 cm



15.0306 18 cm 1x2

15.0308 21 cm 1x2

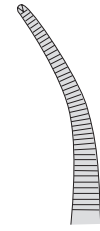

15.0307 18 cm 1x2

15.0309 21 cm 1x2



**ADSON-BABY**

15.0313 14 cm



15.0315

18 cm



**ADSON**

15.0310 18,5 cm

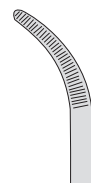

15.0311

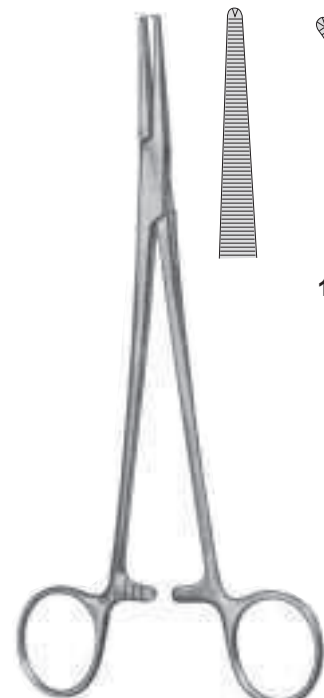

**ADSON**

15.0316 18,5 cm 1x2

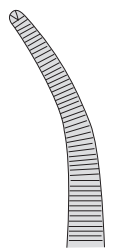

15.0317 1x2



**HEISS**  
 15.0320 20 cm



15.0321 15.0323 15.0324 15.0325  
 1x2 1x2



**FUCHSIG**  
 15.0331 18,5 cm



**NISSEN**  
 15.0335 19 cm

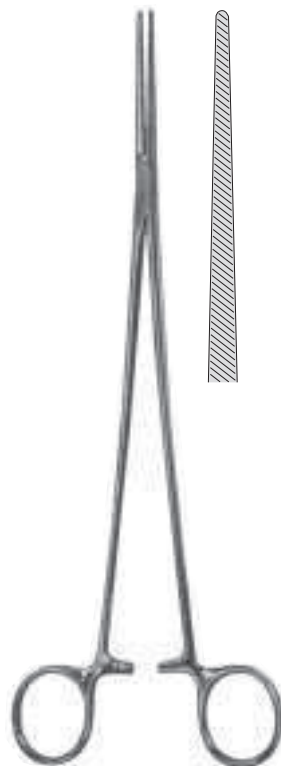

**BENGOLEA**  
 15.0360 20 cm  
 15.0362 26 cm

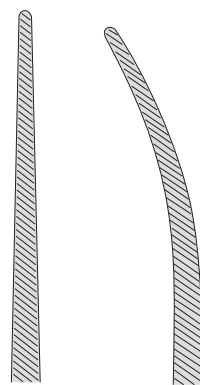

15.0361 20 cm  
 15.0363 26 cm

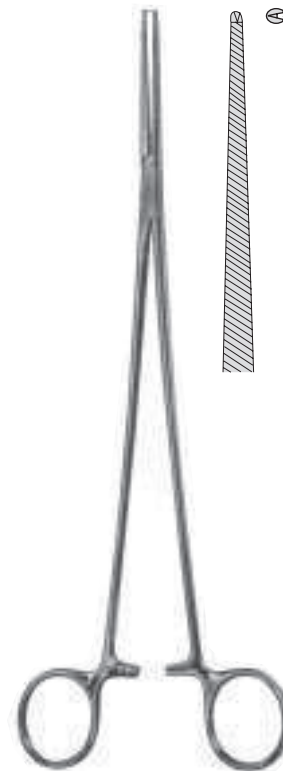

**BENGOLEA**  
 15.0364 20 cm 1x2  
 15.0366 26 cm 1x2

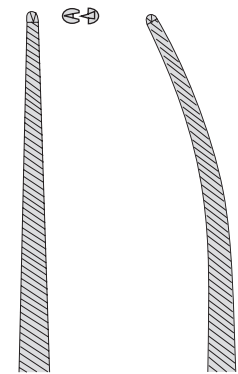

15.0365 20 cm 1x2  
 15.0367 26 cm 1x2



**BRIDGE**  
15.0392 28 cm



15.0393  
28 cm

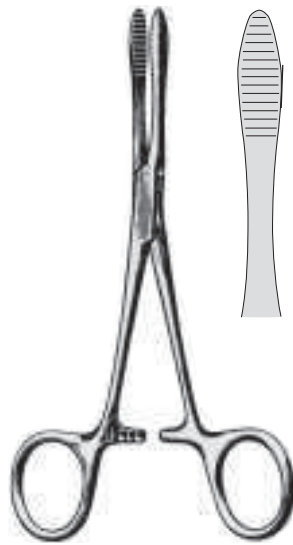

**PEAN**  
15.0404 12,5 cm  
15.0406 14,5 cm  
15.0408 16 cm



**SPENCER-WELLS**  
15.0410 13 cm  
15.0412 14 cm  
15.0414 15 cm  
15.0416 18 cm  
15.0418 20 cm

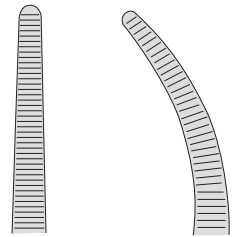

**SPENCER-WELLS**  
15.0411 13 cm  
15.0413 14 cm  
15.0415 15 cm  
15.0417 18 cm  
15.0419 20 cm



**ROCH-CARMALT**  
15.0430 16 cm  
15.0432 20 cm

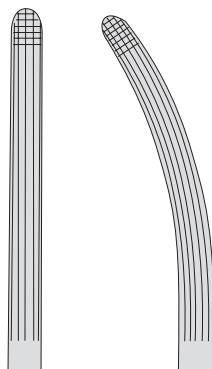

15.0431 16 cm  
15.0433 20 cm



**BAINBRIDGE**  
15.1320 15,5 cm  
15.1322 18,0 cm

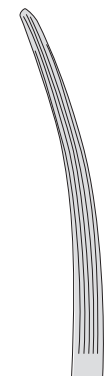

15.1321 15,5 cm  
15.1323 18,0 cm

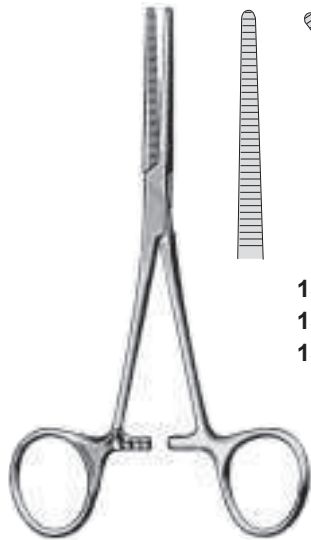

**15.0451** 13 cm  
**15.0453** 14 cm  
**15.0455** 16 cm

**PEAN-FINO**

**15.0450** 13 cm  
**15.0452** 14 cm  
**15.0454** 16 cm



**15.0459** 13 cm  
**15.0461** 14 cm  
**15.0463** 16 cm  
**15.0465** 18 cm  
**15.0467** 20 cm  
**15.0469** 22 cm  
**15.0471** 24 cm  
**15.0473** 26 cm  
**15.0477** 30 cm

**ROCHESTER-PEAN**

**15.0458** 13 cm  
**15.0460** 14 cm  
**15.0462** 16 cm  
**15.0464** 18 cm  
**15.0466** 20 cm  
**15.0468** 22 cm  
**15.0470** 24 cm  
**15.0472** 26 cm  
**15.0476** 30 cm



**15.0481**

**ROBERTS**

**15.0480** 22 cm



**OLIVECRONA**

**15.0482**  
18 cm

**15.0484**  
20 cm

**15.0486**  
24 cm



**CRAFOORD**

**15.0492**  
18 cm

**15.0493**  
20 cm

**15.0494**  
24 cm



**CRAFOORD-SELLORS**  
24 cm

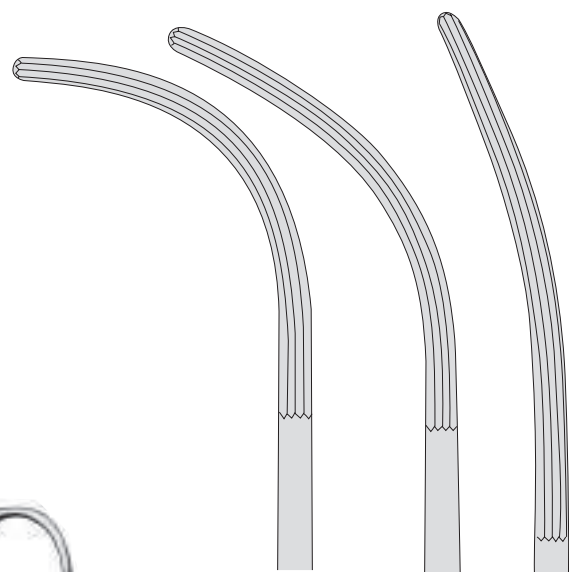

**15.0495**

**15.0496**

**15.0497**



**SAROT**  
 15.0500 24 cm



15.0501



**ZENKER**  
 15.0521 29,5 cm



15.0523



**KELLY**

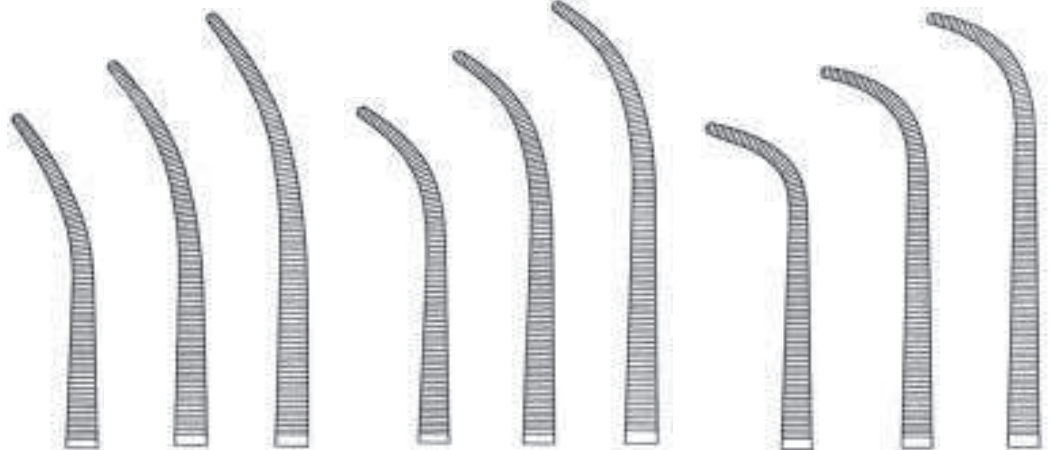

15.0531	15.0532	15.0533	15.0534	15.0535	15.0536	15.0537	15.0538	15.0539
19 cm	22 cm	24 cm	19 cm	22 cm	24 cm	19 cm	22 cm	24 cm

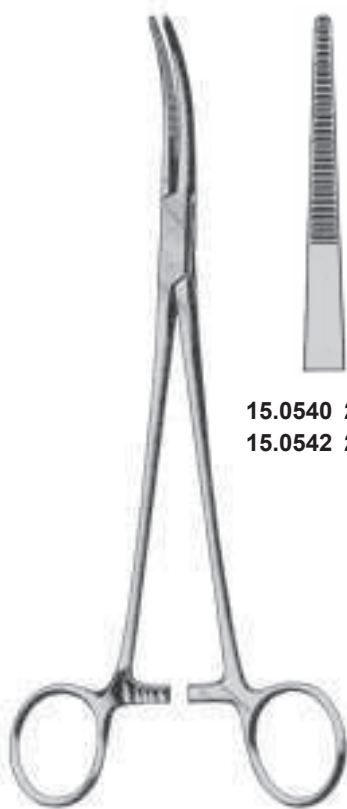

**15.0540** 21 cm  
**15.0542** 26 cm



**15.0541** 21 cm  
**15.0543** 26 cm



**15.0546** 21 cm 1x2  
**15.0547** 26 cm 1x2



**15.0548** 21 cm 1x2  
**15.0549** 26 cm 1x2

**TOENNIS**

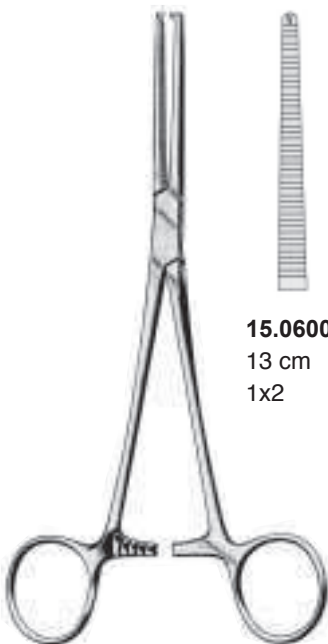

**15.0600**  
13 cm  
1x2



**15.0601**  
13 cm  
1x2



**15.0602**  
14,5 cm  
1x2



**15.0603**  
14,5 cm  
1x2



**15.0604**  
16 cm  
1x2



**15.0605**  
16 cm  
1x2



**15.0607** 14 cm  
**15.0609** 16 cm

**KOCHER**

**KOCHER-FINO**

**15.0606** 14 cm  
**15.0608** 16 cm



**ROCHESTER-OCHSNER**

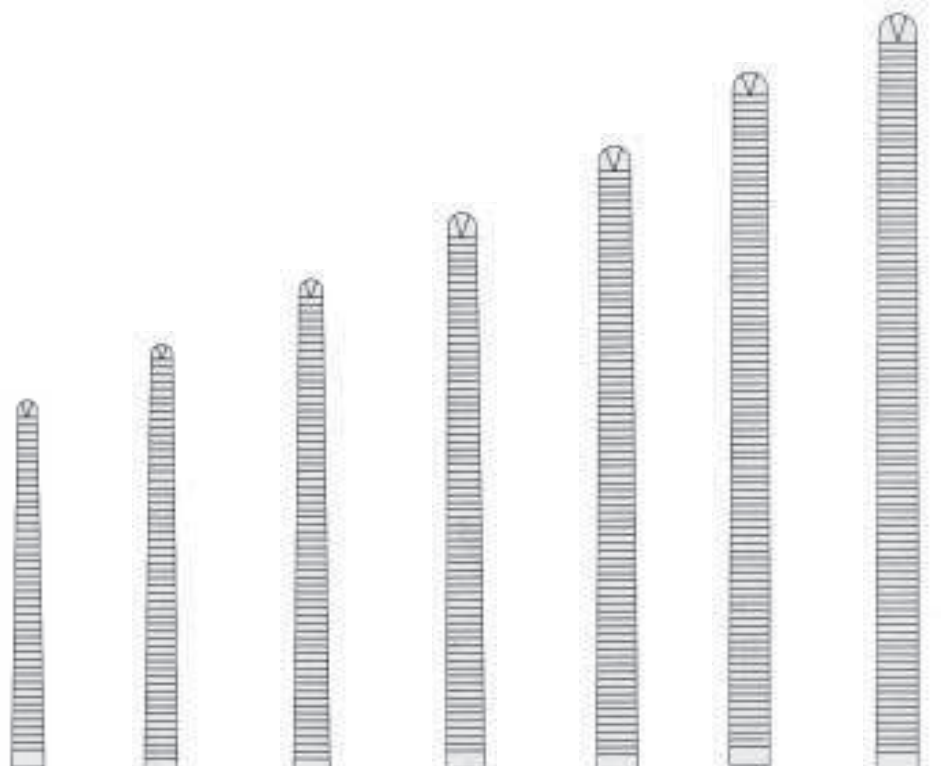

<b>15.0620</b>	<b>15.0622</b>	<b>15.0624</b>	<b>15.0626</b>	<b>15.0628</b>	<b>15.0630</b>	<b>15.0632</b>
16 cm	18 cm	20 cm	22 cm	24 cm	26 cm	30 cm
1x2	1x2	1x2	1x2	1x2	1x2	1x2

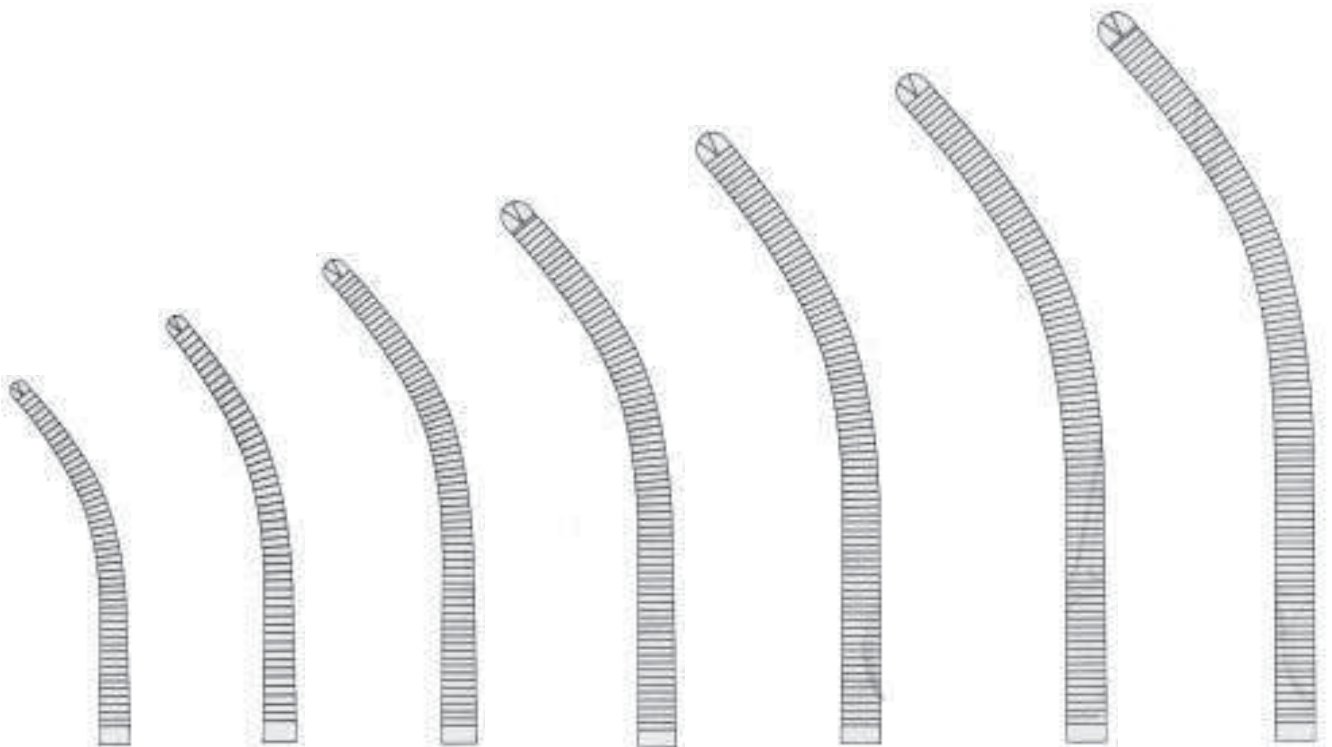

<b>15.0621</b>	<b>15.0623</b>	<b>15.0625</b>	<b>15.0627</b>	<b>15.0629</b>	<b>15.0631</b>	<b>15.0633</b>
16 cm	18 cm	20 cm	22 cm	24 cm	26 cm	30 cm
1x2	1x2	1x2	1x2	1x2	1x2	1x2



**MIXTER-O'SHAUGHNESSY**

15.0701 15 cm

15.0703 19 cm



**OVERHOLT-BABY**

15.0720 14 cm

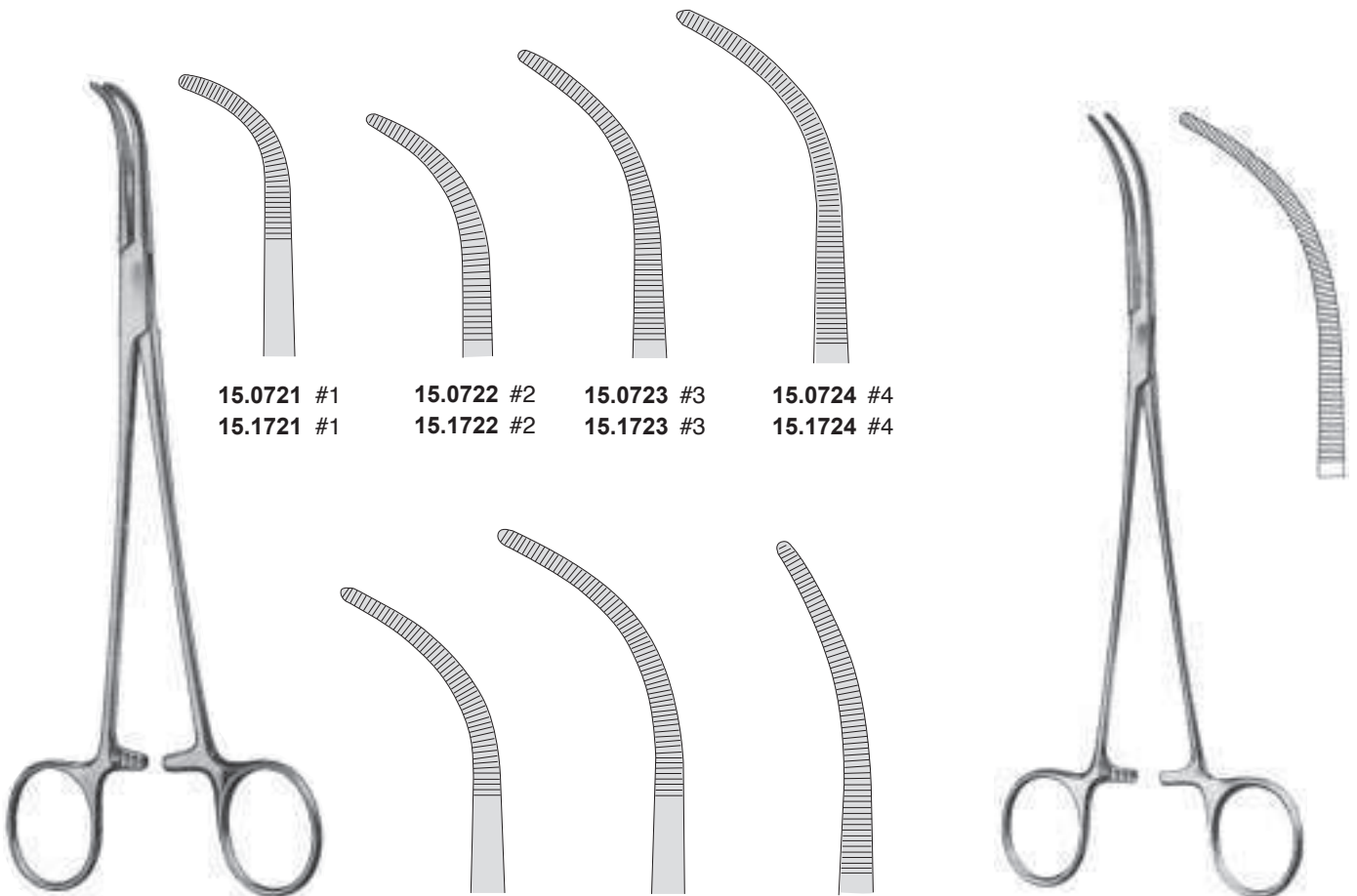

15.0721 #1

15.1721 #1

15.0722 #2

15.1722 #2

15.0723 #3

15.1723 #3

15.0724 #4

15.1724 #4

**OVERHOLT-GEISSENDOERFER**

15.0721-15.0727 21 cm

15.1721-15.1727 27 cm

15.0725 #5

15.1725 #5

15.0726 #6

15.1726 #6

15.0727 #7

15.1727 #7

**OVERHOLT-MIXTER**

15.0729 21 cm

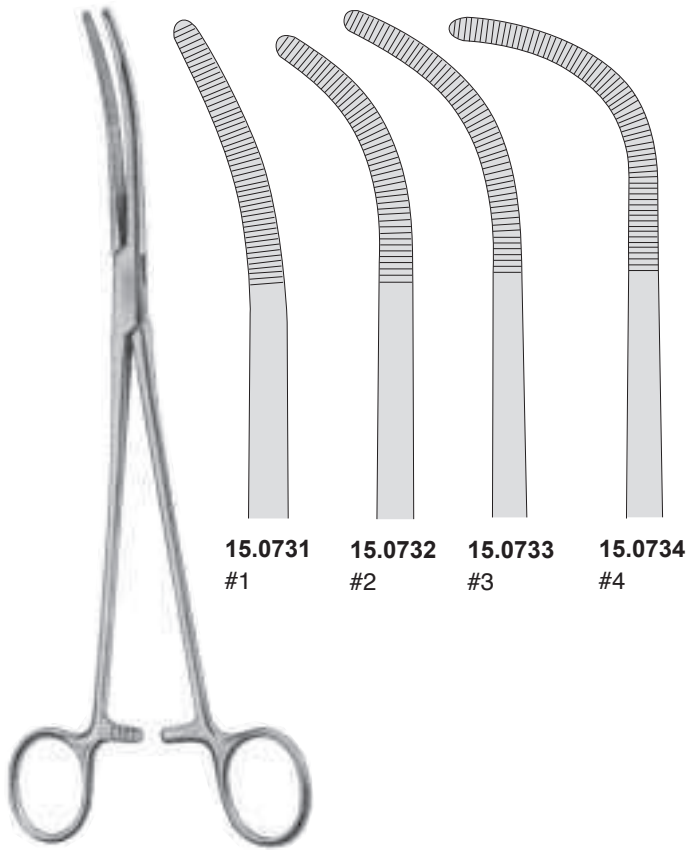

**RUMEL**  
23 cm



**KANTROWITZ**



**GEMINI-MINI**

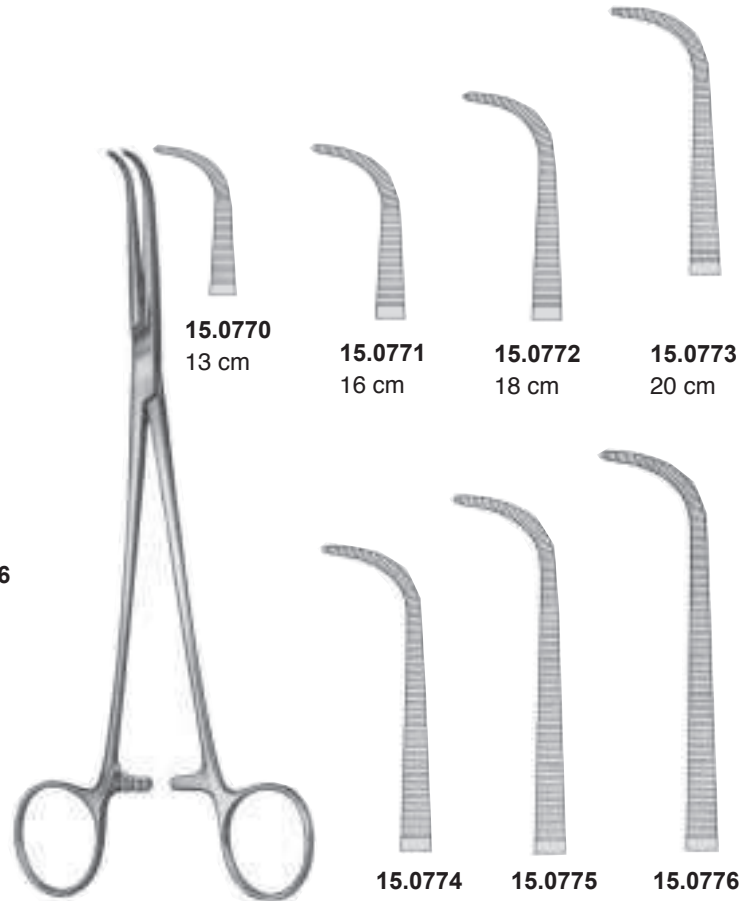

**GEMINI**



**WIKSTROEM**  
15.0780 21 cm  
15.0782 24 cm



**LAWRENCE**  
15.0784 28 cm



**MEEKER**  
15.0786 28 cm



**MIXTER-BABY**  
15.0801 14,5 cm



**MIXTER-BABY**  
15.0803 18 cm



**MIXTER**  
 15.0807 22 cm



**MIXTER**  
 15.0809 23 cm



**MIXTER**

**15.0811**  
 16 cm

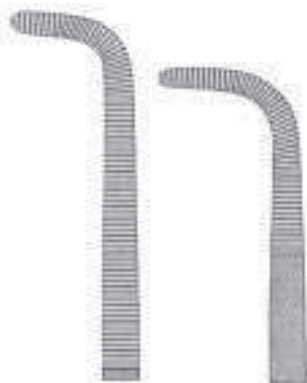

**15.0813**  
 19 cm



**15.0817**  
 23 cm



**MIXTER**

**15.0831**  
 22 cm

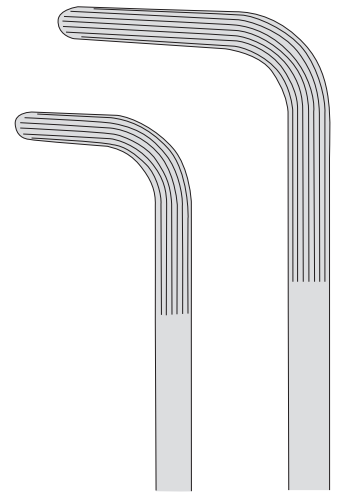

**15.0833**  
 25 cm

**15.0835**  
 28 cm



**SCHNIDT**  
34.0303  
19 cm



**SAWTELL**  
34.0305  
19 cm



**SCHNIDT**  
34.0307  
19 cm



**SAWTELL**  
34.0309  
19 cm



**NEGUS**  
19 cm



34.0311



34.0313



**WHITE**  
34.0321 18 cm  
34.0323 23 cm



**34.0330**  
18,5 cm

**BIRKETT**



**34.0331**  
18,5 cm



**BALLENGER**  
**34.0333**  
21,5 cm



**BLOHMKE**  
**34.0335**  
20 cm



**MARSHIK**  
**34.0350**  
22 cm



**COLVER**  
19 cm



**34.0327**



**34.0329**



**HARRINGTON**  
 40.0701  
 30,5 cm



**HARRINGTON**  
 40.0702  
 29,5 cm



**40.0713**  
 Zähne links  
 teeth on left  
 dents à gauche  
 dientes a la izquierda  
 denti sinistro



**SAROT**  
 23 cm



**40.0714**  
 Zähne rechts  
 teeth on right  
 dents à droite  
 dientes a la derecha  
 denti destro



**FINOCCHIETTO**  
 40.0720  
 24 cm



40.0730

**PRICE-THOMAS**

22 cm



**40.0731**

Zähne links  
teeth on left  
dents à gauche  
dientes a la izquierda  
denti sinistro

**PRICE-THOMAS**

22 cm



**40.0732**

Zähne rechts  
teeth on right  
dents à droite  
dientes a la derecha  
denti destro



**BRONCHUS**

23 cm



**40.0740**

60 mm



**40.0742**

80 mm



**LOVELACE**  
40.0750  
20 cm



**LOVELACE**  
40.0751  
20 cm



**SEMB**



**40.0761**  
24 cm #1



**40.0763**  
24 cm #2



**SATINSKY**  
**40.0900**  
15 cm

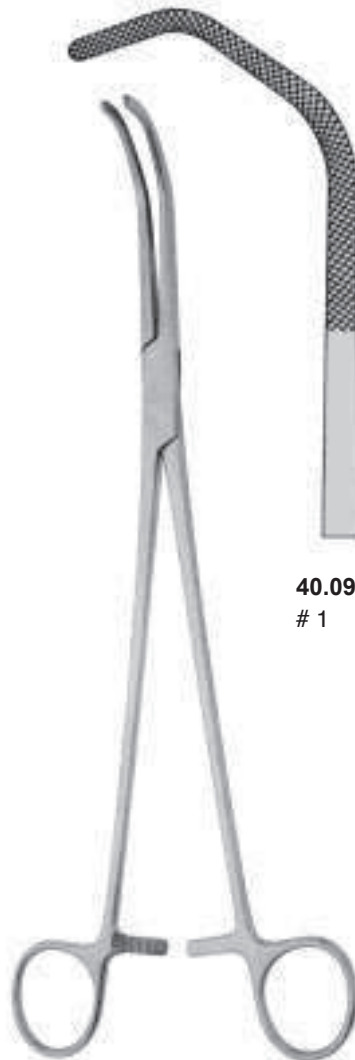

**40.0902**  
# 1



**40.0904**  
# 2

**SATINSKY**  
26 cm



**CHAPUT**  
 15.1200 12 cm



**TUFFIER**  
 15.1204 13 cm

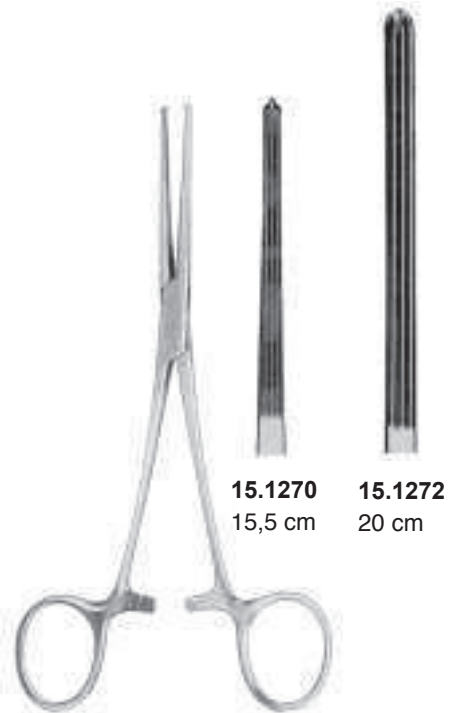

**15.1270** 15,5 cm  
**15.1272** 20 cm

**ALLEN-KOCHER**



**PENNINGTON**  
 15.1300 15 cm  
 15.1302 20 cm



**ALLIS-BABY**  
 48.0004 13 cm, 4 x 5  
 48.0006 14 cm, 4 x 5



**48.0010**  
 15 cm, 4 x 5

**48.0011**  
 15 cm, 5 x 6

**48.0014**  
 19 cm, 5 x 6

**48.0016**  
 25 cm, 5 x 6

**ALLIS**

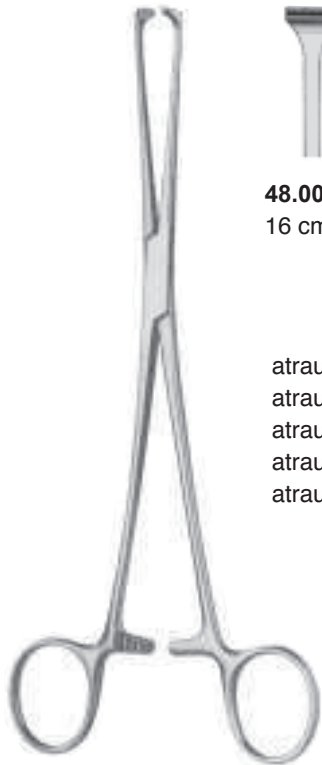

**ALLIS**

**48.0020**  
16 cm

atraumatisch  
 atraumatic  
 atraumatique  
 atraumática  
 atraumatiche

**48.0024**  
20 cm

**48.0028**  
25 cm

**48.0029**  
30 cm



**ALLIS-ADAIR**  
48.0030 15,5 cm



**JUDD-ALLIS**  
48.0032 15 cm  
48.0034 19 cm  
3 x 4



**LITTLEWOOD**  
48.0035 19 cm  
2 x 3



**BOYS-ALLIS**  
48.0036 15 cm



**THOMS-ALLIS**  
48.0038 20 cm  
6 x 7



**LOCKWOOD**  
48.0040 19,5 cm



**OMBREDANNE**  
48.0050 13,5 cm



**WILLIAMS**  
48.0045 16,5 cm



**BABCOCK**



48.0062  
16 cm



48.0064  
18 cm



48.0066  
20 cm



48.0068  
24 cm



**BABCOCK**



**48.0072**  
16 cm



**48.0076**  
20 cm



**BABCOCK-DEBAKEY**



**48.0082**  
16 cm



**48.0086**  
20 cm



**48.0088**  
23 cm



**COLLIN**  
**48.0089**  
 14 cm



**DUVAL**



**48.0090**  
 18 cm / 14 mm  
**48.0092**  
 20 cm / 14 mm



**48.0094**  
 20 cm / 25 mm  
**48.0098**  
 23 cm / 25 mm



**48.0094 AT**  
 20 cm / 20 mm  
**48.0098 AT**  
 23 cm / 25 mm

atraumatisch  
 atraumatic  
 atraumatique  
 atraumática  
 atraumatiche



**DUVAL**



**48.0099**  
 20 cm / 15 mm





**15.1580**  
25 cm

**15.1582**  
27 cm

**DEBAKEY**



**PRATT**  
**15.1350** 15 cm



**KOCHER-BABY**  
13 cm

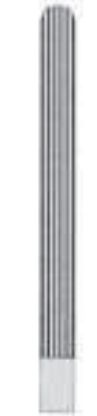

48.0100



48.0101

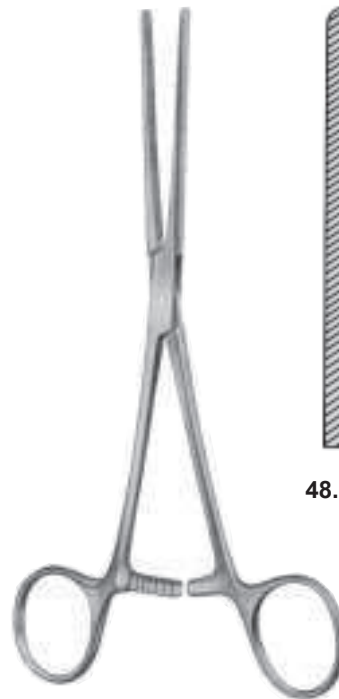

**DOYEN**  
18 cm



48.0102



48.0103



**DOYEN**



48.0104 21 cm  
48.0106 23 cm

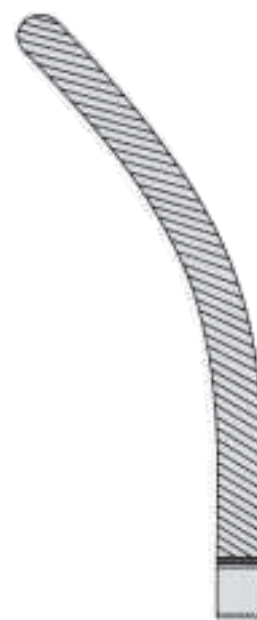

48.0105 21 cm  
48.0107 23 cm



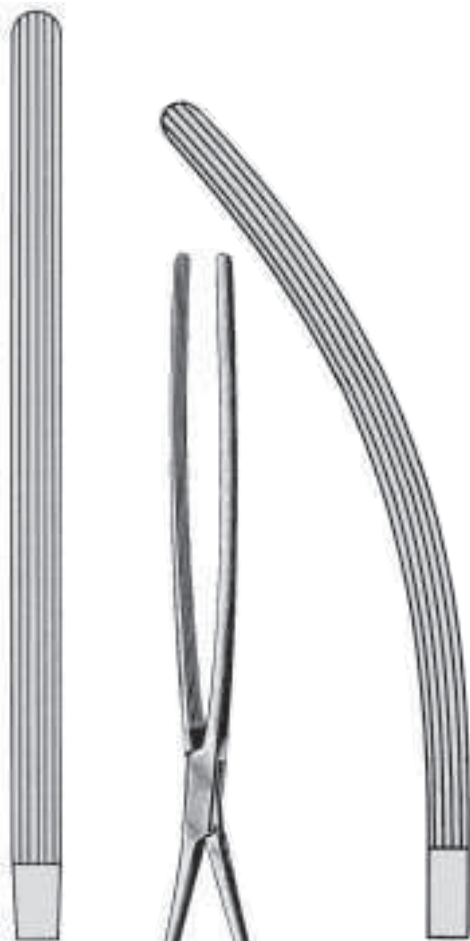

48.0118  
25 cm

48.0119  
25 cm

MAYO-ROBSON

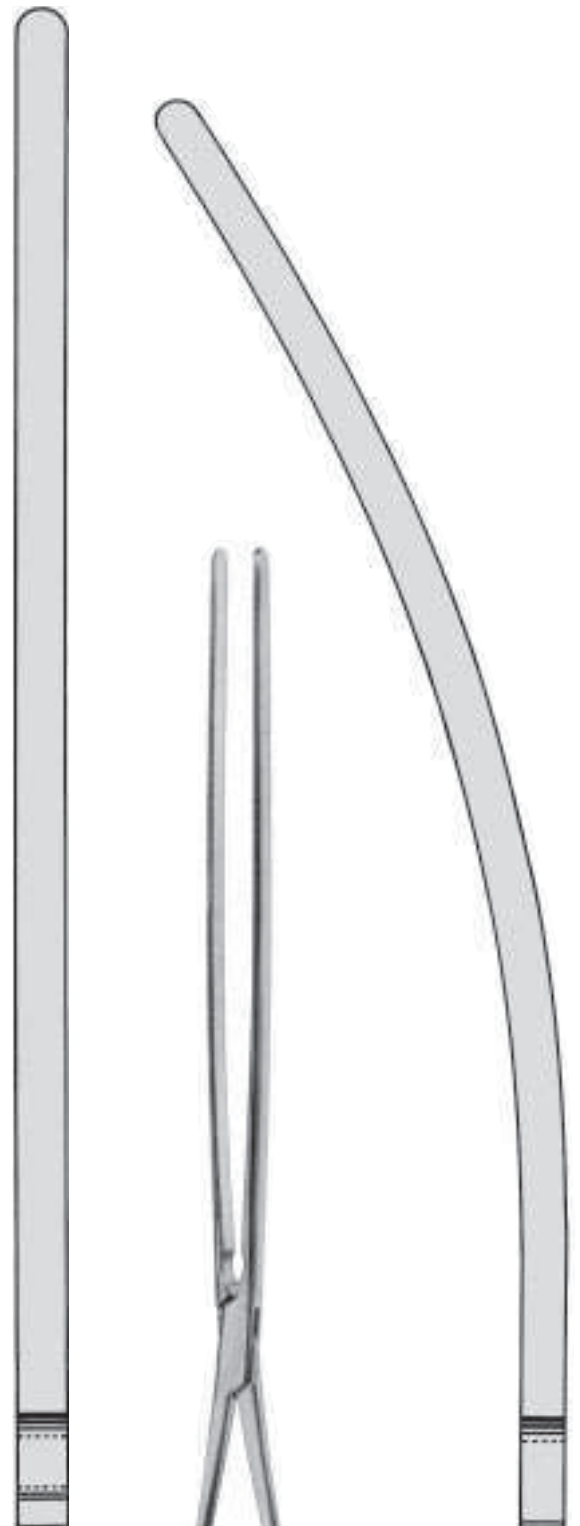

48.0120  
33 cm

48.0121  
33 cm

SCUDDER



**NUSSBAUM**  
25 cm

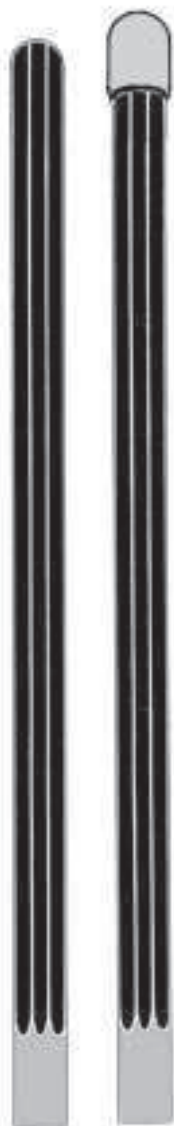

48.0122



48.0123



**BRUNNER**  
48.0125 23 cm



**48.0130**  
26,5 cm / 30 mm



**48.0131**  
26,5 cm / 60 mm



**48.0132**  
26,5 cm / 75 mm



**FEHLAND**  
48.0126 24 cm



**BEST**



**LANE**  
48.0140 30 cm

**LANE**  
48.0141 30 cm



48.0150 13 cm  
 48.0152 16 cm

DOYEN-DEBAKEY



48.0151 13 cm  
 48.0153 16 cm

DOYEN-DEBAKEY



48.0154 18 cm  
 48.0156 21 cm  
 48.0158 23 cm

DOYEN-DEBAKEY



48.0155 18 cm  
 48.0157 21 cm  
 48.0159 23 cm

DOYEN-DEBAKEY



**KOCHER-DEBAKEY**

**48.0160** 22 cm

**48.0162** 25 cm

**48.0164** 28 cm



**KOCHER-DEBAKEY**

**48.0161** 22 cm

**48.0163** 25 cm

**48.0165** 28 cm



**HAYES-DEBAKEY**



**48.0170**  
26 cm / 55 mm

**48.0172**  
28 cm / 85 mm



**FEHLAND-DEBAKEY**  
48.0180 24 cm



**KERSTING**  
48.0184  
31 cm



**RESANO**  
48.0186  
30 cm



**SCUDDER-DEBAKEY**  
48.0190  
33 cm



**SCUDDER-DEBAKEY**  
48.0191  
33 cm



**48.0200**  
25 cm 0°



**48.0204**  
28 cm 0°

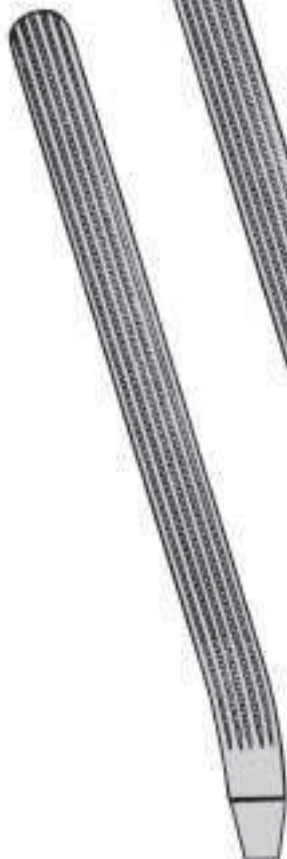

**48.0201**  
25 cm 15°



**48.0205**  
28 cm 15°

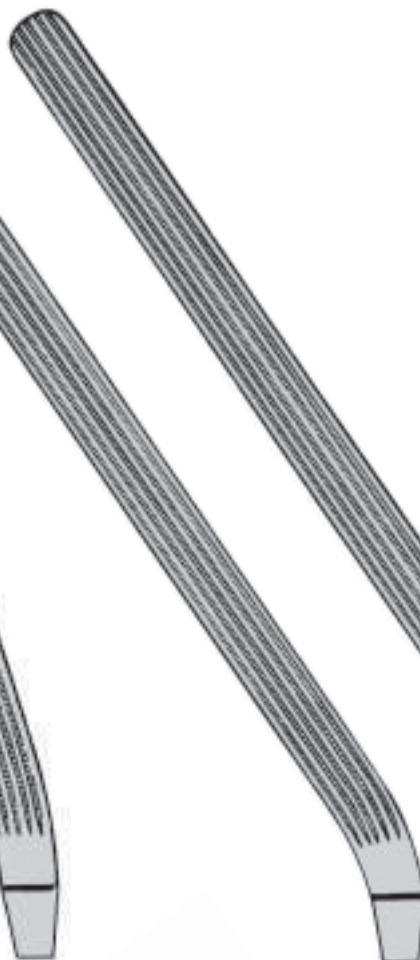

**48.0203**  
25 cm 30°

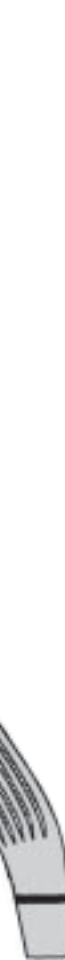

**48.0207**  
28 cm 30°



**MARINUS**



**BUIE**  
 48.0300 21 cm



**LLOYD-DAVIES**  
 48.0350 31,5 cm



**FERGUSSON**

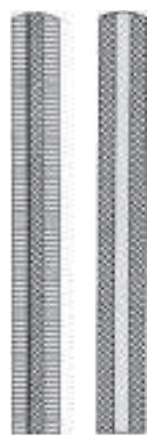

48.0312 20 cm

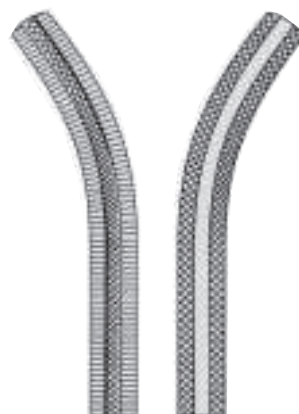

48.0313 20 cm

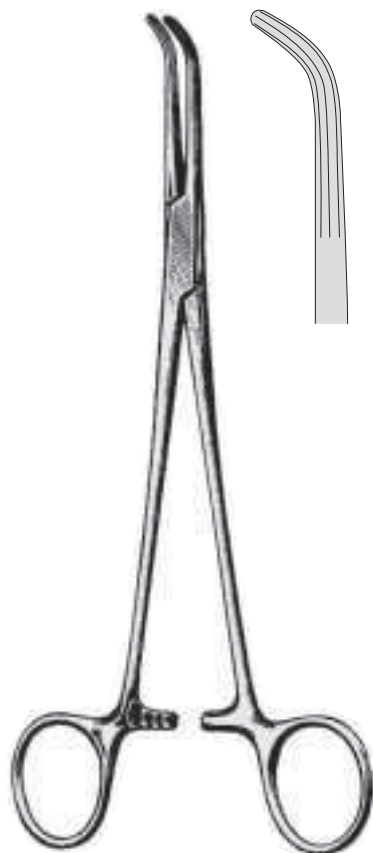

**LAHEY**

**15.0841** 19 cm

**15.0843** 23 cm



**MOYNIHAN**

**15.0901** 23 cm

**15.0903** 24 cm



**DESJARDIN**

**15.0911** 21 cm



**DESJARDIN**

**15.0913** 21 cm



**LOWER**  
15.0931 18 cm



**JOHNS-HOPKINS**  
15.0941 20 cm



**MIXTER**  
15.1015 22 cm



**GRAY**  
15.1031 22 cm #1



**15.1033**  
23 cm #2



**GRAY**  
15.1035 22 cm #1



**15.1037**  
23 cm #2



**BLAKE**  
20 cm

50.0300



50.0301



**DESJARDINS**  
23 cm



50.0311  
#1



50.0313  
#2



**DESJARDINS**



50.0315  
24 cm



50.0317  
22,5 cm



**MAYO-BLAKE**  
50.0320  
20 cm



**MAYO-BLAKE**  
50.0321  
20 cm



**MIXTER**  
50.0325  
22 cm



**DOYEN**  
50.0330  
20 cm



**MAYO-GUYON**  
15.1930 23 cm



**GUYON**

**15.1931**  
20 cm



**15.1933**  
22 cm



**15.1935**  
24 cm



**GUYON**  
15.1937 23 cm



**STILLE**  
15.1940 23 cm



**HERRICK**  
15.1960 23 cm



**50.0340**  
 23 cm #1



**50.0342**  
 21 cm #2



**50.0344**  
 19 cm #3



**50.0346**  
 18 cm #4



**50.0348**  
 19 cm #5



**50.0350**  
 19 cm #6

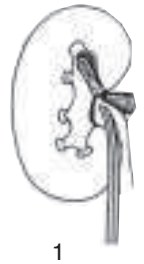

1



2

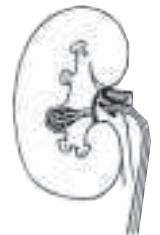

3



4



5 / 6

## RANDALL

**50.0347**

Satz #1-4 / Set #1-4 /

Jeu #1-4 / Juego #1-4 / Serie di #1-4



**RANDALL**



**URO**

24 cm

Ureterzangen  
Ureter Forceps  
Pincés pour urètre  
Pinzas para uréter  
Pinze per uretere



**50.0401**  
# 1



**50.0402**  
# 2



**DARTIGUES**

**55.1520**

27 cm

Nierenfaßzange  
Kidney elevating forceps  
Hystérolabe  
Pinza para sostener el riñón  
Pinze per afferare il rene

Prostata-Fasszange  
Prostatic grasping forceps  
Pince à saisir la prostate  
Pinza para coger prostata  
Pinza per afferare la prostata



**YOUNG**  
**51.0004**  
20 cm

Samenstrang-Fixierklemme  
Spermatic cord fixation clamp  
Pince pour fixer le canal déférent  
Pinza-fixajion canal espermatica  
Pinza per fissare il tronco spermatico

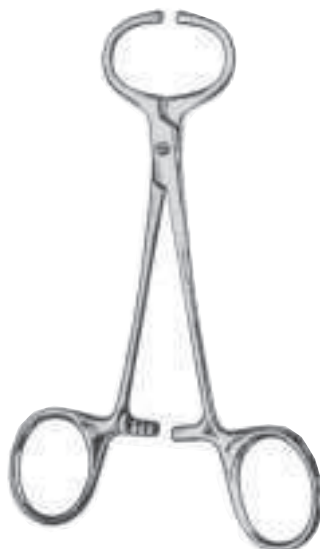

**SPERMATIC**  
**51.0040**  
14,5 cm

Ureterklemmen  
Ureter clamps  
Pinces à urètere  
Pinzas clamps para ureter  
Pinze per uretere

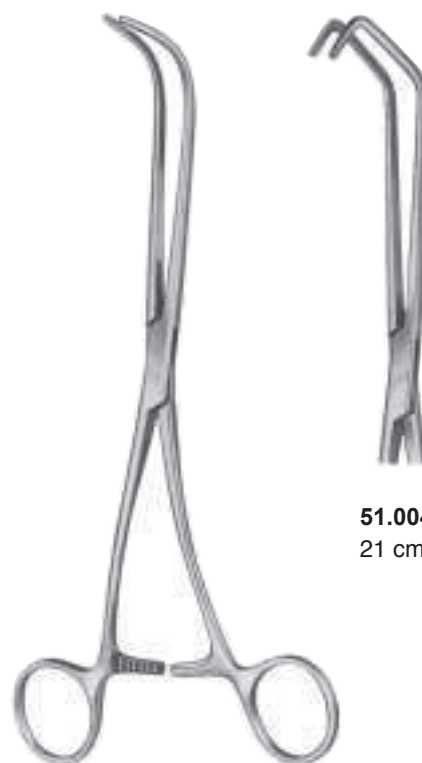

**51.0042**  
21 cm #2

**LURZ**  
**51.0041**  
21 cm #1



**WERTHEIM**  
 15.2125  
 24 cm 1x2



**15.2200**  
 18 cm

**15.2202**  
 20 cm

**MIKULICZ**



**15.2209**  
 20 cm

**15.2211**  
 20 cm

**MIKULICZ**



**MIKULICZ-BABY**  
 15.2215 14 cm



**15.2221**

**15.2223**

**FAURE**  
 20 cm



**FAURE**  
 15.2225 25 cm



**PHANEUF**

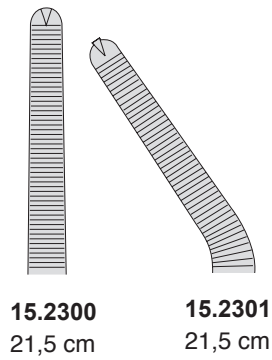

**15.2300**  
21,5 cm

**15.2301**  
21,5 cm

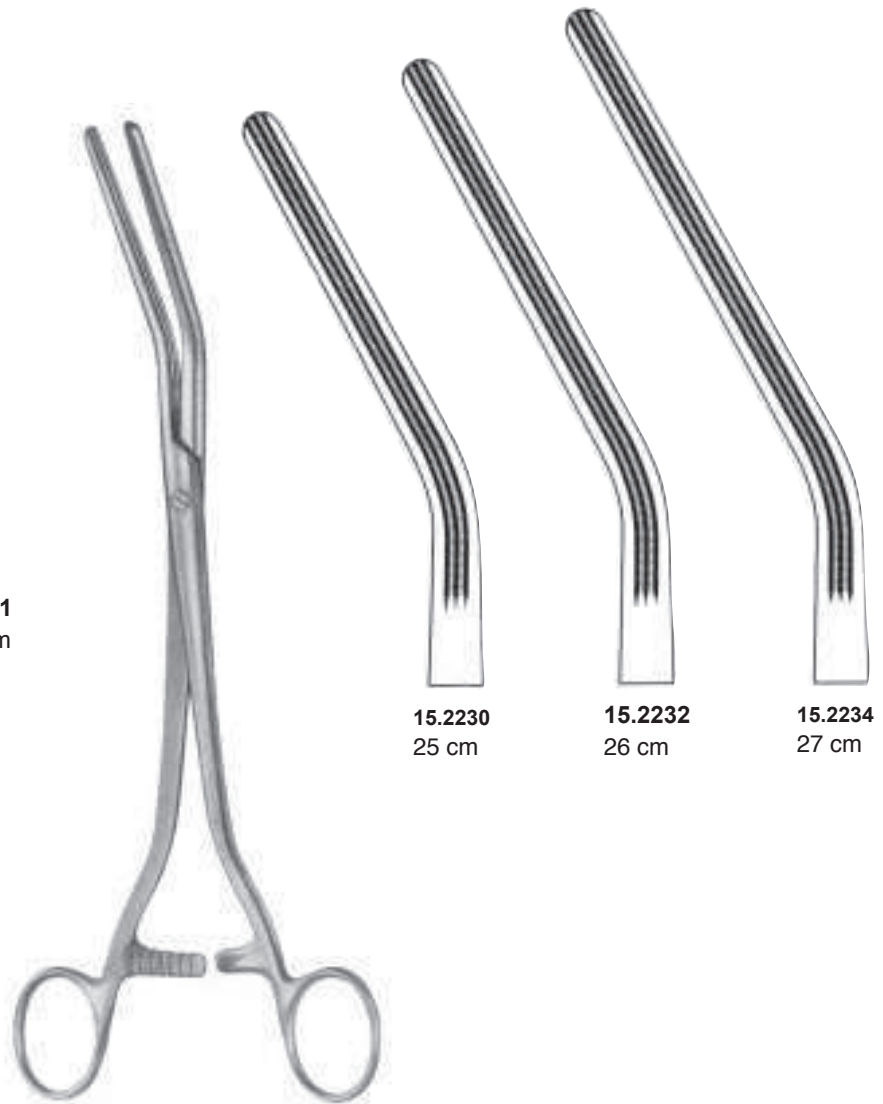

**DICK**

Druckklemmen  
Pressure Clamps  
Pinces à pression  
Pinzas de presión  
Pinze de pressione

**15.2230**  
25 cm

**15.2232**  
26 cm

**15.2234**  
27 cm



**HEANEY-KANTOR**

15.2311 20 cm  
15.2313 23 cm



**HEANEY-REZEK**

15.2314 23 cm



**HEANEY**

15.2315 20 cm  
15.2317 23 cm



**WERTHEIM**

15.2321 25 cm



**SEOND-  
LANDAU**

15.2324  
24 cm



**SEOND**

15.2325  
24 cm



**WERTHEIM-CULLEN**  
15.2340 21,5 cm



**WERTHEIM-ATRAUMA**  
15.2344 21 cm

atraumatisch  
atraumatic  
atraumatique  
atraumática  
atraumatiche



**15.2345**  
22 cm  
1x2

**15.2347**  
22 cm  
1x2



**15.2348**  
22 cm  
1x2

**15.2349**  
22 cm  
1x2

**WERTHEIM**

**WERTHEIM**



**15.2360**  
22 cm



**15.2361**  
22 cm



**15.2362**  
21 cm



**15.2363**  
20 cm



**WERTHEIM-DEBAKEY**



**15.2365**  
25 cm



**15.2366**  
25 cm



**15.2367**  
25 cm



**15.2368**  
24 cm

HAKENZANGEN

TENACULUM FORCEPS

PINCES POUR ABAISSEMENT DU COL UTERIN

PINZAS PARA COGER EL CUELLO DEL UTERO

PINZE PER ABBASSARE EL COLLO DELL'UTERO

**PRO-MED**



**BARRETT**  
55.0930  
18 cm



**STAUDE-MOORE**  
55.0932  
17 cm



**BRAUN**  
55.0934  
25 cm



**CZERNY**  
55.0936  
21 cm



**ADAIR**  
**55.0938**  
19 cm



**SCHROEDER**  
**55.0940**  
25 cm



**POZZI**  
**55.0944**  
25 cm



**DUPLAY**  
55.0947  
28 cm



**HULKA**  
55.0948  
29 cm



**HULKA-KENWICK**  
55.0949  
29 cm



**SKENE**  
55.0951  
24 cm



**TIEMANN**  
55.0956  
22 cm

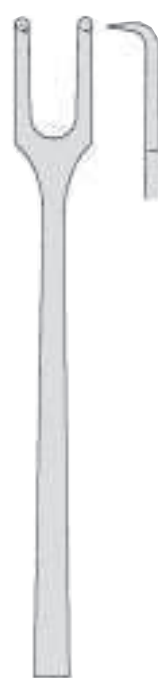

**55.0962**  
2 x 2



**55.0963**  
2 x 2



**SCHROEDER**  
24 cm



**HENROTIN**  
55.0965  
21 cm 2 x 3

**PRATT**  
55.0968  
28 cm

**JACOBS**  
55.0970  
21 cm

55.0971



## TEALE

55.0973 18 cm 3 x 4

55.0975 23 cm 3 x 4



## KÜSTNER

55.0977 25 cm 2 x 3



## MUSEUX

55.0980 24 cm / 6 mm

55.0982 24 cm / 8 mm

55.0984 24 cm / 10 mm



6 mm

8 mm

10 mm

55.0981 24 cm / 6 mm

55.0983 24 cm / 8 mm



**SOMER**  
**55.1500**  
23 cm



**COLLIN**  
**551510**  
25 cm



**COLLIN**  
**55.1511**  
25 cm



**DARTIGUES**  
**55.1520**  
27 cm

Klemmzange / Uterine Hémostatic Forceps /  
Pince-Clamp utérine / Pinza-Clamp uterina / Pinza-Clamp uterina



**GREEN-ARMYTAGE**  
56.0800 22 cm



**GREEN-ARMYTAGE**  
56.0801 20 cm

Kopfschwartzangen / Scalp flap forceps / Pincés pour le  
quir chevelu / Pinzas para pericráneo / Pinze per pericráneo



**MARTEL**  
15.1340 14 cm



**WILLET**  
15.1342 19 cm



**GAUSS**  
56.0805 26 cm

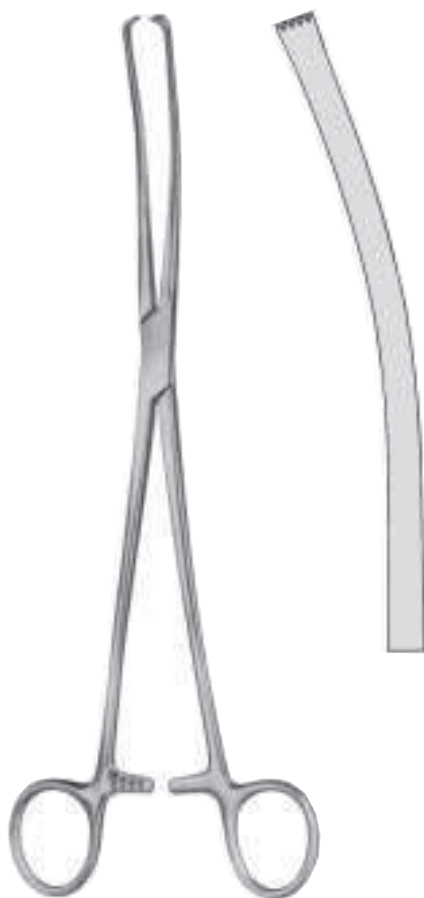

Blasensprenger /  
Membrane puncturing forceps /  
Pince perce-membrane /  
Pinza rompe membrana /  
Pinza rompere membrana

**IOWA**  
56.0820 26 cm



**HEYWOOD-SMITH**  
56.0880 21 cm  
56.0882 25 cm

Uterus-Polymenzangen / Uterine Polypus Forceps /  
Pinces à polypes utérines / Pinzas para pólipos uterinos /  
Pinze per polipi uterini



**DOYEN**  
56.0890 20 cm

Uterus-Polymenzangen / Uterine Polypus Forceps /  
Pincés à polypes utérines / Pinzas para pólipos uterinos /  
Pinze per polipi uterini



**NOTO**  
56.0896 27 cm



**BUMM**  
56.0898 28 cm

Plazentar- und Abortuszangen / Placenta- and Ovum Forceps / Pinces à faux germes /  
 Pinzas para aborto y placenta / Pinze per aborto e placenta



**KELLY**  
 56.0900 32 cm

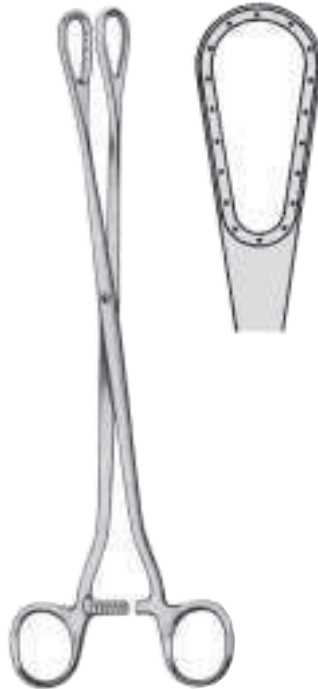

**SAENGER**  
 56.0910 27 cm

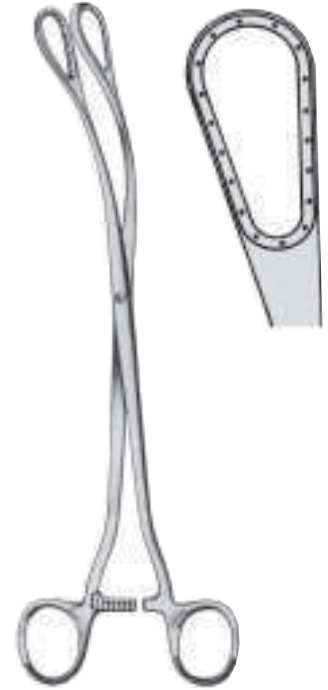

**SAENGER**  
 56.0911 27 cm

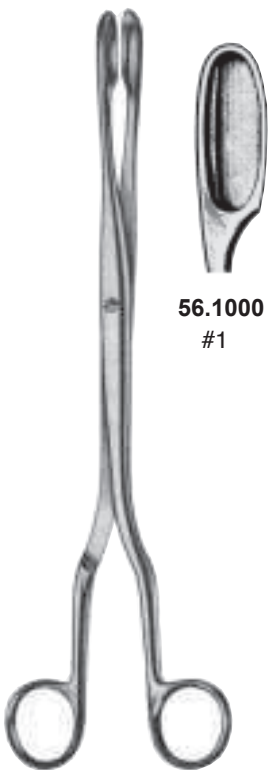

**WINTER**  
 29 cm



56.1000  
 #1



56.1002  
 #2



56.1004  
 #3



**WINTER**  
 29 cm



56.1001  
 #1



56.1003  
 #2



56.1005  
 #3