

PRO-MED



Knochenchirurgie / Neurochirurgie / Mikrochirurgie

Bone Surgery / Neuro Surgery / Micro Surgery

Chirurgie osseuse / Neurochirurgie / Microchirurgie

Cirurgia osea / Neuro Cirurgia / Micro Cirurgia

PRO-MED



17.0721



17.0722



17.0723



17.0724



17.0726



17.0728

scharf / sharp / pointu / agudo



VOLKMANN
21,5 cm



17.0731



17.0732



17.0733



17.0734



17.0736



17.0738

stumpf / blunt / mousse / romo



17.0741



17.0742



17.0743



17.0744



17.0746



17.0748

halbscharf / semi-sharp / semi-pointu / semiagudo



17.0751



17.0752



17.0753



17.0754



17.0756



17.0758

scharf / sharp / pointu / agudo



KOCHER
22 cm



17.0761



17.0762



17.0763



17.0764



17.0766



17.0768

stumpf / blunt / mousse / romo



17.0771



17.0772



17.0773



17.0774



17.0776



17.0778

halbscharf / semi-sharp / semi-pointu / semiagudo

Knochenhaken
Bone Retractors
Ecarteurs pour os
Separadores para huesos

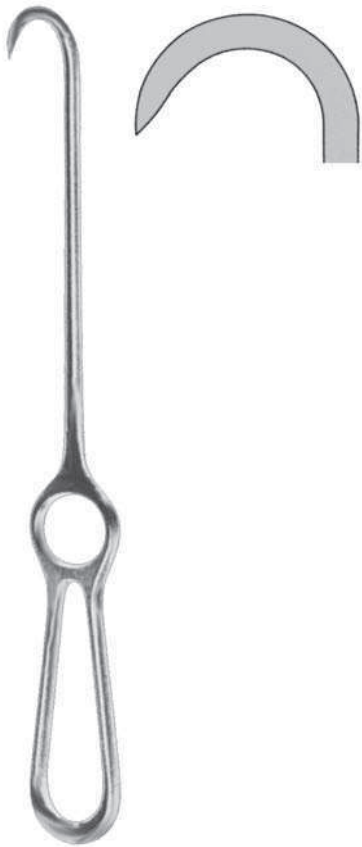

17.0780
25 cm



VOLKMANN
22 cm



17.0781



17.0784



MURPHY
19 cm



17.0822



17.0823



17.0824

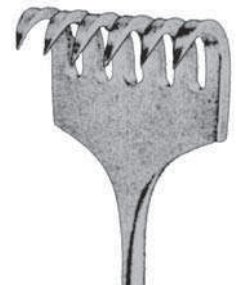

17.0826

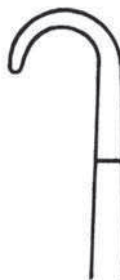

17.0832



17.0833



17.0834



17.0836



WASSMUND
17.0900 20 cm
33 x 20 mm



OLLIER
17.0912 22,5 cm
36 x 60 mm



17.0910
36 x 30 mm

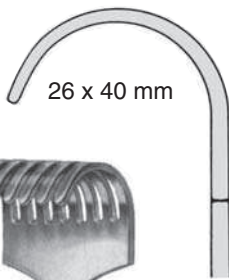

26 x 40 mm



KOERTE
17.0922 24 cm
stumpf
blunt
mousse
romo

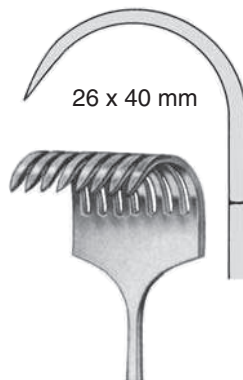

26 x 40 mm

17.0920
scharf
sharp
pointu
agudo



KOERTE
17.0925
23 cm
46 x 55 mm



ISRAEL
25 cm



17.0930
40 x 40 mm



17.0931
45 x 50 mm



17.0932
50 x 60 mm



17.0934
70 x 70 mm



KOCHER

21 cm

- 17.1011 25 x 6 mm
- 17.1012 35 x 8 mm
- 17.1013 35 x 11 mm
- 17.1014 35 x 15 mm
- 17.1015 40 x 11 mm
- 17.1016 55 x 11 mm
- 17.1017 70 x 14 mm
- 17.1018 80 x 12 mm
- 17.1019 80 x 16 mm



KOCHER

23 cm

- 17.1020 40 x 18 mm
- 17.1021 60 x 20 mm
- 17.1022 60 x 25 mm
- 17.1023 75 x 30 mm
- 17.1024 75 x 40 mm
- 17.1025 80 x 20 mm



LANGENBECK
17.1040 - 17.1045
22 cm



17.1040 30 x 11 mm
17.1050 30 x 11 mm



17.1043 40 x 11 mm
17.1053 40 x 11 mm



17.1041 30 x 14 mm
17.1051 30 x 14 mm



17.1044 40 x 15 mm
17.1054 40 x 15 mm



17.1042 30 x 16 mm
17.1052 30 x 16 mm



17.1045 50 x 11 mm
17.1055 50 x 11 mm



LANGENBECK
17.1050 - 17.1055
22 cm



LANGENBECK
17.1049 22 cm
85 x 15 mm

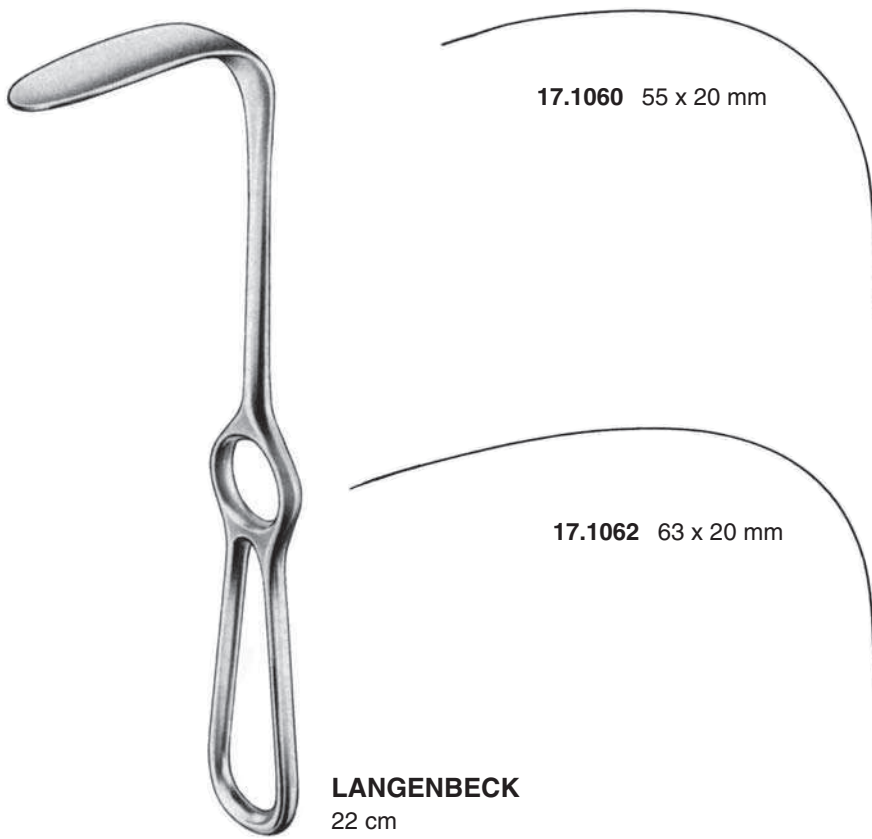

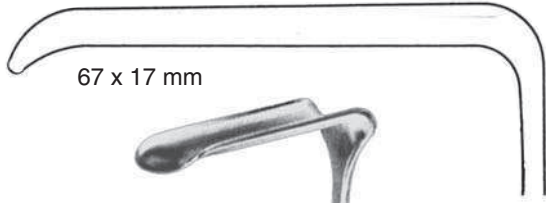

67 x 17 mm



CASPAR
27.5222
20 cm



DOCKHORN
20 cm



34.4020
40 x 12 mm



34.4022
55 x 14 mm



MIDDELDORPF
22 cm
17.1080 16 x 17 mm
17.1081 20 x 22 mm
17.1082 26 x 30 mm



MIDDELDORPF
23 cm
17.1086 20 x 22 mm
17.1087 26 x 30 mm



GREEN
17.1088 22 cm

Knie-Wundhaken
 Retractors for knee
 Ecarteurs pour genou
 Separadores para rodilla



SMILLIE
 14 cm

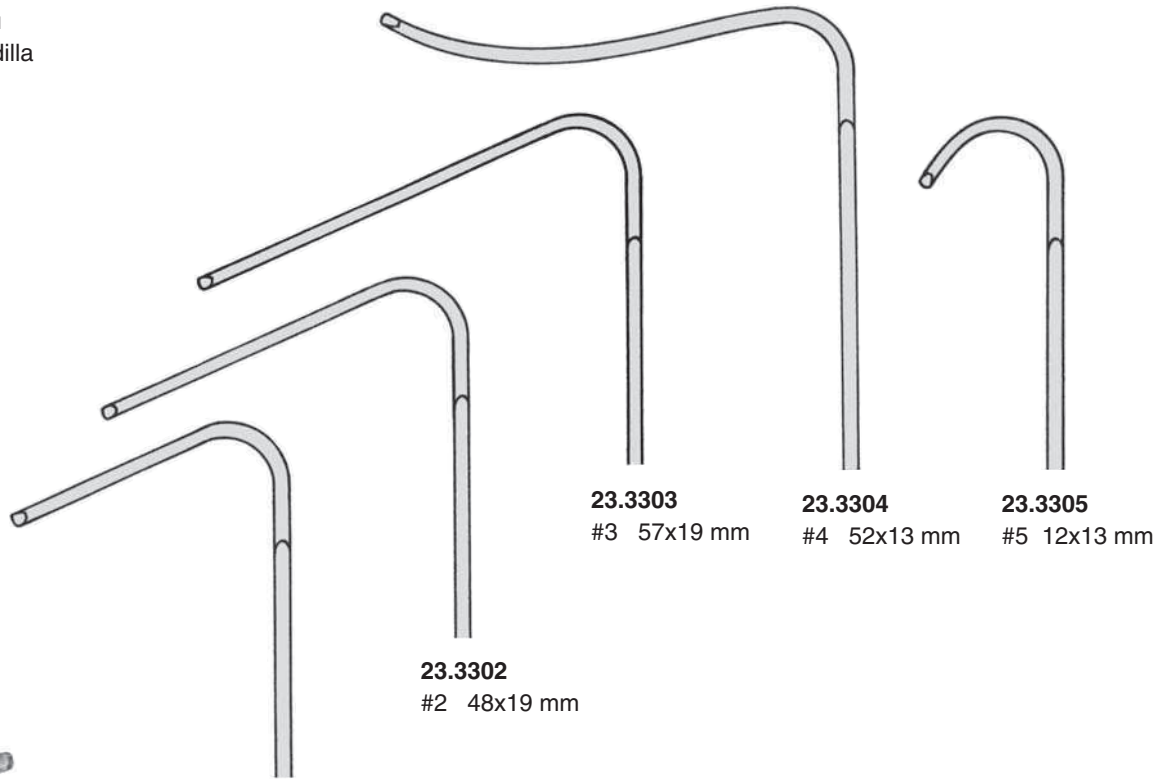

23.3301
 #1 32x19 mm

23.3302
 #2 48x19 mm

23.3303
 #3 57x19 mm

23.3304
 #4 52x13 mm

23.3305
 #5 12x13 mm



BLOUNT
23.3310 18 cm



23.3312
 21 cm / 38 x 9 mm



MEYERDING
17.1160 22 cm
 50 x 16 mm
17.1162 22 cm
 75 x 25 mm
17.1164 24 cm
 90 x 50 mm

geriefte Valven
Serrated blades
valves striées
valvas estriadas

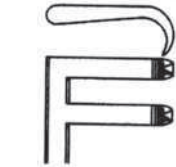

17.5206 13 cm

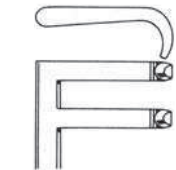

17.5207 13 cm

PLESTER



COX
17.5210
12 cm

für Finger und Zehen
Finger- and Toe Retractor
pour doigts et orteils
para dedos



SCALP-CONTOUR

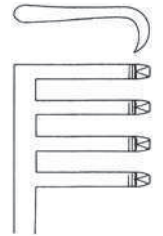

17.5224 14 cm

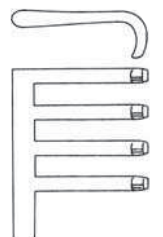

17.5225 14 cm



WEITLANER-BABY
17.5290 14 cm

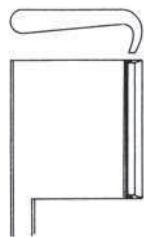

WEITLANER

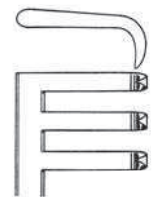

17.5300 10,5 cm

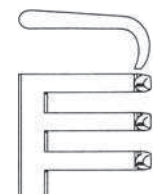

17.5301 10,5 cm



WEITLANER

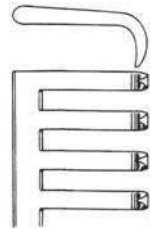

17.5302 14 cm
17.5304 16,5 cm

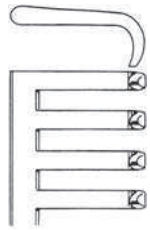

17.5303 14 cm
17.5305 16,5 cm



WEITLANER

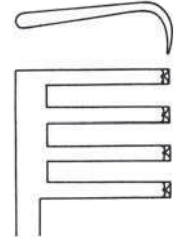

17.5306 20 cm

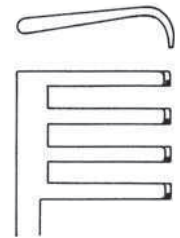

17.5307 20 cm



WEITLANER



17.5308 24 cm



17.5309 24 cm



ADSON

17.5320 19 cm scharf/sharp/pointu/agudo
17.5321 19 cm stumpf/blunt/mousse/romo



NORFOLK-NORWICH
17.5340
20 cm

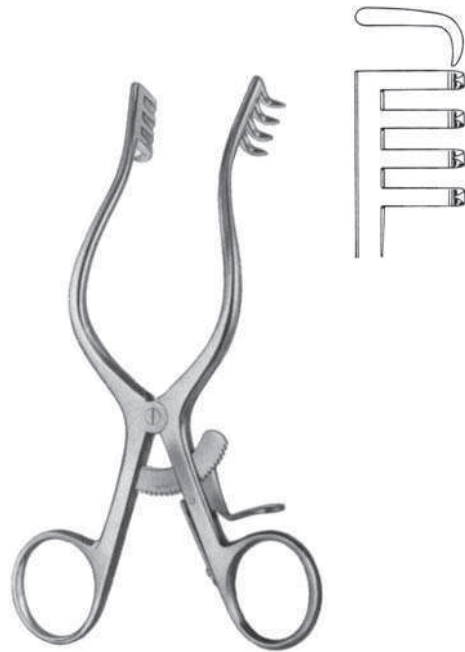

MOLLISON
17.5406 15 cm

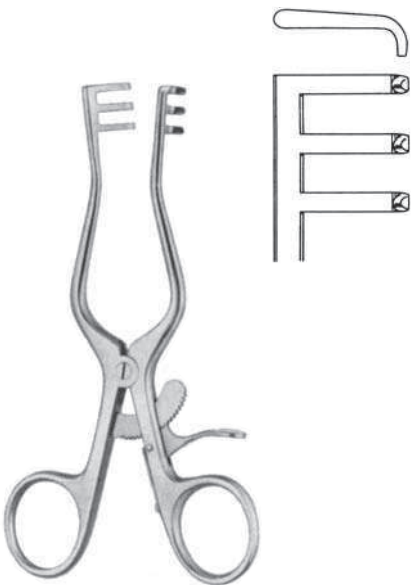

MILLIGAN
17.5410 13 cm

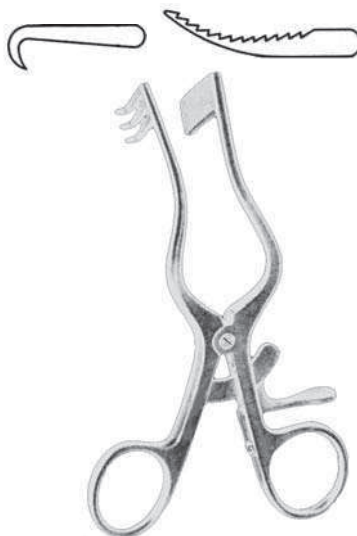

PERKINS-R
17.5446
13 cm



PERKINS-L
17.5447
13 cm

spitz
sharp
pointu
agudo

stumpf
blunt
mousse
romo

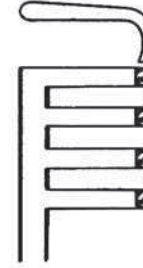

17.5600
14 cm

17.5601
14 cm

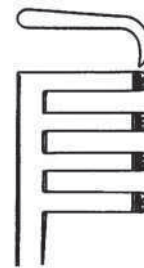

17.5602
16,5 cm

17.5603
16,5 cm

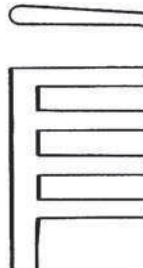
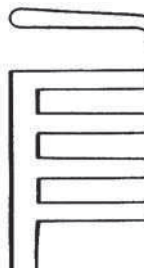

17.5604
20 cm

17.5605
20 cm

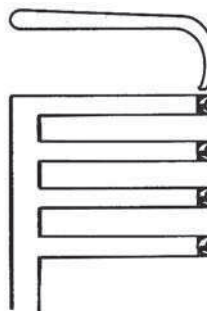
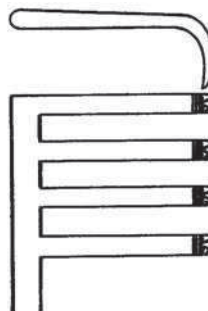

17.5606
26 cm

17.5607
26 cm



BECKMANN-WEITLANER
(Adson)

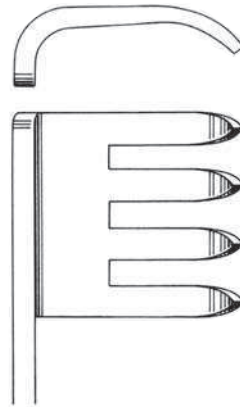
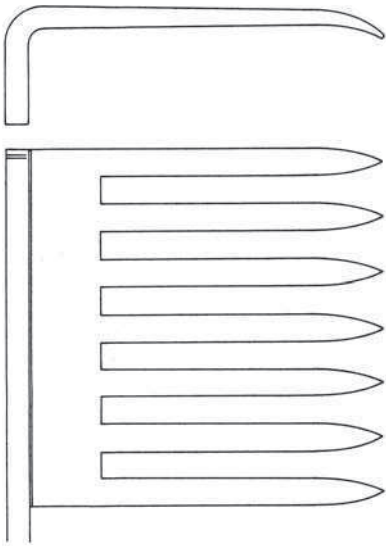

17.5635 25 mm

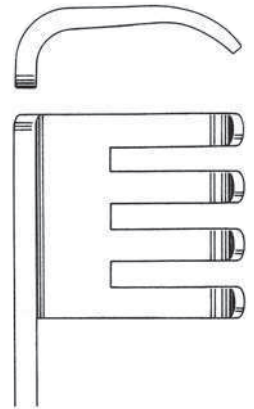

17.5636 25 mm



BECKMANN-EATON
17.5620 32 cm



BECKMANN-ADSON
31 cm

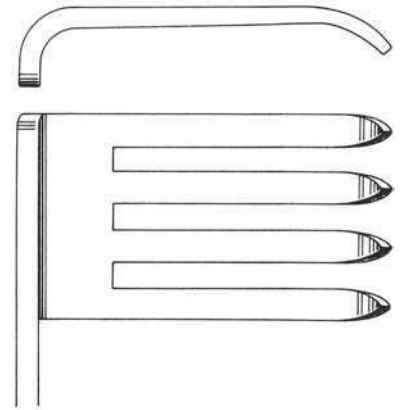

17.5637 44 mm

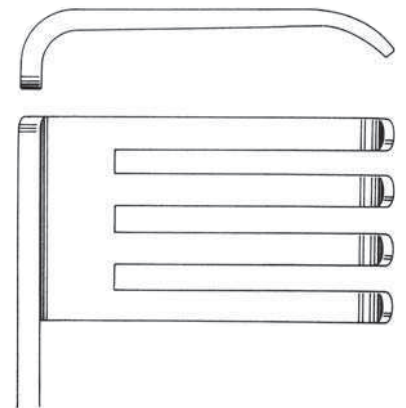

17.5638 44 mm

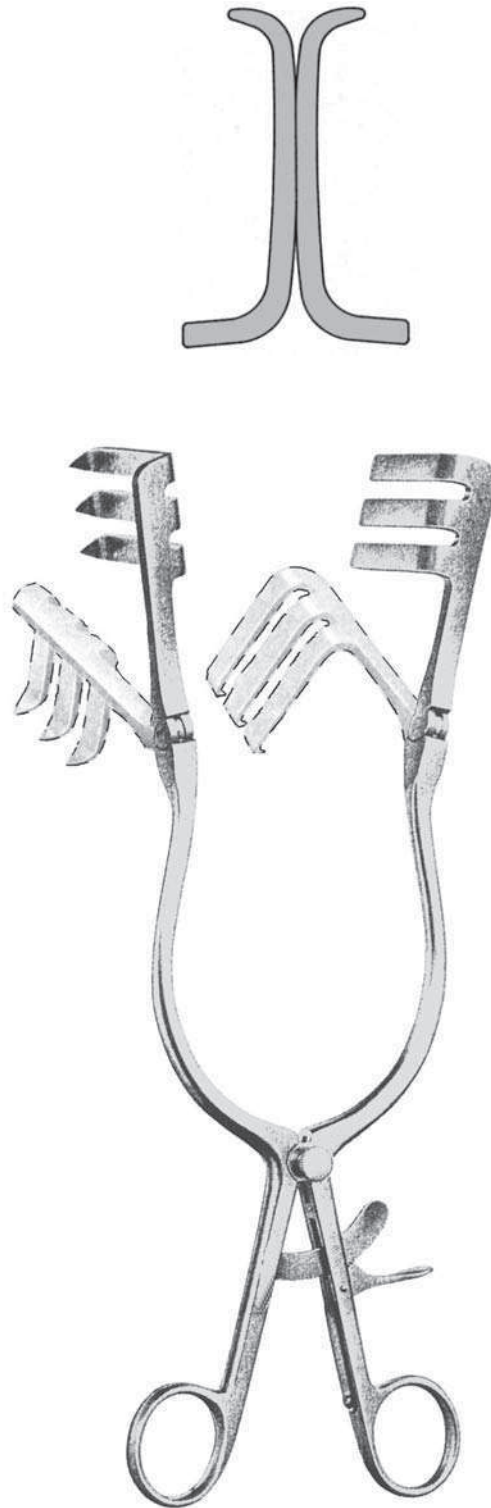

HARVEY-JACKSON
17.5640
28 cm

76x40

64x25 mm



DARLING
17.5670 18 cm

64x25

76x40 mm



DARLING
17.5672 18 cm



GELPI-MINI
17.5899 10 cm

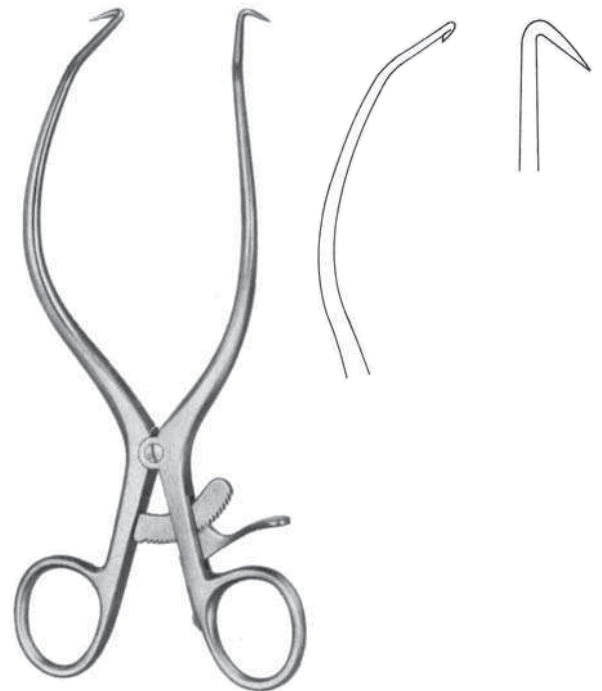

GELPI-BABY
17.5900 14 cm



GELPI
17.5901 18 cm



GELPI-SELETZ
17.5907 15 cm



JACKSON-BURROWS
17.5908 18,5 cm



COMPRIMETER
22.0010

komplett mit Manschette für Oberarm und Oberschenkel
complete with cuff for upper arm and leg
complet avec manchette pour bras et la cuisse
completo con brazaletes para el mizlo & el brazo

22.0011

Oberarm-Manschette
Cuff for the upper arm
Manchette pour le bras
Brazaletes para brazo

22.0012

Oberschenkel-Manschette
Cuff for the leg
Manchette pour la cuisse
Brazaletes para pierna

22.0013

Manschette für Kinder
Cuff for children
Manchette pour enfants
Brazaletes para niños

22.0015

Luftpumpe mit Manometer
Pump with manometer only
Pompe avec manometre, seuls
Bomba neumatica con manometro



ESMARCH
22.0020

Staubinde 5 m x 6 cm
Compression Bandage 5 m x 6 cm
Bande-compression 5 m x 6 cm
Banda-compresión 5 m x 6 cm

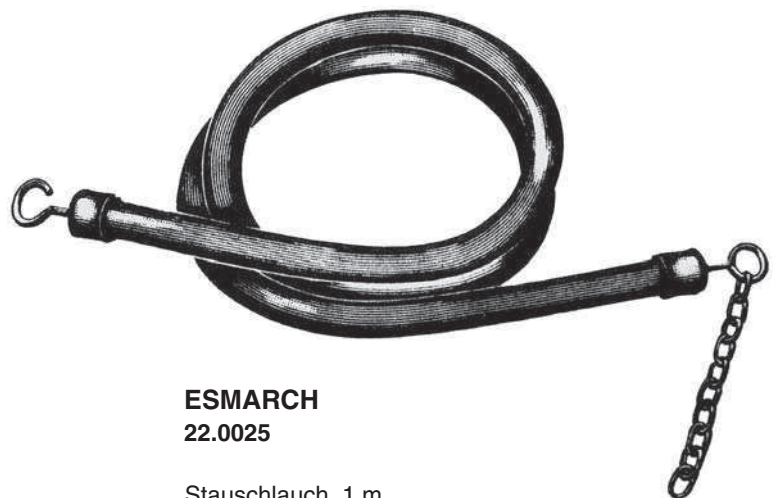

ESMARCH
22.0025

Stauschlauch 1 m
Compression Tube 1 m
Garrot 1 m
Tubo-compresión 1 m

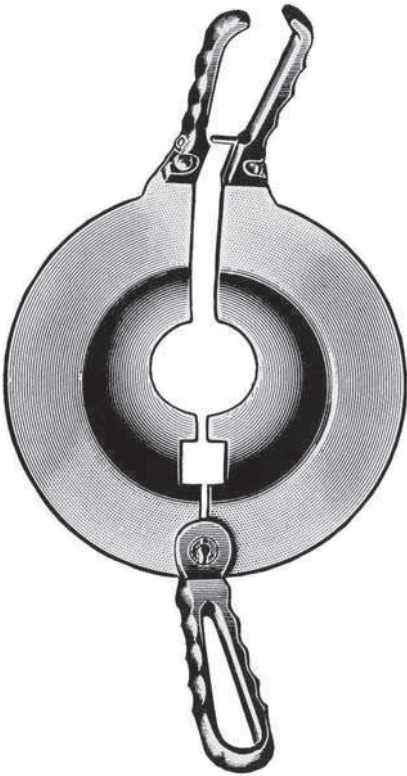

PERCY
22.0050
 mit abnehmbaren Griffen
 with detachable handles
 avec poignées démontables
 con mangos desmontables



LANGENBECK
22.0100 23 cm



CHARRIERE
22.0110 30 cm

22.0111
 Ersatzsägeblatt/spare saw blade/
 lame de rechange/hoja de repuesto



Ersatzsägeblatt
 spare saw blade
 lame de rechange
 hoja de repuesto



CHARRIERE
22.0115 35 cm

22.0116 12 mm
22.0117 15 mm



SATTERLEE
22.0120 31 cm

22.0129
 Ersatzsägeblatt/spare saw blade/
 lame de rechange/hoja de repuesto



BIER
22.0130 42 cm

Ersatzsägeblatt
 spare saw blade
 lame de rechange
 hoja de repuesto



22.0134 4 mm
22.0136 6 mm
22.0138 8 mm