

PINZETTEN
FORCEPS
PINCES
PINZAS
PINZE

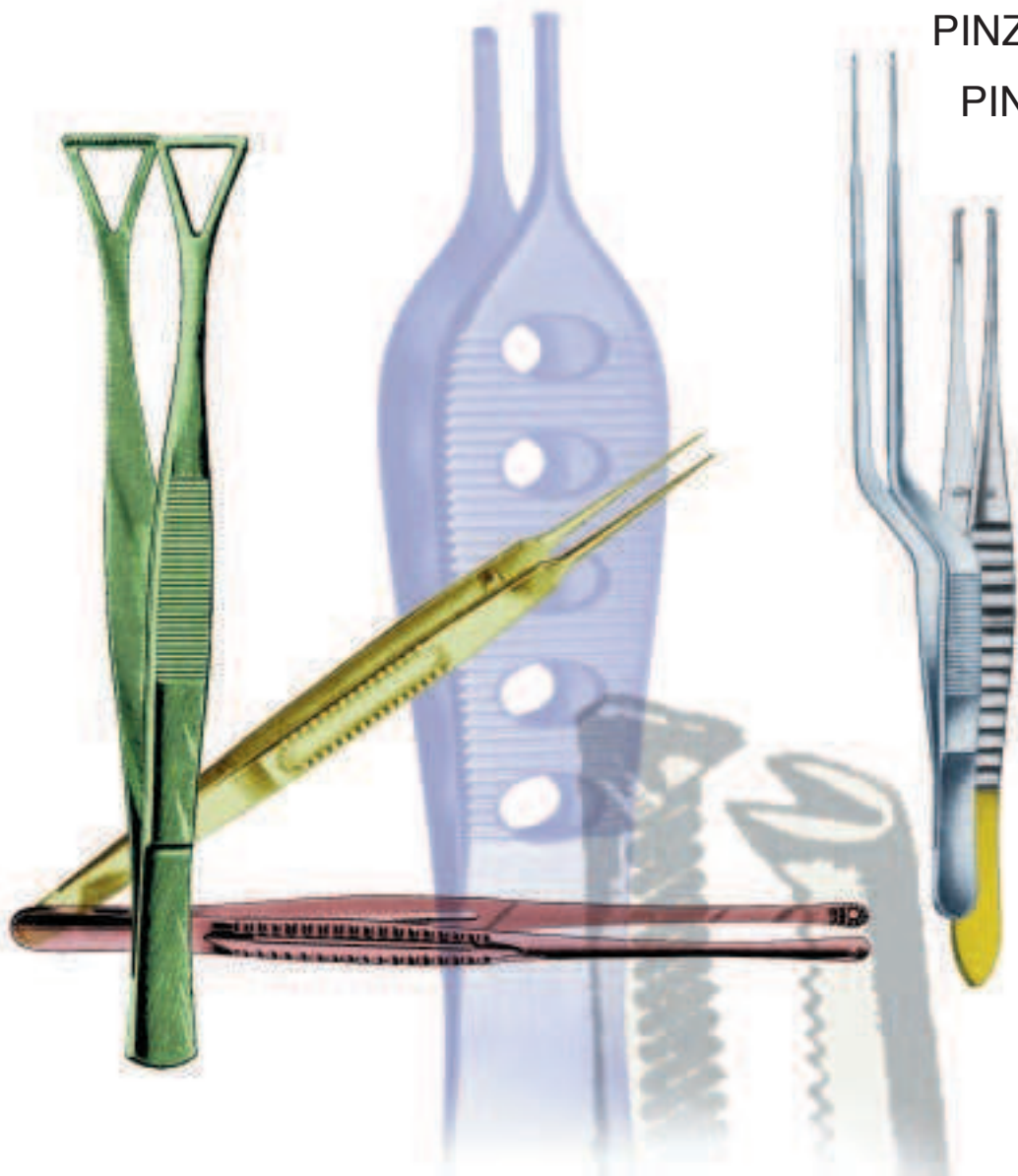

TITANIUM



GRAEFE
14.0010 10 cm



GRAEFE
14.0011 10 cm



GRAEFE
14.0013 10 cm



GRAEFE-SELECT
10 cm



30.2000
0,8 mm



30.2001
0,8 mm



30.2003
0,8 mm



45°
30.2009
0,8 mm



30.2000 T
0,8 mm



30.2001T
0,8 mm



30.2003T
0,8 mm

TITANIUM



GRAEFE-SELECT
10 cm



30.2004
0,5 mm



30.2005
0,5 mm



30.2007
0,5 mm

Uhrmacher-Pinzetten / Jeweller Type Forceps / Pincés d'horloger
 /Pinzas de relojero / Pinze de orologiaio



JUWELIER #1
 14.1600 11,5 cm



JUWELIER #3
 14.1602 11,5 cm



JUWELIER #3C
 14.1603 10,5 cm



JUWELIER #4
 14.1604 11 cm



JUWELIER #5
 14.1605 11 cm



JUWELIER #7
 14.1607 11,5 cm



MIKRO
 15.5 cm



14.0380
 0,6 mm



14.0382
 0,8 mm



14.0384
 1,0 mm



PRO-MED Select
 14.1614 11 cm



PRO-MED Select
 14.1617 11.5 cm

TITANIUM



ADSON
 14.0026 12 cm



ADSON-MICRO
 14.0028 12 cm



ADSON-MICRO
 14.0030 12 cm
 14.0032 15 cm



ADSON
 14.0040 12 cm
 14.0040T 12 cm
 14.0042 15 cm
 14.0042T 15 cm



12 cm

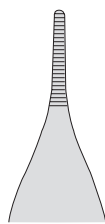

EWALD
 14.0049

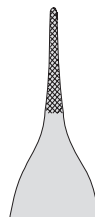

ADSON
 "Criss-Cross"
 14.0050



ADSON-DEBAKEY
 14.0546 12,5 cm
 14.0547 15,0 cm

TITANIUM



ADSON
 14.0044 18 cm



JEFFERSON
 14.0056 18 cm



SEMKEN



14.0060 12 cm
 14.0060T 12 cm
 14.0062 15 cm



14.0061
 14.0063



McINDOE



14.0070 15 cm
 14.0070T 15 cm

TITANIUM



DRESSING-FINO

- 14.0100 10,5 cm
- 14.0101 11,5 cm
- 14.0102 13,0 cm
- 14.0103 14,5 cm
- 14.0104 15,0 cm
- 14.0105 16,0 cm
- 14.0107 18,0 cm
- 14.0108 20,0 cm
- 14.0108T 20,0 cm**
- 14.0109 25,0 cm



DRESSING-FINO

- 14.0110 10,5 cm
- 14.0111 11,5 cm
- 14.0112 13,0 cm
- 14.0113 14,5 cm
- 14.0114 15,0 cm
- 14.0115 16,0 cm
- 14.0116 18,0 cm
- 14.0117 20,0 cm
- 14.0118 25,0 cm
- 14.0119 30,0 cm



DRESSING

- 14.0120 10,5 cm
- 14.0121 11,5 cm
- 14.0122 13,0 cm
- 14.0123 14,5 cm
- 14.0123T 14,5 cm**
- 14.0124 15,0 cm
- 14.0125 16,0 cm
- 14.0127 18,0 cm
- 14.0128 20 cm
- 14.0128T 20,0 cm**
- 14.0129 25,0 cm
- 14.0130 30,0 cm



DRESSING

- 14.0151 11,5 cm
- 14.0152 13,0 cm
- 14.0153 14,5 cm
- 14.0154 15,0 cm
- 14.0155 16,0 cm
- 14.0157 18,0 cm
- 14.0158 20,0 cm



DRESSING-USA

- 14.0181 11,5 cm
- 14.0182 13,0 cm
- 14.0183 14,5 cm
- 14.0184 15,5 cm
- 14.0187 18,0 cm
- 14.0188 20,0 cm
- 14.0189 25,0 cm



STILLE

- 14.0202 13 cm
- 14.0204 15 cm
- 14.0207 17 cm
- 14.0220 20 cm



BLANK

- 14.0142 13,0 cm
- 14.0143 14,5 cm
- 14.0144 16,0 cm



BROPHY

- 14.0300 20 cm



BROPHY

- 14.0301 20 cm

TITANIUM



CUSHING
14.0310 18 cm



CUSHING
14.0311 18 cm



GERALD
14.0320 18 cm
14.0320T 18 cm



GERALD
14.0321 18 cm



GERALD
14.0325 18 cm

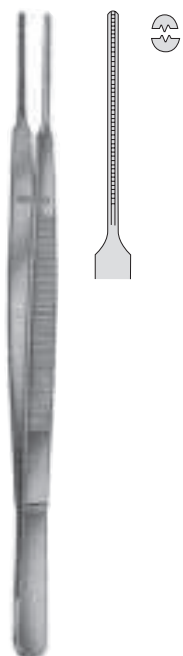

DEBAKEY-GERALD
14.0328 18 cm



DUEHRSSSEN
14.0330 20 cm



RAMSEY
14.0340 18 cm



BONNEY
14.0390 18 cm



POTTS-SMITH
14.0350 18 cm
14.0350T 18 cm
14.0352 21 cm
14.0352T 21 cm
14.0354 25 cm
14.0354T 25 cm

TITANIUM

glatt / smooth / lisse / lisa / liscio



POTTS-SMITH
 14.0351 18 cm
 14.0353 21 cm

POTTS-SMITH
 14.0356 18 cm
 14.0358 21 cm



TAYLOR
 14.0360 18 cm
 14.0360T 18 cm



14.0361 18 cm
 14.0361T 18 cm



14.0366 18 cm

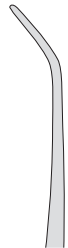

14.0367 18 cm



TAYLOR-CUSHING
 14.0362 18 cm



TAYLOR-CUSHING
 14.0365 18 cm



WAUGH
 14.0368 15 cm
 14.0370 20 cm



GRAEFE
 14.0510
 10 cm 1x2



14.0511
 10 cm 1x2



14.0513
 10 cm 1x2



GRAEFE-SELECT
 10 cm



30.2010
 0,8 mm
 1x2



30.2011
 0,8 mm
 1x2



30.2013
 0,8 mm
 1x2



GRAEFE-SELECT
 10 cm



30.2014
 0,5 mm
 1x2



30.2015
 0,5 mm
 1x2



30.2017
 0,5 mm
 1x2



MIKRO
 15.5 cm



14.0780
 0,6 mm



14.0782
 0,8 mm



14.0784
 1,0 mm

TITANIUM



ADSON
14.0526
 12 cm 1x2



ADSON-SELECT-MICRO
14.0527
 12 cm 1x2



ADSON-MICRO
14.0528
 12 cm 1x2



ADSON-MICRO
14.0530 12 cm
14.0532 15 cm



ADSON
14.0540 12 cm
14.0540T 12 cm
14.0542 15 cm



ADSON
14.0541 12 cm 2x3

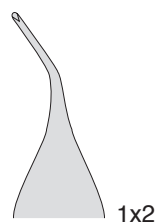

ADSON
14.0543 12 cm 45° 1x2
14.0545 15 cm 45° 1x2



EWALD
14.0549 12 cm

TITANIUM



ADSON-GRAEFE
 14.0548 12 cm

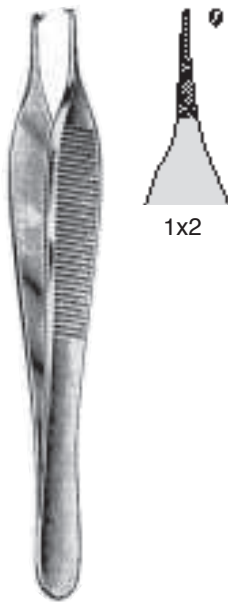

ADSON
 "Criss-Cross"
 14.0550 12 cm



ADSON
 14.0554 18 cm



JEFFERSON
 14.0556 18 cm



SEMKEN
 14.0560 12 cm
 14.0562 15 cm

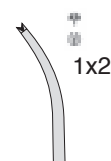

SEMKEN
 14.0561 12 cm
 14.0563 15 cm

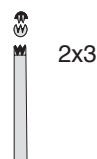

SEMKEN
 14.0566 12 cm



GILLIES
 14.0570 15 cm
 14.0570T 15 cm



TISSUE-FINO

- 14.0600 10,5 cm 1x2
- 14.0601 11,5 cm 1x2
- 14.0602 13,0 cm 1x2
- 14.0603 14,5 cm 1x2
- 14.0604 15,0 cm 1x2
- 14.0605 16,0 cm 1x2
- 14.0607 18,0 cm 1x2
- 14.0608 20,0 cm 1x2
- 14.0609 25,0 cm 1x2



TISSUE

- 14.0620 10,5 cm 1x2
- 14.0621 11,5 cm 1x2
- 14.0622 13,0 cm 1x2
- 14.0623 14,5 cm 1x2
- 14.0624 15,0 cm 1x2
- 14.0625 16,0 cm 1x2
- 14.0627 18,0 cm 1x2
- 14.0628 20,0 cm 1x2
- 14.0629 25,0 cm 1x2
- 14.0630 30,0 cm 1x2



TISSUE

- 14.0653 14,0 cm 1x2
- 14.0657 18,0 cm 1x2



TISSUE-USA

- 14.0681 12,0 cm 1x2
- 14.0682 13,0 cm 1x2
- 14.0683 14,5 cm 1x2
- 14.0684 15,5 cm 1x2
- 14.0687 18,0 cm 1x2
- 14.0688 21,0 cm 1x2
- 14.0689 25,0 cm 1x2



TISSUE

- 14.0701 11,5 cm 2x3
- 14.0702 13,0 cm 2x3
- 14.0703 14,5 cm 2x3
- 14.0704 15,0 cm 2x3
- 14.0705 16,0 cm 2x3
- 14.0707 18,0 cm 2x3
- 14.0708 20,0 cm 2x3
- 14.0709 25,0 cm 2x3



TISSUE

- 14.0722 13,0 cm 3x4
- 14.0723 14,5 cm 3x4
- 14.0724 15,0 cm 3x4
- 14.0725 16,0 cm 3x4
- 14.0727 18,0 cm 3x4
- 14.0728 20,0 cm 3x4

TITANIUM



TISSUE

- 14.0732 13,0 cm 4x5
- 14.0733 14,5 cm 4x5
- 14.0734 15,0 cm 4x5
- 14.0735 16,0 cm 4x5



FERRIS-SMITH

14.0790 18 cm 1x2



FERRIS-SMITH

14.0792 18 cm 2x3



BROPHY

14.0800 20 cm 1x2



BROPHY

14.0801 20 cm 1x2



GERALD

14.0820 18 cm 1x2

14.0820T 18 cm 1x2



GERALD

14.0821 18 cm 1x2

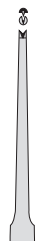

GERALD

14.0825 18 cm 1x2



DUEHRSEN
 14.0830 20 cm 1x2



RAMSEY
 14.0840 18 cm 1x2



RAMSEY
 14.0842 18 cm 2x3



POTTS-SMITH
 14.0850 18 cm 1x2
 14.0852 21 cm 1x2
 14.0854 25 cm 1x2



POTTS-SMITH
 14.0851 18 cm 1x2
 14.0853 21 cm 1x2
 14.0855 25 cm 1x2



TAYLOR
 14.0860 18 cm



TAYLOR
 14.0861 18 cm



TAYLOR-CUSHING
 14.0862 18 cm



TAYLOR-CUSHING
 14.0865 18 cm

TITANIUM



ALDERKREUZ
14.0866 15 cm 2x3
14.0867 20 cm 2x3



ALDERKREUZ
14.0868 15 cm 4x5
14.0869 20 cm 4x5



TREVES
14.0870 13 cm 1x2
14.0872 15 cm 1x2



LERCHE
14.0880 15 cm 5x6



STONE
14.0885 15 cm 4x5



BONNEY
14.0890
18 cm 1x2



BONNEY
14.0892
18 cm 2x3



NELSON
14.0895 15 cm
14.0896 20 cm
14.0897 23 cm



ADSON-BROWN
14.0900 12 cm 9x9
14.0900T 12 cm 9x9



ADSON-BROWN
14.0904 12 cm 9x9



BROWN
 14.0910 15 cm
 14.0912 20 cm
 14.0914 25 cm



LANE
 14.0920 14,5 cm 1x2
 14.0922 20,0 cm 1x2



LANE
 14.0925 14,5 cm 2x3
 14.0927 20,0 cm 2x3



RUSSIAN
 14.0930 15 cm
 14.0932 20 cm
 14.0934 25 cm



MAYO-RUSSIAN
 14.0940 23 cm



WANGENSTEEN
 14.0948 23 cm



SINGLEY (TUTTLE)
 14.0950 15 cm
 14.0952 18 cm
 14.0954 23 cm



STILLE-BARRAYA

- 14.0960 18 cm
- 14.0962 20 cm
- 14.0964 25 cm



WAUGH

- 14.0968 15 cm
- 14.0970 20 cm



14.0980
14,5 cm



14.0982
16 cm



14.0984
20 cm

DURANTE



DENIS-BROWN
14.0988 18 cm



DUVAL
14.0990 14,5 cm



COLLIN-DUVAL
14.0994 20 cm, 14 mm
14.0996 20 cm, 18 mm
14.0998 20 cm, 27 mm

TITANIUM



DEBAKEY

- 14.1000 15 cm / 1,5 mm
- 14.1002 20 cm / 1,5 mm
- 14.1004 24 cm / 1,5 mm
- 14.1006 30 cm / 1,5 mm



DEBAKEY

- 14.1007 T 16 cm / 1,5 mm
- 14.1008 T 20 cm / 1,5 mm
- 14.1009 T 24 cm / 1,5 mm



DEBAKEY

- 14.1010 15 cm/2 mm
- 14.1010T 15 cm/2 mm
- 14.1012 20 cm/2 mm
- 14.1012T 20 cm/2 mm
- 14.1014 24 cm/2 mm
- 14.1014T 24 cm/2 mm
- 14.1016 30 cm/2 mm
- 14.1016T 30 cm/2 mm



DEBAKEY

- 14.1017 T 16 cm/1,8 mm
- 14.1018 T 20 cm/1,8 mm
- 14.1019 T 24 cm/1,8 mm



DEBAKEY

- 14.1021 16 cm /2 mm
- 14.1021T 16 cm /2 mm
- 14.1023 20 cm /2 mm
- 14.1023T 20 cm /2 mm
- 14.1025 24 cm /2 mm
- 14.1025T 24 cm /2 mm
- 14.1027 30 cm /2 mm
- 14.1027T 30 cm /2 mm



DEBAKEY

- 14.1030 16 cm /2,7 mm
- 14.1030T 16 cm /2,7 mm
- 14.1032 20 cm /2,7 mm
- 14.1032T 20 cm /2,7 mm
- 14.1034 24 cm /2,7 mm
- 14.1034T 24 cm /2,7 mm
- 14.1036 30 cm /2,7 mm
- 14.1036T 30 cm /2,7 mm

TITANIUM



DEBAKEY

- 14.1040 15 cm /3,5 mm
- 14.1040T 15 cm /3,5 mm
- 14.1042 20 cm /3,5 mm
- 14.1042T 20 cm /3,5 mm
- 14.1044 24 cm /3,5 mm
- 14.1044T 24 cm /3,5 mm
- 14.1046 30 cm /3,5 mm
- 14.1046T 30 cm /3,5 mm



COOLEY

- 14.1050 15 cm/2 mm
- 14.1050T 15 cm/2 mm
- 14.1052 20 cm/2 mm
- 14.1052T 20 cm/2 mm
- 14.1054 24 cm/2 mm
- 14.1054T 24 cm/2 mm



DEBAKEY

- 14.1060 15 cm /1 mm
- 14.1060T 15 cm /1 mm
- 14.1062 20 cm /1 mm
- 14.1062T 20 cm /1 mm
- 14.1064 24 cm /1 mm
- 14.1064T 24 cm /1 mm

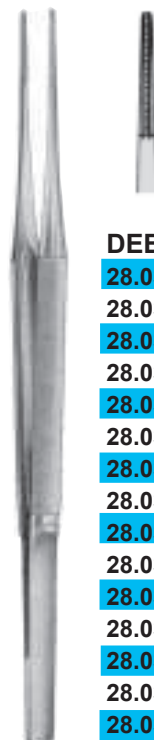

DEBAKEY

- 28.0320 15 cm /1,2 mm TITAN
- 28.0320S 15 cm /1,2 mm
- 28.0322 18 cm /1,2 mm TITAN
- 28.0322S 18 cm /1,2 mm
- 28.0324 21 cm /1,2 mm TITAN
- 28.0324S 21 cm /1,2 mm
- 28.0326 23 cm /1,2 mm TITAN
- 28.0326S 23 cm /1,2 mm
- 28.0330 15 cm /2,0 mm TITAN
- 28.0330S 15 cm /2,0 mm
- 28.0332 18 cm /2,0 mm TITAN
- 28.0332S 18 cm /2,0 mm
- 28.0334 21 cm /2,0 mm TITAN
- 28.0334S 21 cm /2,0 mm
- 28.0336 23 cm /2,0 mm TITAN
- 28.0336S 23 cm /2,0 mm



GLASSMANN



14.1070
15 cm 4 mm



14.1072
24 cm 8 mm

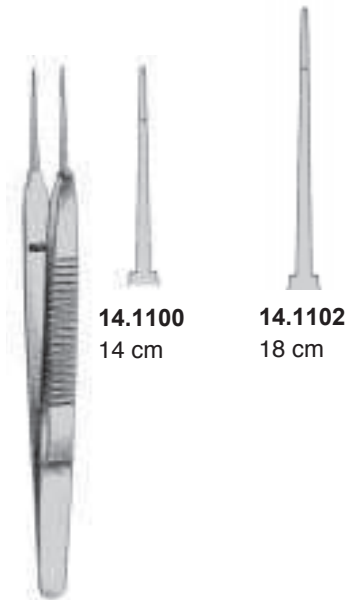

14.1100
14 cm

14.1102
18 cm

AUSTIN



WISE
14.1110
12 cm 0,3 mm



WISE
14.1112
13,5 cm 0,3 mm



WISE
14.1113
13,5 cm 0,3 mm

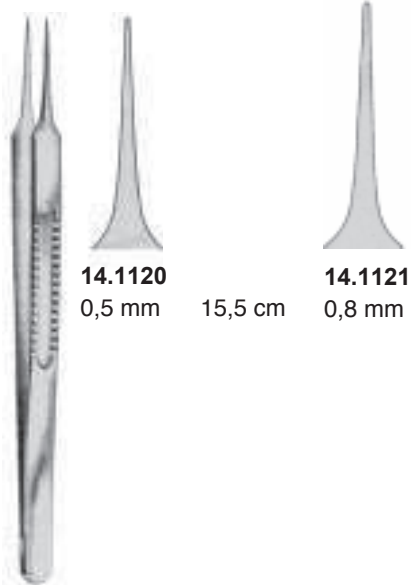

14.1120
0,5 mm 15,5 cm

14.1121
0,8 mm

LAZAR



LAZAR
14.1122
18,5 cm 0,5 mm



- | | |
|------------------------|------------------------|
| 14.1500 9,0 cm | 14.1505 9,0 cm |
| 14.1501 10,0 cm | 14.1506 10,0 cm |
| 14.1502 11,5 cm | 14.1507 11,5 cm |
| 14.1503 13,0 cm | 14.1508 13,0 cm |
| 14.1504 14,0 cm | 14.1509 14,0 cm |

HUNTER



14.1510
10,5 cm



14.1511
10,5 cm

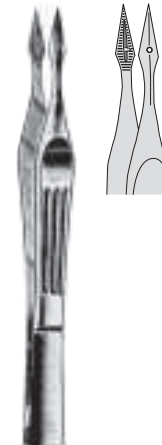

CARMALT
14.1520 10,5 cm

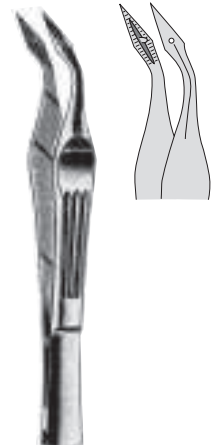

CARMALT
14.1521 10,5 cm

Mikroskopiepinzetten
 Microscopic Forceps
 Pinzes à microscopie
 Pinzas para microscopia
 Pinze per microscopia

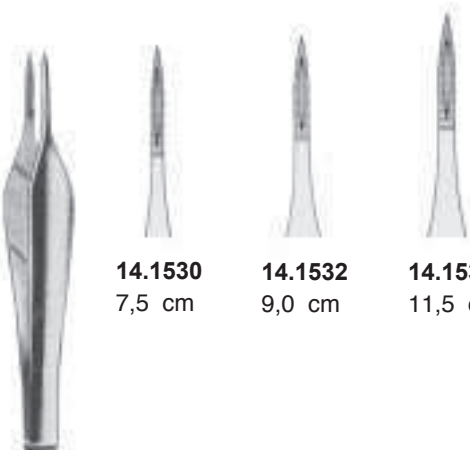

14.1530
7,5 cm

14.1532
9,0 cm

14.1534
11,5 cm

FEILCHENFELD



14.1540
10 cm



14.1542
10 cm



PEET
 14.1560
 11,5 cm

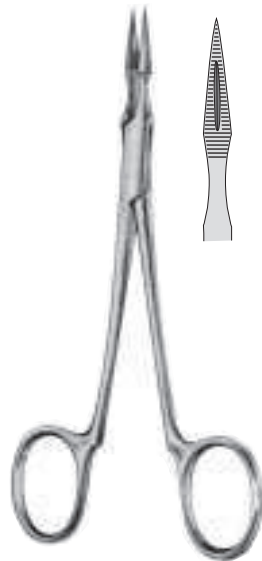

ARTHUR
 14.1570
 14cm

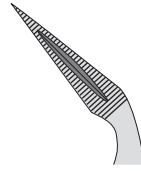

14.1571
 14 cm



STIEGLITZ
 14.1580
 14 cm

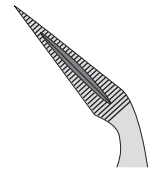

14.1581
 14 cm

Deckglaspinzetten / Cover glass forceps / Pincès port-laminaires /
 Pinzas porta-laminilla / Pinze con copertura vetrificata



VIRTUS (RALK)

14.1590

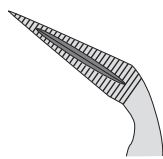

14.1591



KUEHNE
 14.1700
 10,5 cm



KUEHNE
 14.1702
 10,5 cm



KUEHNE
 14.1705
 10,5 cm



KUEHNE
 14.1707
 10,5 cm



SHAAF
30.2811
9,5 cm



BARRAQUER
30.2840
10,5 cm



DOUGLAS
30.2850
9 cm



DOUGLAS
30.2852
9 cm



BEER
30.2862
9 cm



BERGH
30.2865
9 cm



LITTAUER
30.2870
8,5 cm



HENRY
30.2885
12 cm



14.2001 12 cm
 glatt / smooth
 lisse / lisa / liscio



ADSON
14.2005 12 cm 1x2
14.2007 15 cm 1x2



SEMKEN
14.2010 15 cm



CUSHING
14.2020 18 cm

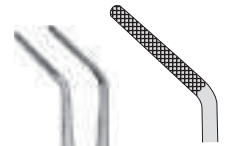

CUSHING
14.2021 18 cm



CUSHING
14.2023 19 cm



POTTS-SMITH
14.2049 15 cm
14.2050 18 cm
14.2052 21 cm
14.2054 25 cm



WANGENSTEEN
14.2070 15 cm
14.2072 23 cm
14.2074 25 cm



1.8 mm

DRESSING
14.2103 14,5 cm
14.2105 16,0 cm
14.2107 18,0 cm
14.2108 20,0 cm
14.2109 25,0 cm
14.2110 30,0 cm

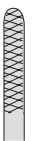

2.7 mm

DRESSING
14.2122 13,0 cm
14.2123 14,5 cm
14.2125 16,0 cm
14.2127 18,0 cm
14.2128 20,0 cm
14.2129 25,0 cm
14.2130 30,0 cm



MC INDOE
 14.2170 15 cm



DEBAKEY
 14.2200
 15 cm / 1,5 mm
 14.2202
 19 cm / 1,5 mm
 14.2204
 24 cm / 1,5 mm



DEBAKEY
 14.2210
 15 cm / 2 mm
 14.2212
 19 cm / 2 mm
 14.2214
 24 cm / 2 mm

DEBAKEY
 14.2220
 15 cm / 2,7 mm
 14.2222
 19 cm / 2,7 mm
 14.2224
 24 cm / 2,7 mm

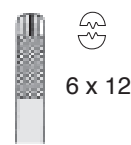

DEBAKEY
 14.2230
 15 cm / 3,5 mm
 14.2232
 19 cm / 3,5 mm
 14.2234
 24 cm / 3,5 mm



DEBAKEY
 14.2240
 15 cm / 2 mm
 14.2242
 19 cm / 2 mm
 14.2244
 24 cm / 2 mm



GERALD
 14.2320 18 cm



BONNEY
 14.2390 18 cm



GERALD
 14.2820 18 cm 1x2



GILLIES
 14.2570 15 cm 1x2



OEHLER

14.2623 14 cm
14.2625 16 cm
14.2627 18 cm
14.2628 20 cm
14.2629 25 cm
14.2630 30 cm



BONNEY

14.2890 18 cm 1x2



ADSON-BROWN

14.2900 12 cm 9x9

Alle gezeigten Koagulationspinzetten sind auch mit "2-Pin"-Stecker lieferbar. Bitte bestellen Sie die gewünschte Figur mit dem Zusatz "-2" (z.B. 14.3000-2)



All Coagulation Forceps are also available with "2-pin"-plug. Please order as follows: "14.3000-2" etc.

Toutes les pinces à coaguler sont également disponibles avec fiche <<2-pin>>. Merci d'ajouter <<-2>> au numéro d'article (par ex.: <<14.3000-2 >>)

Todas las pinzas para coagulación también son disponible con 2-pin clavija. Para un pedido encarge por ejemplo: "14.3000-2" etc.

Tutte le Pinze per Coagulazione sono disponibili anche nella versione con spina a due pin. Ordinare come segue: "14.3000-2", ecc.



COAGULATING

14.3000 11 cm/0,25 mm

14.3002 11 cm/0,6 mm



COAGULATING

14.3003 11 cm/0,25 mm

14.3005 11 cm/0,6 mm



COAGULATING

14.3007 11 cm/0,25 mm

14.3009 11 cm/0,6 mm

BIPOLARE KOAGULATIONSPINZETTEN
BIPOLAR COAGULATION FORCEPS
PINCES A COAGULATION BIPOLAIRE
PINZAS PARA COAGULACIÓN BIPOLAR
PINZE PER COAGULAZIONE BIPOLARE

PRO-MED

Alle gezeigten Koagulationspinzetten sind auch mit "2-Pin"-Stecker lieferbar. Bitte bestellen Sie die gewünschte Figur mit dem Zusatz "-2" (z.B. 14.3100-2)

All Coagulation Forceps are also available with "2-pin"-plug. Please order as follows: "14.3100-2" etc.

Toutes les pinces à coaguler sont également disponibles avec fiche <<2-pin>>. Merci d'ajouter <<2>> au numéro d'article (par ex.: <<14.3100-2>>)

Todas las pinzas para coagulación también son disponible con 2-pin clavija. Para un pedido encarge por ejemplo: "14.3100-2" etc.

Tutte le Pinze per Coagulazione sono disponibili anche nella versione con spina a due pin. Ordinare come segue: "14.3100-2", ecc.



COAGULATING

14.3100 15 cm/0,3 mm

14.3110 15 cm/1,0 mm

14.3120 15 cm/2,0 mm

COAGULATING

14.3102 18 cm/0,3 mm

14.3112 18 cm/1,0 mm

14.3122 18 cm/2,0 mm

COAGULATING

14.3104 20 cm/0,3 mm

14.3114 20 cm/1,0 mm

14.3124 18 cm/2,0 mm

COAGULATING

14.3106 22 cm/0,3 mm

14.3116 22 cm/1,0 mm

14.3126 22 cm/2,0 mm

COAGULATING

14.3108 24 cm/0,3 mm

14.3118 24 cm/1,0 mm

14.3128 24 cm/2,0 mm

Alle gezeigten Koagulationspinzetten sind auch mit "2-Pin"-Stecker lieferbar. Bitte bestellen Sie die gewünschte Figur mit dem Zusatz "-2" (z.B. 14.3141-2)

All Coagulation Forceps are also available with "2-pin"-plug. Please order as follows: "14.3141-2" etc.

Toutes les pinces à coaguler sont également disponibles avec fiche «<2-pin>».
Merci d'ajouter «<2>» au numéro d'article (par ex.: «<14.3141-2>»)

Todas las pinzas para coagulación también son disponible con 2-pin clavija. Para un pedido encarge por ejemplo: "14.3141-2" etc.

Tutte le Pinze per Coagulazione sono disponibili anche nella versione con spina a due pin. Ordinare come segue: "14.3141-2", ecc.



COAGULATING
14.3141 15 cm/0,3 mm
14.3151 15 cm/1,0 mm
14.3161 15 cm/2,0 mm

COAGULATING
14.3143 18 cm/0,3 mm
14.3153 18 cm/1,0 mm
14.3163 18 cm/2,0 mm

COAGULATING
14.3145 20 cm/0,3 mm
14.3155 20 cm/1,0 mm
14.3165 20 cm/2,0 mm

COAGULATING
14.3147 22 cm/0,3 mm
14.3157 22 cm/1,0 mm
14.3167 22 cm/2,0 mm

COAGULATING
14.3149 24 cm/0,3 mm
14.3159 24 cm/1,0 mm
14.3169 24 cm/2,0 mm

BIPOLARE KOAGULATIONSPINZETTEN
BIPOLAR COAGULATION FORCEPS
PINCES A COAGULATION BIPOLAIRE
PINZAS PARA COAGULACIÓN BIPOLAR
PINZE PER COAGULAZIONE BIPOLARE

PRO-MED

Alle gezeigten Koagulationspinzetten sind auch mit "2-Pin"-Stecker lieferbar. Bitte bestellen Sie die gewünschte Figur mit dem Zusatz "-2" (z.B. 14.3061-2)

All Coagulation Forceps are also available with "2-pin"-plug. Please order as follows: "14.3061-2" etc.

Toutes les pinces à coaguler sont également disponibles avec fiche <<2-pin>>. Merci d'ajouter <<2>> au numéro d'article (par ex.: <<14.3061-2 >>)

Todas las pinzas para coagulación también son disponibles con 2-pin clavija. Para un pedido encarga por ejemplo: "14.3061-2" etc.

Tutte le Pinze per Coagulazione sono disponibili anche nella versione con spina a due pin. Ordinare come segue: "14.361-2", ecc.



COAGULATING

14.3061 17 cm/0,3 mm

14.3071 17 cm/1,0 mm

14.3081 17 cm/2,0 mm



COAGULATING

14.3202 18 cm/0,3 mm

14.3212 18 cm/1,0 mm

14.3222 18 cm/2,0 mm



COAGULATING

14.3204 20 cm/0,3 mm

14.3214 20 cm/1,0 mm

14.3224 20 cm/2,0 mm

Alle gezeigten Koagulationspinzetten sind auch mit "2-Pin"-Stecker lieferbar. Bitte bestellen Sie die gewünschte Figur mit dem Zusatz "-2" (z.B. 14.3206-2)

All Coagulation Forceps are also available with "2-pin"-plug. Please order as follows: "14.3206-2" etc.

Toutes les pincers à coaguler sont également disponibles avec fiche <<2-pin>>. Merci d'ajouter <<-2>> au numéro d'article (par ex.: <<14.3206-2 >>)

Todas las pinzas para coagulación también son disponibles con 2-pin clavija. Para un pedido encarge por ejemplo: "14.3206-2" etc.

Tutte le Pinze per Coagulazione sono disponibili anche nella versione con spina a due pin. Ordinare come segue: "114.3206", ecc.



COAGULATING

14.3206 22 cm/0,3 mm

14.3216 22 cm/1,0 mm

14.3226 22 cm/2,0 mm



COAGULATING

14.3208 24 cm/0,3 mm

14.3218 24 cm/1,0 mm

14.3228 24 cm/2,0 mm

BIPOLAR-Kabel 3 m, f. Bipolpinzetten mit Flachstecker

Cables 3 mtr. for Forceps with flat plug
Cordons 3 mtr. pour pinces avec fiches plats
Cables 3 mtr. para pinzas con clavijas plano
Cavi 3 mtr. per pinze con spine piatto



14.3900

2-Bananenstecker
 2-banana-plug
 fiche 2-bananas
 clavija 2-bananas
 spina "2 banani"



14.3910

Model Erbe
 Model Erbe
 Modèle Erbe
 Modelo Erbe
 Modello Erbe



14.3920

Model Martin
 Model Martin
 Modèle Martin
 Modelo Martin
 Modello Martin



14.3930

Model Valleylab
 Model Valleylab
 Modèle Valleylab
 Modelo Valleylab
 Modello Valleylab



14.3940

Model Aesculap GK50
 Model Aesculap GK50
 Modèle Aesculap GK50
 Modelo Aesculap GK50
 Modello Aesculap GK50



14.3950

Model Codman CMC II
 Model Codman CMC II
 Modèle Codman CMC II
 Modelo Codman CMC II
 Modello Codman CMC II



BIPOLAR-Kabel 3 m, f. Bipolpinzetten mit "2-Pin"-Stecker

Cables 3 mtr. for Forceps with "2-pin"-plug
Cordons 3 mtr. pour pinces avec fiches <<2-pin>>
Cables 3 mtr. para pinzas con 2-pin clavija
Cavi 3 mtr. per pinze con spina a due pin



14.3905

2-Bananenstecker
 2-banana-plug
 fiche 2-bananas
 clavija 2-bananas
 spina "2 banani"

14.3915

Model Erbe
 Model Erbe
 Modèle Erbe
 Modelo Erbe
 Modello Erbe

14.3925

Model Martin
 Model Martin
 Modèle Martin
 Modelo Martin
 Modello Martin

14.3935

Model Valleylab
 Model Valleylab
 Modèle Valleylab
 Modelo Valleylab
 Modello Valleylab

14.3945

Model Aesculap GK50
 Model Aesculap GK50
 Modèle Aesculap GK50
 Modelo Aesculap GK50
 Modello Aesculap GK50

14.3955

Model Codman CMC II
 Model Codman CMC II
 Modèle Codman CMC II
 Modelo Codman CMC II
 Modello Codman CMC II



LONDON-COLLEGE

- 14.6001 #1
- 14.6002 #2
- 14.6003 #3
- 14.6004 #4
- 14.6005 #5
- 14.6006 #6

LONDON-COLLEGE

- 14.6011 #1
- 14.6012 #2
- 14.6013 #3
- 14.6014 #4
- 14.6015 #5
- 14.6016 #6

LONDON-COLLEGE

- 14.6031 #1
- 14.6032 #2
- 14.6033 #3
- 14.6034 #4
- 14.6035 #5
- 14.6036 #6

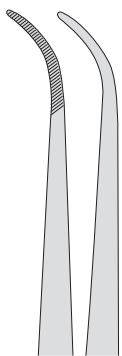

1

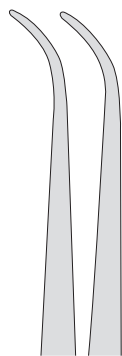

2



3

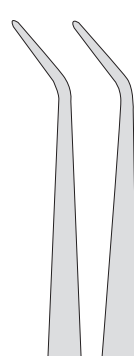

4

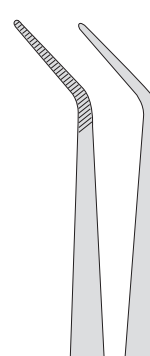

5

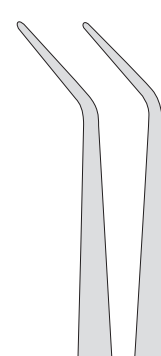

6



MERIAM

- 14.6201 16 cm #1
- 14.6202 16 cm #2
- 14.6203 16 cm #3
- 14.6204 16 cm #4
- 14.6205 16 dm #5
- 14.6206 16 cm #6

MERIAM

- 14.6211 16 cm #1
- 14.6212 16 cm #2
- 14.6213 16 cm #3
- 14.6214 16 cm #4
- 14.6215 16 cm #5
- 14.6216 16 cm #6

FLAGG

- 14.6251 16 cm #1
- 14.6252 16 cm #2
- 14.6253 16 cm #3
- 14.6254 16 cm #4

FLAGG

- 14.6261 16 cm #1
- 14.6262 16 cm #2
- 14.6263 16 cm #3
- 14.6264 16 cm #4

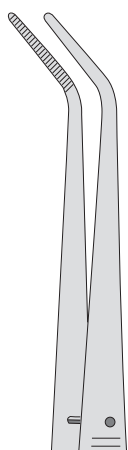

1

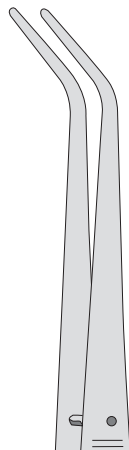

2

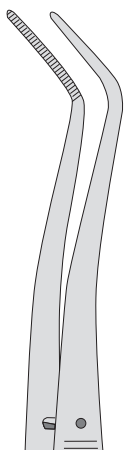

3

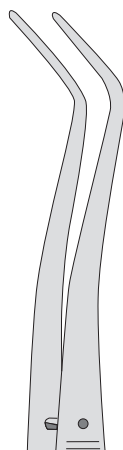

4

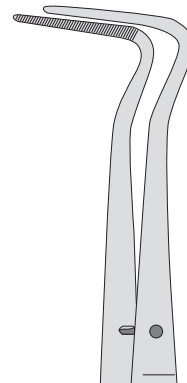

5

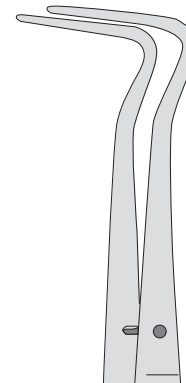

6

Hypophysenpinzetten
 Hypophyseal forceps
 Pinces à hypophyse
 Pinzas para hipofisis
 Pize per ipofisi



ADSON
 27.2500 18,5 cm



HOEN
 20cm

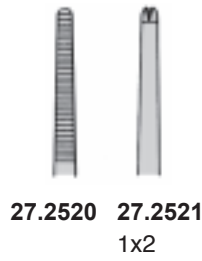

27.2520 27.2521
 1x2



ADSON
 27.2540 23 cm



ADSON
 27.2541 23 cm



ADSON
 27.2542 23 cm



SCOVILLE
 22 cm



27.2560
 10 mm



27.2562
 13 mm



JACOBSEN-MICRO
28.0011 11 cm
28.0015 15 cm
28.0018 18 cm



JACOBSEN-ADSON
28.0030 12 cm



JACOBSEN-ADSON
28.0032 15 cm



28.0080



28.0081

12 cm / 8 mm



28.0082



28.0083

15 cm / 8 mm

Mikro-Knüpfpinzetten
Micro Suture Forceps
Micro Pincès à sutures
Micro pinzas para suturas
Micro-pinze per ligature



18 cm / 8 mm



28.0084



28.0085



21 cm / 8 mm



28.0086



28.0087

Tumor- und Gewebefäßpinzetten
Tumor- and Tissue Grasping Forceps
Pinces pour saisir tumeurs et tissus
Pinzas para coger tejidos y tomores
Pinze per afferare tessuti e tumori



HUNT
20 cm

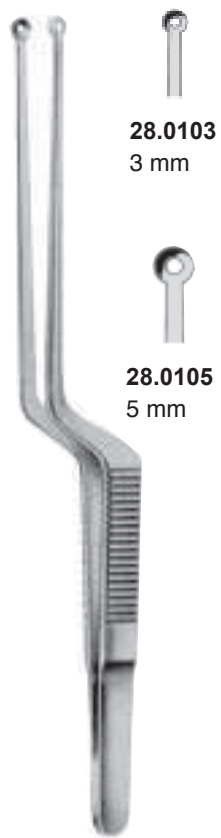

YASARGIL
22 cm

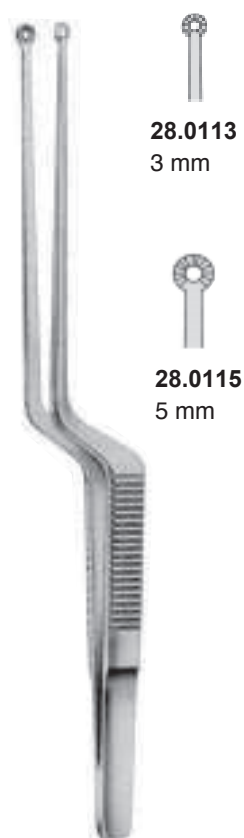

YASARGIL
22 cm

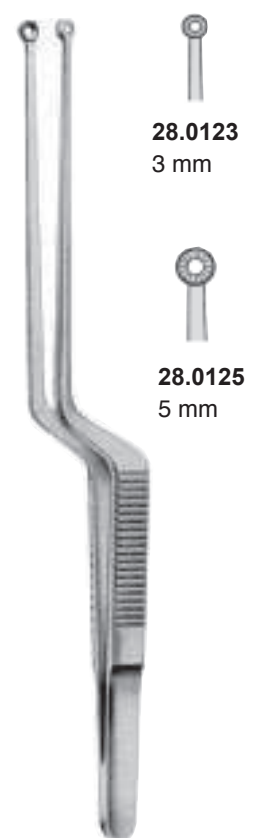

HEIFETZ
22 cm



Diamantbeschichtete Spitzen
 Diamond coated tips
 Avec bouts de diamant
 Puntas con cascós de diamante
 con punte diamantate

TITANIUM



spitz
 sharp
 pointu
 agudo
 appuntato



stumpf
 blunt
 mousse
 romo
 smusso

28.0130 18.5 cm
28.0136 22.5 cm

28.0132 18.5 cm
28.0138 22.5 cm

Mikro-Nahtpinzetten mit Gegengewicht und diamantbeschichteten Spitzen
 Micro-Suturing Forceps counterbalanced with diamond coated tips
 Micro pincés à suture avec contrepoides, bouts de diamant
 Micro pinzas para sutura con contrapeso, puntas con cascós de diamante
 Micro-pinze per sutura con contrappeso, punte diamantate

RHOTON-"BALANCE"



6 x 0,4mm



18 cm
 21 cm

28.0362SD
28.0364SD

28.0363SD
28.0365SD

6 x 0,8mm



18 cm
 21 cm

28.0372SD
28.0374SD

28.0373SD
28.0375SD

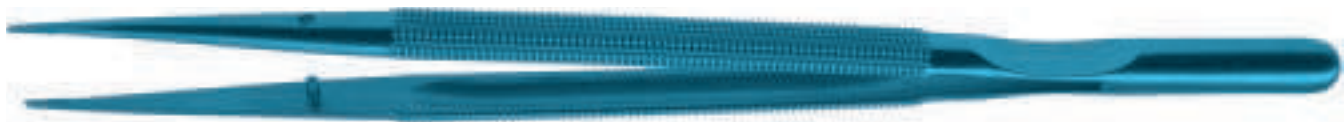

6 x 0,4mm

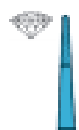

18 cm
 21 cm

28.0362T
28.0364T

28.0363T
28.0365T

TITANIUM

TITANIUM

6 x 0,8 mm



18 cm
 21 cm

28.0372T
28.0374T

28.0373T
28.0375T

TITANIUM

TITANIUM

TITANIUM

RHOTON



Diamantbeschichtete Spitzen
Diamond coated tips
Avec bouts de diamant
Puntas con cascós de diamante
con punte diamantate



0,4mm

15 cm
18 cm
21 cm
23 cm

28.0220SD
28.0222SD
28.0224SD
28.0226SD



28.0221SD
28.0223SD
28.0225SD
28.0227SD



0,8mm

15 cm
18 cm
21 cm
23 cm

28.0230SD
28.0232SD
28.0234SD
28.0236SD



28.0231SD
28.0233SD
28.0235SD
28.0237SD

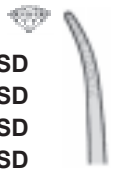

0,4mm

15 cm
18 cm
21 cm
23 cm

28.0220T
28.0222T
28.0224T
28.0226T



28.0221T
28.0223T
28.0225T
28.0227T



TITANIUM

TITANIUM

0,8mm

15 cm
18 cm
21 cm
23 cm

28.0230T
28.0232T
28.0234T
28.0236T



28.0231T
28.0233T
28.0235T
28.0237T

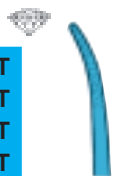

TITANIUM

TITANIUM

RHOTON-"BALANCE"

Mikropinzetten mit Gegengewicht und diamantbeschichteten Spitzen
Micro-Forceps counterbalanced with diamond coated tips
Micro pincés avec contrepoids, bouts de diamant
Micro pinzas para con contrapeso, puntas con cascós de diamante
Micro-pinze con contrapeso, punte diamantate



0,4mm

18 cm
21 cm

28.0382SD
28.0384SD



28.0383SD
28.0385SD



0,8mm

18 cm
21 cm

28.0392SD
28.0394SD



28.0393SD
28.0395SD

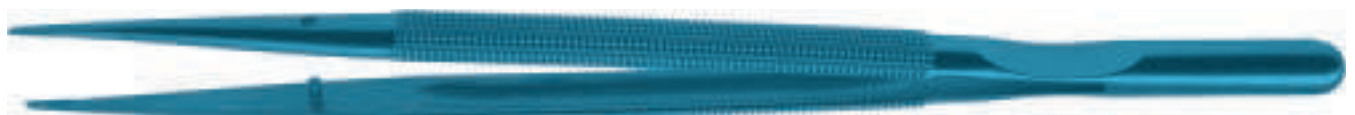

0,4mm

18 cm
21 cm

28.0382T
28.0384T



28.0383T
28.0385T



TITANIUM

TITANIUM

0,8mm

18 cm
21 cm

28.0392T
28.0394T



28.0393T
28.0395T



TITANIUM

TITANIUM









TITANIUM











Diamantbeschichtete Spitzen
 Diamond coated tips
 Avec bouts de diamant
 Puntas con cascotes de diamante
 con punte diamantate

RHOTON

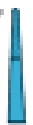

					
6 x 0,4mm			6 x 0,8 mm		
15 cm	28.0260SD	28.0261SD	15 cm	28.0270SD	28.0271SD
18 cm	28.0262SD	28.0263SD	18 cm	28.0272SD	28.0273SD
21 cm	28.0264SD	28.0265SD	21 cm	28.0274SD	28.0275SD
23 cm	28.0266SD	28.0267SD	23 cm	28.0276SD	28.0277SD



					
6 x 0,4mm			6 x 0,8 mm		
15 cm	28.0260T	28.0261T	15 cm	28.0270T	28.0271T
18 cm	28.0262T	28.0263T	18 cm	28.0272T	28.0273T
21 cm	28.0264T	28.0265T	21 cm	28.0274T	28.0275T
23 cm	28.0266T	28.0267T	23 cm	28.0276T	28.0277T

TITANIUM

TITANIUM

TITANIUM

TITANIUM

TITANIUM



Diamantbeschichtete Spitzen
Diamond coated tips
Avec bouts de diamant
Puntas con cascos de diamante
con punte diamantate

RHOTON



6 x 0,4mm			6 x 0,8 mm		
15 cm	28.0280SD	28.0281SD	15 cm	28.0290SD	28.0291SD
18 cm	28.0282SD	28.0283SD	18 cm	28.0292SD	28.0293SD
21 cm	28.0284SD	28.0285SD	21 cm	28.0294SD	28.0295SD
23 cm	28.0286SD	28.0287SD	23 cm	28.0296SD	28.0297SD



6 x 0,4mm			6 x 0,8 mm		
15 cm	28.0280T	28.0281T	15 cm	28.0290T	28.0291T
18 cm	28.0282T	28.0283T	18 cm	28.0292T	28.0293T
21 cm	28.0284T	28.0285T	21 cm	28.0294T	28.0295T
23 cm	28.0286T	28.0287T	23 cm	28.0296T	28.0297T
	TITANIUM	TITANIUM		TITANIUM	TITANIUM

TITANIUM



Diamantbeschichtete Spitzen
 Diamond coated tips
 Avec bouts de diamant
 Puntas con cascos de diamante
 con punte diamantate



RHOTON

1 x 0,5mm

15 cm
 18 cm
 21 cm
 23 cm

TITANIUM

28.0240T
28.0242T
28.0244T
28.0246T



28.0240SD
28.0242SD
28.0244SD
28.0246SD



2 x 1,0 mm

15 cm
 18 cm
 21 cm
 23 cm

TITANIUM

28.0250T
28.0252T
28.0254T
28.0256T



28.0250SD
28.0252SD
28.0254SD
28.0256SD

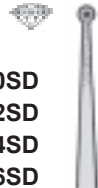

Mikro-Ringpinzetten mit Gegengewicht und diamantbeschichteten Spitzen
 Micro Ring Forceps counterbalanced with diamond coated tips
 Micro pincés à anneau avec contrepoids, bouts de diamant
 Micro pinzas con ojal y contrapeso, puntas con cascos de diamante
 Micro-pinze con anello e contrappeso, punte diamantate



RHOTON

1 x 0,5mm

18 cm
 21 cm

TITANIUM

28.0342T
28.0344T



28.0342SD
28.0344SD



2 x 1,0 mm

18 cm
 21 cm

TITANIUM

28.0352T
28.0354T



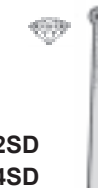

28.0352SD
28.0354SD





TITANIUM



DEBAKEY

		
1,2 mm		
15 cm	28.0320T	28.0320S
18 cm	28.0322T	28.0322S
21 cm	28.0324T	28.0324S
23 cm	28.0326T	28.0326S
	TITANIUM	

		
1,8 mm		
15 cm	28.0330T	28.0330S
18 cm	28.0332T	28.0332S
21 cm	28.0334T	28.0334S
23 cm	28.0336T	28.0336S
	TITANIUM	



28.0600 16 cm
28.0602 18 cm
28.0604 20 cm
28.0606 22 cm
28.0608 24 cm

Spitzen 0,6 mm
 Tips 0,6 mm
 bout 0,6 mm
 punta 0,6 mm
 punte 0,6 mm



28.0610 16 cm
28.0612 18 cm
28.0614 20 cm
28.0616 22 cm
28.0618 24 cm

Spitzen 0,9 mm
 Tips 0,9 mm
 bout 0,9 mm
 punta 0,9 mm
 punte 0,9 mm



28.0622 18 cm

1 x 2 Zähne
 1 x 2 teeth
 1 x 2 dents
 1 x 2 dientes
 1 x 2 denti



Ø 3 mm



YASARGIL
YASARGIL-SAMII
28.0710 22 cm
28.0700 24 cm

Ø 5 mm



YASARGIL
YASARGIL-SAMII
28.0712 22 cm
28.0702 24 cm

Ø 7 mm



YASARGIL-SAMII
28.0704 24 cm

löffelförmig
spoon-shaped
en forme de cuillère
forma cuchara
forma di cucchiaio

Ø 3 mm



YASARGIL
28.0714 22 cm
gezahnt/serrated/
dentelés/dentada/dentate

Ø 3 mm



HEIFETZ
28.0715 22 cm
gezahnt/serrated/
dentelés/dentada/dentate

Ø 5 mm



HEIFETZ
28.0717 22 cm
kürettenförmig gezahnt
curette-shaped serrated
en forme de curette dentelés
forma cureta dentada
forma di cucchiaio dentate

Ø 5 mm



YASARGIL
28.0716 22 cm
flach, gezahnt
flat, serrated
mors plats, dentelés
boca plana, dentada
morsi piatti, dentate



SAMII
23 cm

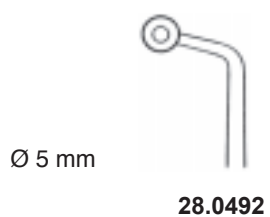
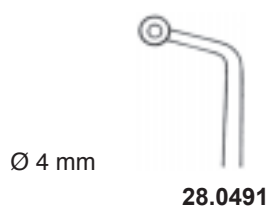
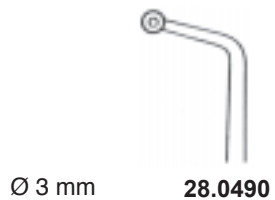

löffelförmig
spoon-shaped
en forme de cuillère
forma cuchara
forma di cucchiaino



TROELTSCH
32.0640
11 cm



TROELTSCH
32.0642
13 cm



WILDE
32.0650
14 cm



LUCAE
32.0660
14 cm



LUCAE
32.0662
16 cm

Columnella-Pinzette
 Columnella Forceps
 Pnce pour columelle
 Pinza para columela
 Pinza per columella



COTTLE
33.0440
 15 cm



COTTLE
33.0446
 11 cm



TROELTSCH
33.0450
 15 cm



TROELTSCH
33.0452
 18 cm



GRUENWALD
33.0460 16 cm
33.0462 20 cm

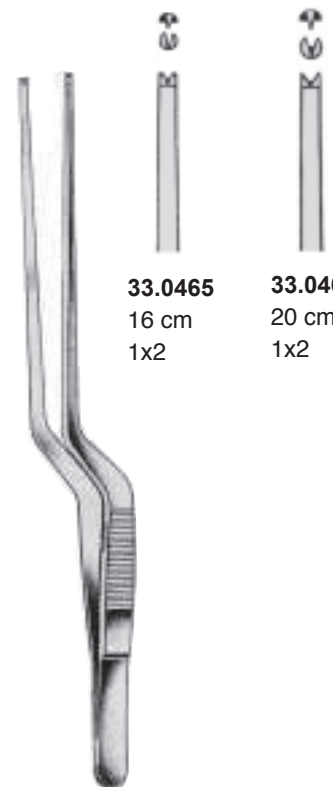

33.0465
 16 cm
 1x2

33.0467
 20 cm
 1x2

GRUENWALD

OPHTHALMOLOGIE • OPHTHALMOLOGY • OFTALMOLOGIA • OPHTHALMOLOGIE • OFTALMOLOGIA

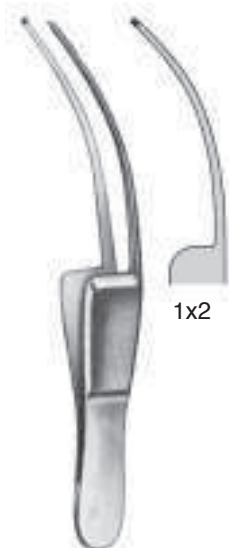

FISHER-ARLT
30.2020
7 cm



GRAEFE
30.2050
7 cm/0,7 mm



GRAEFE
30.2051
7 cm/0,7 mm



GRAEFE
30.2056
7 cm/0,7 mm



GRAEFE
30.2057
7 cm/0,7 mm



STEVENS
30.2062
10 cm



STEVENS
30.2063
10 cm



STEVENS
30.2065
10 cm



STEVENS
30.2066
10 cm



STEVENS
30.2067
10 cm



STEVENS
30.2069
10 cm



FOERSTER
30.2070
8,5 cm/0,8 mm



FOERSTER
30.2071
8,5 cm/0,8 mm



FOERSTER
30.2076
8,5 cm



FOERSTER
30.2077
8,5 cm



BISHOP-HARMAN
30.2080
0,8 mm



BISHOP-HARMAN
30.2082
0,5 mm



BISHOP-HARMAN
30.2086
0,8 mm



BISHOP-HARMAN
30.2088
0,5 mm

OPHTHALMOLOGIE • OPHTHALMOLOGY • OFTALMOLOGIA • OPHTHALMOLOGIE • OFTALMOLOGIA



BONN
30.2090
7 cm / 1x2

mit Führungsstift
with guide pin
avec guide
con guía
con guida



BONN
30.2091
7 cm / 1x2

ohne Führungsstift
without guide pin
sans guide
sin guía
senza guida



BONN
30.2094
10 cm / 1x2



GILL
30.2111
7,5 cm / 1x2



GILL
30.2137
7,5 cm / 1x2

Zähne unten
teeth below
dents en bas
dientes abajo
denti in basso



GILL
30.2138
7,5 cm / 1x2

Zähne seitwärts
lateral teeth
dents latérales
dientes laterales
denti laterali

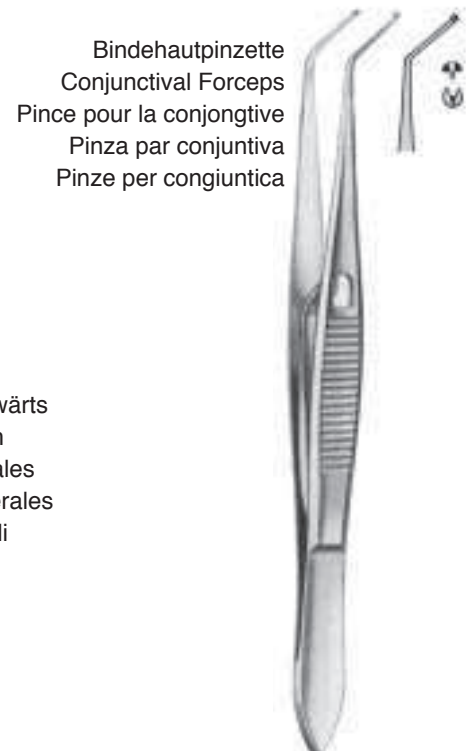

O'CONNOR
30.2170
10 cm / 1x2

Bindehautpinzette
Conjunctival Forceps
Pince pour la conjongtive
Pinza par conjuntiva
Pinze per congiuntica

OPHTHALMOLOGIE • OPHTHALMOLOGY • OFTALMOLOGIA • OPHTHALMOLOGIE • OFTALMOLOGIA



HESS
30.2140
7 cm / 1x2



HESS
30.2141
7 cm / 1x2



**BARRAQUER-
KATZIN**
30.2150
7 cm / 1x2



**BARRAQUER-
COLIBRI**
30.2152
7 cm / 1x2



TROUTMAN
30.2154
7 cm / 1x2



BARRAQUER
30.2156
7 cm / 1x2



BARRAQUER
30.2158
7 cm / 1x2

OPHTHALMOLOGIE • OPHTHALMOLOGY • OFTALMOLOGIA • OPHTHALMOLOGIE • OFTALMOLOGIA



DERMOT-PIERCE
30.2120
8 cm



DERMOT-PIERCE
30.2121
8 cm



DERMOT-PIERCE
30.2122
8 cm



DERMOT-PIERCE
30.2125
8 cm



DERMOT-PIERCE
30.2126
8 cm



DERMOT-PIERCE
30.2127
8 cm



DERMOT-PIERCE
30.2129
8 cm

OPHTHALMOLOGIE • OPHTHALMOLOGY • OFTALMOLOGIA • OPHTHALMOLOGIE • OFTALMOLOGIA



GRAEFE



30.2300

11 cm

ohne Schloß

without lock

sans verrou

sin cremallera

senza cremagliera



30.2302

11 cm

mit Schloß

with lock

avec verrou

con cremallera

con cremagliera



GREEN

10 cm



30.2310

5 mm

ohne Schloß/without lock/sans verrou/
sin cremallera/senza cremagliera



30.2314

10 mm



30.2312

5 mm

mit Schloß/with lock/avec verrou/
con cremallera/con cremagliera



30.2316

10 mm



BARRAQUER

30.2320

10 cm



ELSCHINIG

30.2330

11 cm



LESTER



30.2350

9 cm / 1x2



30.2352

9 cm / 2x3

OPHTHALMOLOGIE • OPHTHALMOLOGY • OFTALMOLOGIA • OPHTHALMOLOGIE • OFTALMOLOGIA



CASTROVIEJO
30.2380
9 cm / 1x1



CASTROVIEJO
30.2381
9 cm / 1x1



CASTROVIEJO
30.2382
9 cm / 2x2



CASTROVIEJO
30.2383
9 cm / 2x2



EPISKLERAL
30.2390
10 cm

OPHTHALMOLOGIE • OPHTHALMOLOGY • OFTALMOLOGIA • OPHTHALMOLOGIE • OFTALMOLOGIA

TITANIUM



CASTROVIEJO

- 30.2510 10 cm / 0,12 mm
- 30.2512 10 cm / 0,30 mm
- 30.2514 10 cm / 0,50 mm
- 30.2516 10 cm / 1,00 mm
- 30.2518 10 cm / 1,50 mm



CASTROVIEJO

- 30.2515 10 cm / 0,50 mm
- 30.2517 10 cm / 1,00 mm
- 30.2519 10 cm / 1,50 mm



PAUFIQUE

- 30.2520 8,5 cm



PAUFIQUE

- 30.2522 8,5 cm/1x2
- 30.2522T 8,5 cm/1x2



ST.MARTIN

- 30.2530 7 cm



TUEBINGEN

- 30.2540 10 cm



TUEBINGEN

- 30.2542 10 cm



TUEBINGEN

- 30.2543 10 cm



BONN

- 30.2548 10 cm / 1x2

OPHTHALMOLOGIE • OPHTHALMOLOGY • OFTALMOLOGIA • OPHTHALMOLOGIE • OFTALMOLOGIA



McPHERSON
30.2550
8,5 cm



McPHERSON
30.2551
8,5 cm



McPHERSON
30.2554
8,5 cm / 1x2



McPHERSON
30.2555
8,5 cm / 1x2



McPHERSON
30.2560
10 cm



McPHERSON
30.2563
10 cm / 1x2



KELMAN-McPHERSON
30.2570
10 cm



BARRAQUER
30.2575
7 cm

OPHTHALMOLOGIE • OPHTHALMOLOGY • OFTALMOLOGIA • OPHTHALMOLOGIE • OFTALMOLOGIA



MOORFIELD
30.2650
10,5 cm



SCHWEIGGER
30.2687
10 cm



SCHWEIGGER
30.2689
10 cm



BONACCOLTO
30.2725
11 cm

OPHTHALMOLOGIE • OPHTHALMOLOGY • OFTALMOLOGIA • OPHTHALMOLOGIE • OFTALMOLOGIA



ARRUGA
30.2600
10 cm



ARRUGA
30.2602
10 cm



KALT
30.2610
10 cm



CASTROVIEJO
30.2615
10 cm



ELSCHNIG
30.2630
10 cm



TERSON
30.2660
9 cm



FUCHS
30.2682
7 cm



HESS
30.2684
6 cm



HESS
30.2685
6,5 cm

OPHTHALMOLOGIE • OPHTHALMOLOGY • OFTALMOLOGIA • OPHTHALMOLOGIE • OFTALMOLOGIA

Muskelpinzette
Muscular Forceps
Pince musculaire
Pinza muscular
Pinza per muscolo



McCOLLOUGH
30.2700
9,5 cm



McCOLLOUGH
30.2702
9,5 cm / 1x2



TROUTMAN-RECTUS
30.2705
8,5 cm / 1x2

Vorderkammer-Pinzetten / Anterior Chamber Forceps / Pinces pour la chambre antérieure /
Pinzas para la cámara anterior / Pinze per camera anteriore



BARRAQUER
30.2707
5,5 cm



BARRAQUER
30.2708
5,5 cm



BARRAQUER
30.2709
5,5 cm

OPHTHALMOLOGIE • OPHTHALMOLOGY • OFTALMOLOGIA • OPHTHALMOLOGIE • OFTALMOLOGIA



BONACCOLTO
30.2720
10 cm



BONACCOLTO
30.2722
10 cm



ALABAMA
30.2730
9,5 cm



NUGENT
10 cm



30.2740



30.2742



DASTOOR
30.2744
11 cm



DASTOOR
30.2746
11 cm / 1x2



DASTOOR
30.2748
11 cm / 2x3

OPHTHALMOLOGIE • OPHTHALMOLOGY • OFTALMOLOGIA • OPHTHALMOLOGIE • OFTALMOLOGIA



JAMESON
10 cm



30.2960 **30.2961**
 links rechts
 left right
 à gauche à droite
 izquierda derecha
 sinistra destra



JAMESON
10 cm

Trachompinzette
 Trachona Forceps
 Pince pour le trachome
 Pinza para tracoma
 Pinza per tracoma



KNAPP
30.2900
11 cm



ERHARDT
30.2920 9 cm



links
 left
 à gauche
 izquierda
 sinistra

SNELLEN
30.2930 10 cm



rechts
 right
 à droite
 derecha
 destra

SNELLEN
30.2931 10 cm

OPHTHALMOLOGIE • OPHTHALMOLOGY • OFTALMOLOGIA • OPHTHALMOLOGIE • OFTALMOLOGIA



PRINCE



30.2950 links
 left
 à gauche
 izquierda
 sinistra

30.2951 rechts
 right
 à droite
 derecha
 destra



PRINCE



BERKE



30.2970
 20 mm



30.2977
 27 mm



BERENS
30.2980 9 cm



BLASCOVICS
 10 cm



30.2990 links
 left
 à gauche
 izquierda
 sinistra

30.2991 rechts
 right
 à droite
 derecha
 destra



BLASCOVICS
 10 cm

OPHTHALMOLOGIE • OPHTHALMOLOGY • OFTALMOLOGIA • OPHTHALMOLOGIE • OFTALMOLOGIA



DESMARRES
9 cm



30.3000
20 mm



30.3001
26 mm



30.3002
32 mm



AYER
30.3014
9 cm



AYER
30.3015
9 cm



LAMBERT
30.3020
9 cm

OPHTHALMOLOGIE • OPHTHALMOLOGY • OFTALMOLOGIA • OPHTHALMOLOGIE • OFTALMOLOGIA



LORDAN
30.3030
9 cm



HEATH (Hunt)
30.3050
9,5 cm