

geriefte Valven
Serrated blades
valves striées
valvas estriadas



COX
17.5210
12 cm

für Finger und Zehen
Finger- and Toe Retractor
pour doigts et orteils
para dedos

Bleihände
Lead hands
Mains opératoire de plomb
Manos de plomo

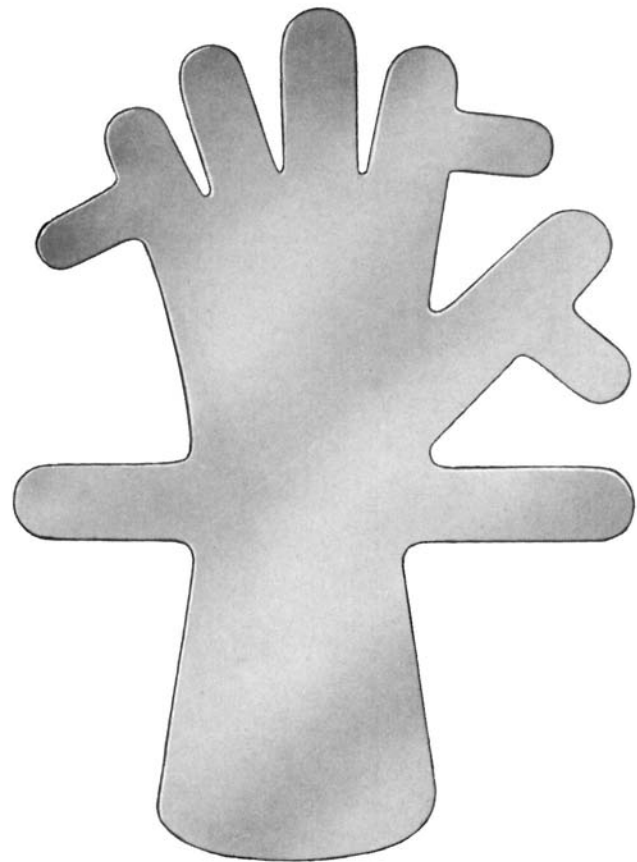

23.3290
Kinder
Child
Enfant
Ninos

23.3292
Erwachsene
Adult
Adulte
Adultos

Nagelbohrer komplett
 Nail Drill complete
 Perceuse à ongles, complète
 Taladro para uñas, completo



58.0309
 1 Satz Einzelbohrer
 Set of 3 drill points
 Jeu de 3 vrilles
 Juego de 3 trepanos

58.0300
 mit 3 Bohrern
 with 3 drill points
 avec 3 vrilles
 con 3 trepanos

Nagelausreißzange
 Nail Extracting Forceps
 Pince à extraction des ongles
 Pinza arranca-uñas

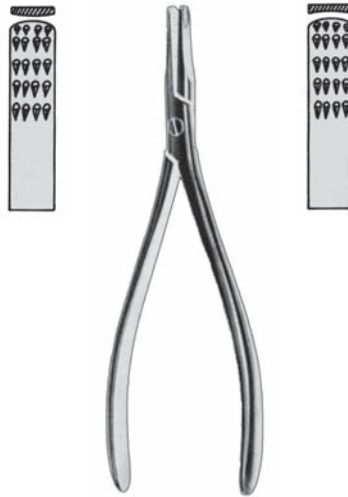

RADOLF
58.0320
 14 cm

Nagelspaltzange
 Nail Splitting Forceps
 Pince à ongles
 Pinza corta-uñas



ANVIL
58.0517
 14 cm

Fingerringsägen
 Finger Ring Saws
 Scies pour bagues
 Sierras para anillos



WALTON
58.0350
 16 cm



58.0360
 17 cm

Nagelspaltzschere
 Nail Splitting Scissors
 Ciseaux à fendre les ongles
 Tijera para hender las uñas

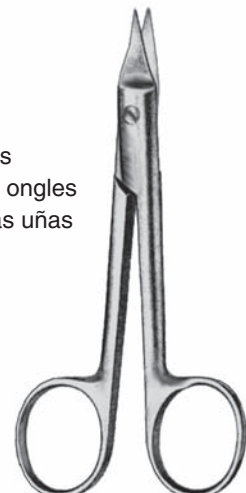

SYSTRUNK
58.0625
 13 cm

Sehnenfassinstrumente
 Tendon Seizing Instruments
 Pinces pour saisir les tendons
 Pinzas para coger tendones



CARROL
 23.3201 11 cm



BRAND

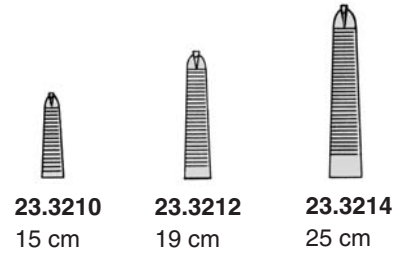

KLEINERT-KUTZ
 23.3216 20 cm



LARSEN
 10 cm

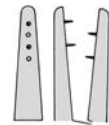
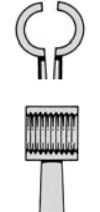
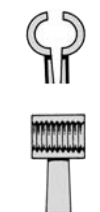
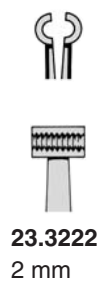

STEINMANN
 23.3230 13 cm

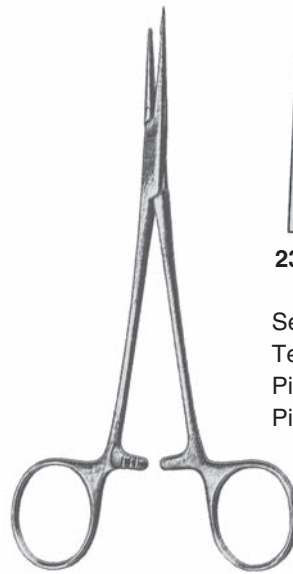

15 cm

23.3232

23.3233

Sehnenflechklemmen
Tendon Interlacing Forceps
Pincés pour entrelacer les tendons
Pinzas para entrelazar tendones

Sehenschäler
Tendon Stripper
Strippers à tendons
Mondador de tendones

Sehnenführer
Tendon Guide
Conducteur à tendons
Conductor de tendones



BUNNELL

23.3242
2 mm

23.3243
3 mm

23.3244
4 mm

23.3245
5 mm

23.3246
6 mm

23.3247
7 mm



BUNNELL
23.3250 23 cm

Extensionsbügel für Finger zur
Verwendung mit KIRSCHNER Drähten

Traction bows for fingers for use with
KIRSCHNER wires

Etriers de traction pour doigts avec
broches de KIRSCHNER

estribos para extensión de dedos para
agujas de KIRSCHNER

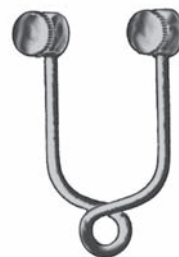

SCHWARZ
23.3260 60 mm
23.3262 75 mm



SCHWARZ
23.3264 160 mm

Wund- und Meniskushaken
Retractors for knee
Ecarteurs pour genou
Separadores para rodilla



SMILLIE
14 cm

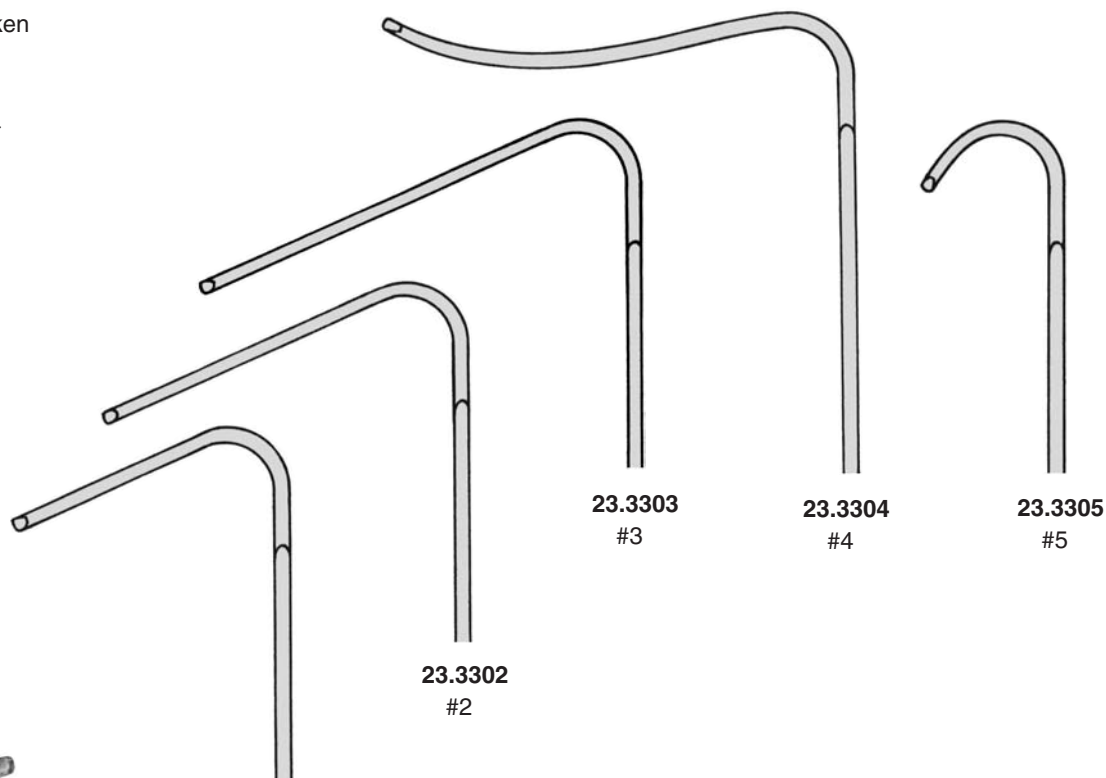

23.3301
#1

23.3302
#2

23.3303
#3

23.3304
#4

23.3305
#5



BLOUNT
23.3310 18 cm



23.3312
21 cm

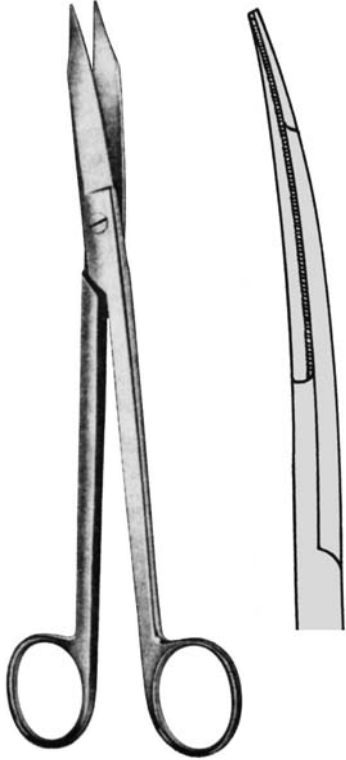

MARTIN
23.3320 20 cm

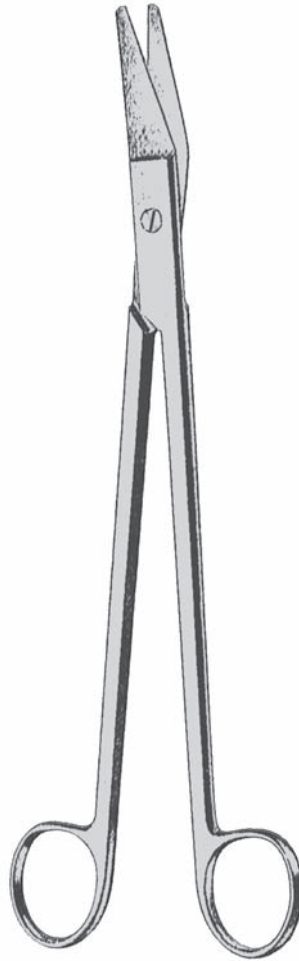

RESANO
23.3325 25 cm

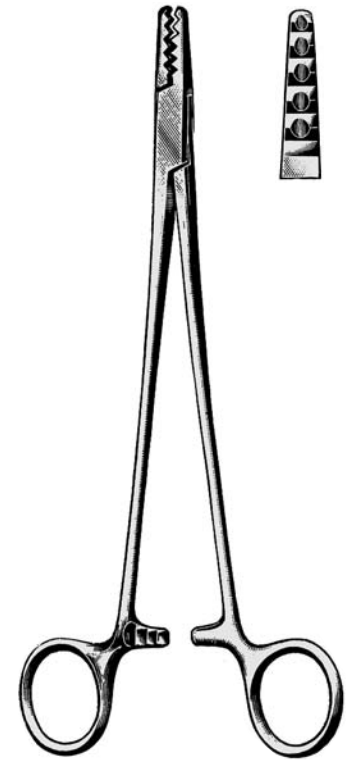

MARTIN
23.3354 20 cm

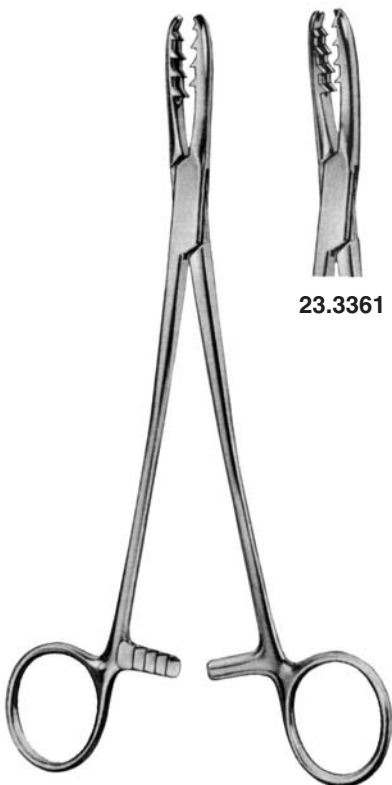

BIRCHER-GANSKE
23.3360 20 cm



BIRCHER-GANSKE
23.3363 20 cm

Meniskotome
 Meniscotomy Knives
 Meniscotomes
 Bisturios para meniscos



LOWE-BRECK
 23.3380 25 cm

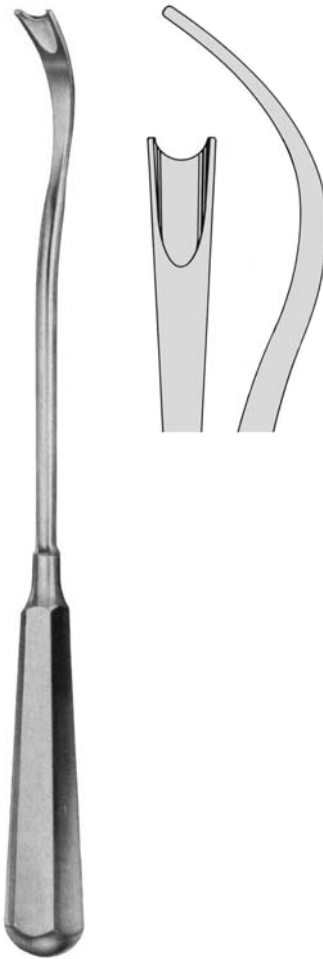

DOWNING
 23.3381 25 cm

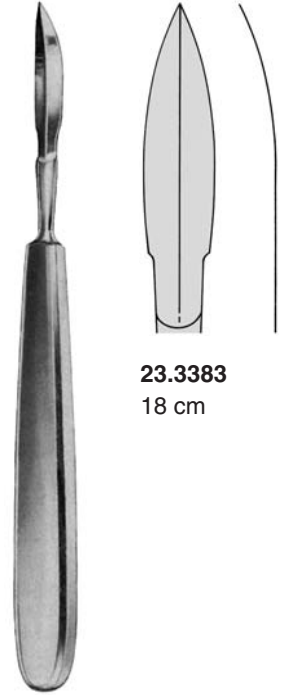

23.3383
 18 cm



SMILLIE
 17 cm



23.3396



23.3397



23.3398



NEFF
 22 cm



23.3400



23.3402



SALNIUS
23.3410
22 cm



SALNIUS
23.3412
22 cm

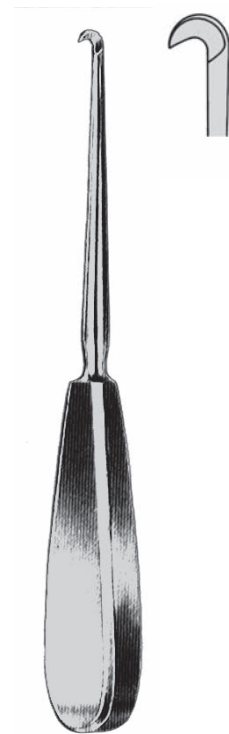

BIRCHER
23.3421
20 cm

Knochendraht, in Ringen à 10 m, weich
 Bone wire, in coils of 10 mtr. (33 ft.), soft
 Fil à cerclage, souple, en rouleaux de 10 m
 Hilo para huesos, blando, en rollos de 10 m



- 23.4002 10 m / 0,2 mm
- 23.4003 10 m / 0,3 mm
- 23.4004 10 m / 0,4 mm
- 23.4005 10 m / 0,5 mm
- 23.4006 10 m / 0,6 mm
- 23.4007 10 m / 0,7 mm
- 23.4008 10 m / 0,8 mm
- 23.4009 10 m / 0,9 mm
- 23.4010 10 m / 1,0 mm
- 23.4012 10 m / 1,2 mm
- 23.4015 10 m / 1,5 mm



LOUTE
 23.4050 21 cm

Drahtspanner
 Wire-Tighteners
 Tendeurs serre-fil
 Tensores sierra-hilo

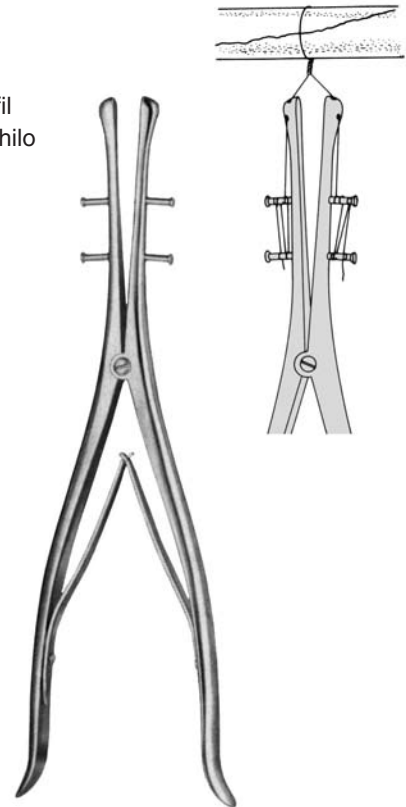

DEMEL
 23.4060 28 cm

Drahtumführungsadeln – Wire Guides – Aiguilles passe-fils – Agujas passa-hilos



DEMEL
 28 cm

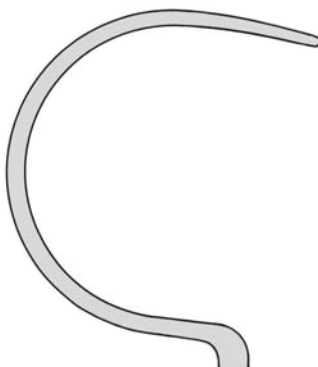

23.4070
 #1

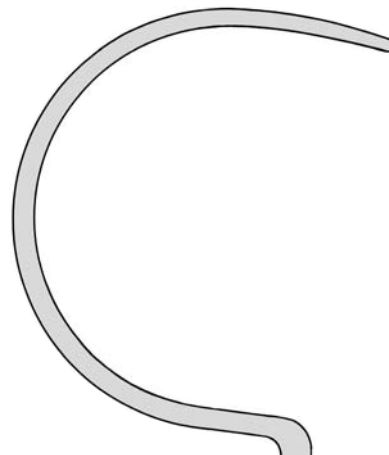

23.4072
 #2

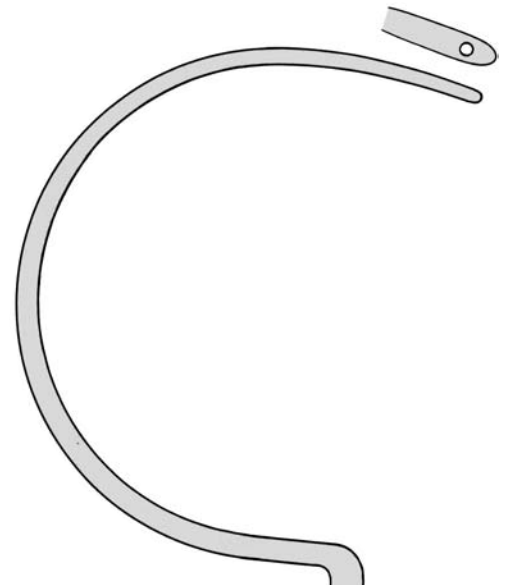

23.4074
 #3

Drahtumföhrungsnadeln / Wire Guides / Aiguilles passe-fils / Agujas passa-hilos

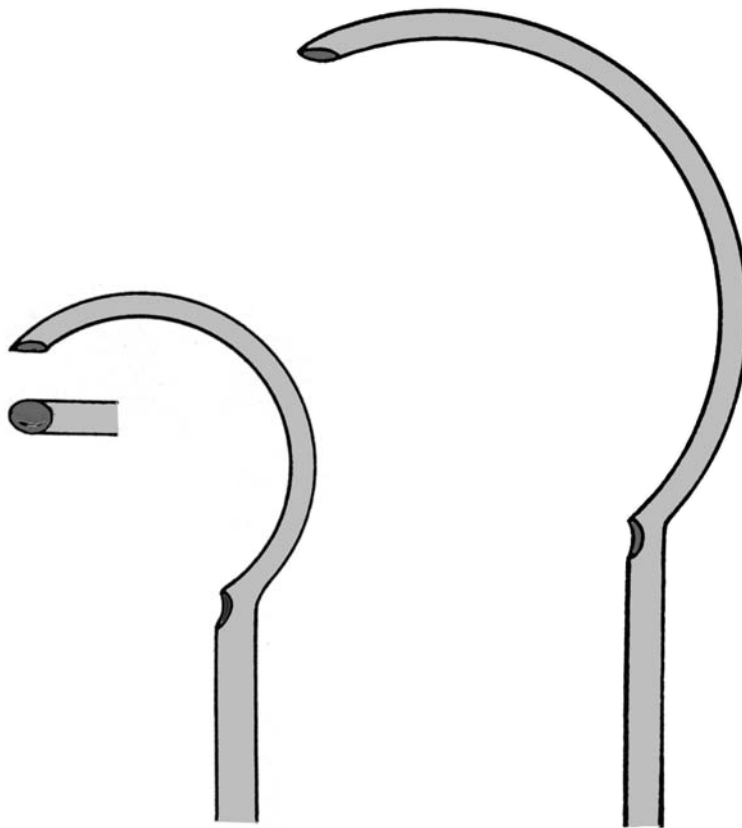

23.4080
24 cm

23.4082
27 cm



23.4085
22 cm

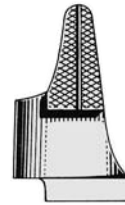

23.4130 14,5 cm
PROME(DUR)



23.4135 14,5 cm



23.4150 14 cm



DIAMOND
23.4160 16 cm
PROME(DUR)

für harten Draht bis Ø
 hard wire up to Ø
 fils durs jusqu'à Ø
 para duros hasta Ø

1,0

1,0

1,0

für weichen Draht bis Ø
 soft wire up to Ø
 fils moux jusqu'à Ø
 para blandos hasta Ø

1,5

1,5

1,5



23.4166 18 cm
PROME(DUR)



ZIEGLER
23.4170 18 cm
PROME(DUR)

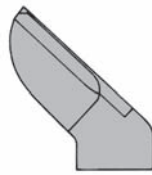

ZIEGLER
23.4171 22 cm
PROME(DUR)



HARVEY
23.4172 23 cm
PROME(DUR)

1,5

1,7

1,8

2,2

2,0

2,0

2,5

3,0

Kopfschneider – Front Cutters – Pincas à couper frontales – Alicates de cortar frontal



23.4190 15 cm
PROME(DUR)



DIAMOND
23.4196 21,5 cm
PROME(DUR)



23.4270 25 cm
PROME(DUR)

23.4272 38 cm
PROME(DUR)

für harten Draht bis Ø
 hard wire up to Ø
 fils durs jusqu'à Ø
 para duros hasta Ø

1,5

2,5

4,0

4,5

für weichen Draht bis Ø
 soft wire up to Ø
 fils moux jusqu'à Ø
 para blandos hasta Ø

2,0

3,5



23.4290 56 cm
PROME(DUR)

23.4292 45 cm
PROME(DUR)

6,0

5,0

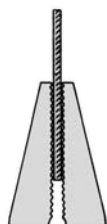

23.4205
 18 cm
 5 mm



23.4207
 18 cm
 7 mm



23.4210
 18 cm



23.4213
 18 cm
 2,5 mm
PROME(DUR)



23.4214
 18 cm
 3,5 mm
PROME(DUR)



23.4217
 18 cm
 7 mm
PROME(DUR)

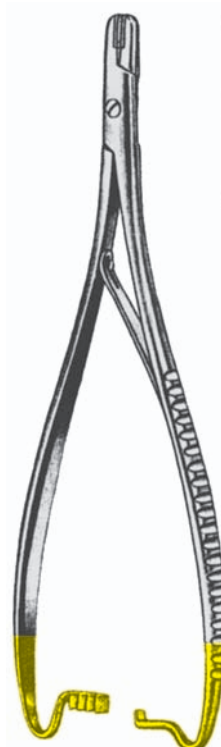

MATHIEU
23.4218
 20 cm **PROME(DUR)**



RUBIO
23.4219
 13 cm **PROME(DUR)**





MAYO-HABERISSER

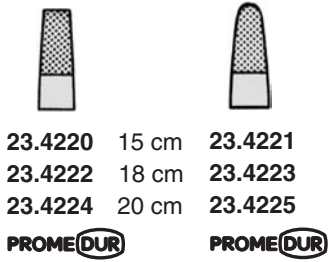

23.4220 15 cm 23.4221
23.4222 18 cm 23.4223
23.4224 20 cm 23.4225

PROME(DUR) PROME(DUR)



23.4230
17 cm



23.4232
17 cm

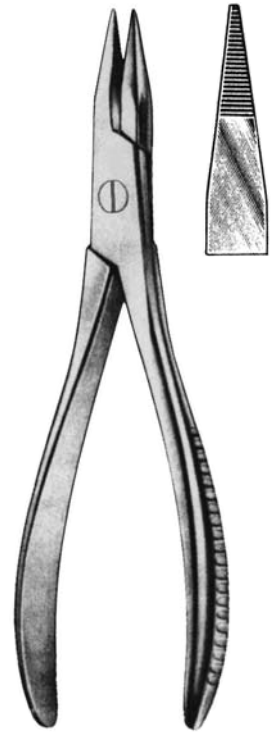

23.4235
19 cm

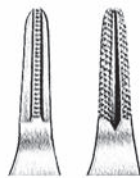

23.4236
13 cm

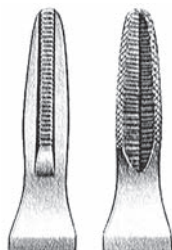

23.4238
18 cm



23.4239
17 cm PROME(DUR)

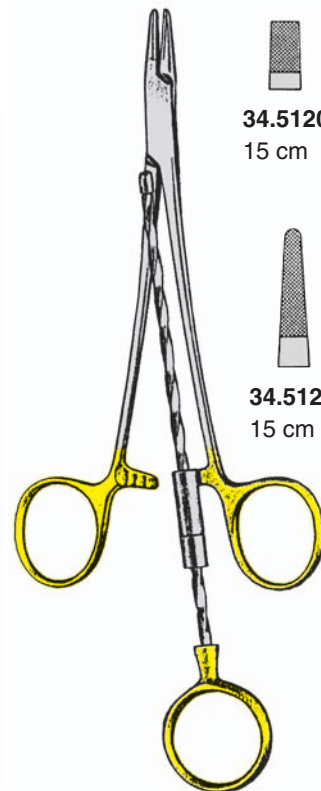

34.5120
15 cm

34.5122
15 cm

34.5124
15 cm

34.5126
18 cm

PROME(DUR)



23.4253
18 cm



23.4255
18 cm

für Draht bis 1,6 mm Ø
wire up to 1,6 mm Ø
fils jusqu'à 1,6 mm Ø
para hasta 1,6 mm Ø



23.4262
18 cm



23.4263
20 cm



23.4264
24 cm

Feststellzangen – Locking Pliers – Pinces auto-serrantes – Pinzas para hilos auto-cerrante

Spitzmaulzangen
Needle-nosed pliers
Pincès à bouts pointus
Pinzas con bocas agudas



23.4265
22 cm



23.4266
25 cm



23.4267
30 cm

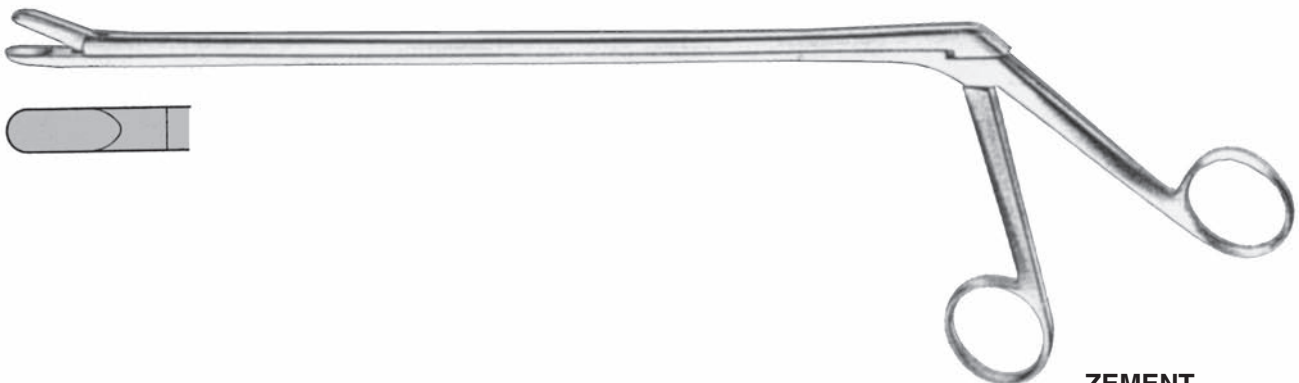

ZEMENT
23.2800
25 cm / 5x10 mm

Bohrdrahtspender
Wire-dispenser
Dispensateur pour broches
Distribuidor para taladros



L = cm	0,9 mm	1,0 mm	1,1 mm	1,2 mm	1,3 mm	1,4 mm	1,5 mm	1,6 mm	1,7 mm	1,8 mm	1,9 mm	2,0 mm	2,2 mm	2,5 mm
	Ø	Ø	Ø	Ø	Ø	Ø	Ø	Ø	Ø	Ø	Ø	Ø	Ø	Ø
18	23.4409	23.4410	23.4411	23.4412	23.4413	23.4414	23.4415	23.4416	23.4417	23.4418	23.4419	23.4420	23.4422	23.4425
32	23.4429	23.4430	23.4431	23.4432	23.4433	23.4434	23.4435	23.4436	23.4437	23.4438	23.4439	23.4440	23.4442	23.4445

	mm Ø	L = 6 cm	L = 12 cm	L = 14 cm	L = 16 cm	L = 31 cm
 Trokarspitze Trocar tip Pointe trocart Punta en forma de trócar KIRSCHNER	0,6	23.4446				
	0,7	23.4447	23.4467	23.4487	23.4507	23.4537
	0,8	23.4448	23.4468	23.4488	23.4508	23.4538
	0,9	23.4449	23.4469	23.4489	23.4509	23.4539
	1,0	23.4450	23.4470	23.4490	23.4510	23.4540
	1,1	23.4451	23.4471	23.4491	23.4511	23.4541
	1,2	23.4452	23.4472	23.4492	23.4512	23.4542
	1,3	23.4453	23.4473	23.4493	23.4513	23.4543
	1,4	23.4454	23.4474	23.4494	23.4514	23.4544
	1,5	23.4455	23.4475	23.4495	23.4515	23.4545
	1,6	23.4456	23.4476	23.4496	23.4516	23.4546
	1,7	23.4457	23.4477	23.4497	23.4517	23.4547
	1,8	23.4458	23.4478	23.4498	23.4518	23.4548
	1,9	23.4459	23.4479	23.4499	23.4519	23.4549
	2,0	23.4460	23.4480	23.4500	23.4520	23.4550
	2,2	23.4462	23.4482	23.4502	23.4522	23.4552
	2,5	23.4465	23.4485	23.4505	23.4525	23.4555

	mm Ø	L = 31 cm
 Lanzenspitze Lancet tip Pointe lancéolaire Punta lanceolar KIRSCHNER	0,9	23.4569
	1,0	23.4570
	1,1	23.4571
	1,2	23.4572
	1,3	23.4573
	1,4	23.4574
	1,5	23.4575
	1,6	23.4576
	1,7	23.4577
	1,8	23.4578
	1,9	23.4579
	2,0	23.4580
	2,2	23.4582
2,5	23.4585	

weitere Ausführungen auf Anfrage

please ask us for additional models/combinations

d'autres modèles sur demande

pregunten por otros modelos

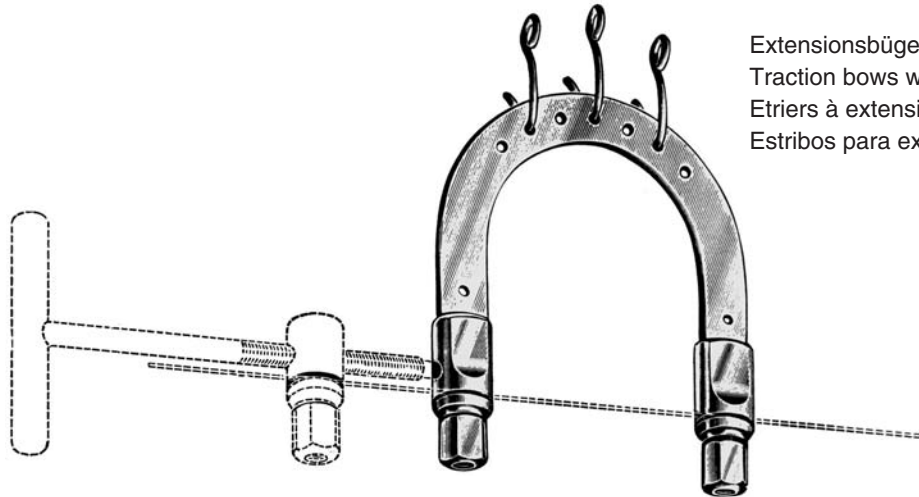

Extensionsbügel mit 3 Zughaken
Traction bows with 3 traction hooks
Etriers à extension avec 3 crochets de traction
Estribos para extensión con 3 ganchos de tracción



KIRSCHNER
23.4607 60 x 50 mm

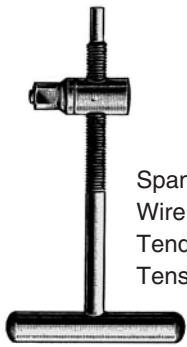

Spannschlüssel
Wire tighener
Tendeur de broches
Tensor de alambres

KIRSCHNER
23.4608

- KIRSCHNER**
- 23.4600** 200 x 155 mm
 - 23.4601** 155 x 155 mm
 - 23.4602** 135 x 130 mm
 - 23.4603** 120 x 120 mm
 - 23.4604** 105 x 105 mm
 - 23.4605** 95 x 110 mm
 - 23.4606** 95 x 70 mm

Fixierscheiben (Paar)
Fixation discs (pair)
Disques à fixation paire
Discos fijadores (par)

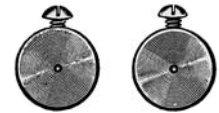

KIRSCHNER
23.4617



KIRSCHNER
23.4609

Spannschlüssel
Wrench
Clef plate
Llave de tuercas



23.4610 18 x 10 cm
23.4611 27 x 16 cm



KIRSCHNER
23.4614



KIRSCHNER
23.4615

Zughaken
Traction hooks
Crochet de traction
Ganchos de tracción

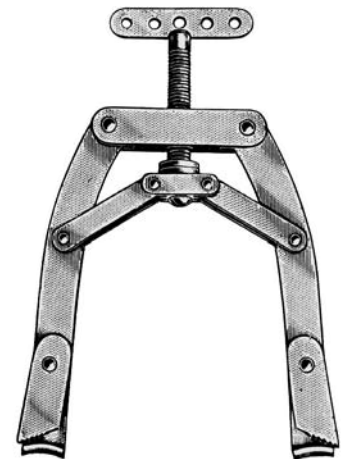

KIRSCHNER
23.4618

max. Öffnung
max. jaw opening
ouverture max.
apertura max.

- 130 mm**
- US-Mod. klein
- 23.4619** **185 mm**
- US-Mod. gross
- 23.4620** **220 mm**
- US-Mod. X-Gross



STEINMANN Nägel
STEINMANN pins
STEINMANN clous à os
STEINMANN chiodi per ossa

L = cm	
8	24.2840
10	24.2841
12	24.2842
14	24.2843
15	24.2844
16	24.2845
18	24.2846
20	24.2847
21	24.2848

STEINMANN
Ø 4 mm

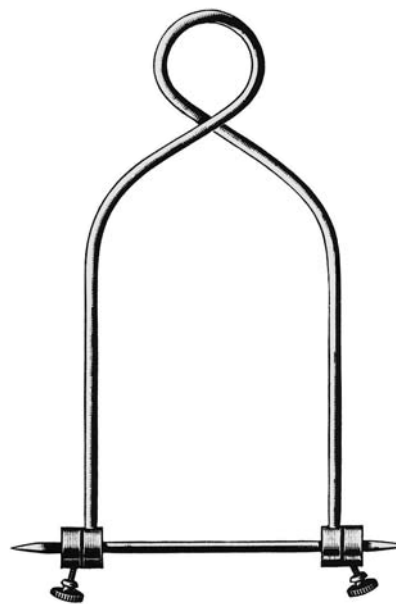

BOEHLER
24.2959 90 x 75 mm
24.2960 160 x 90 mm
24.2962 210 x 110 mm

Extensionsbügel zur Verwendung mit STEINMANN Nägeln
Traction bows for use with STEINMANN pins
Etriers de traction à utiliser avec clous de STEINMANN
Estribos para extensión para clavos de STEINMANN

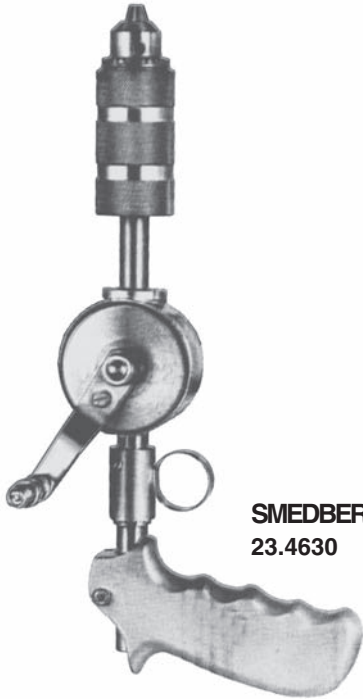

SMEDBERG
23.4630



23.4651

KIRSCHNER
23.4650

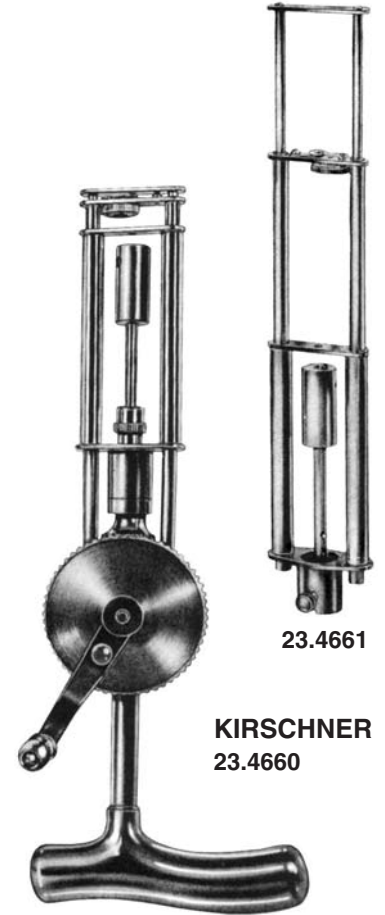

23.4661

KIRSCHNER
23.4660

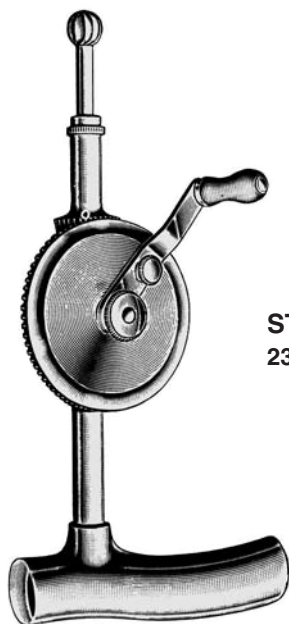

STILLE
23.4670



STILLE-SHERMAN
23.4675



MOORE
 23.4680



23.4685

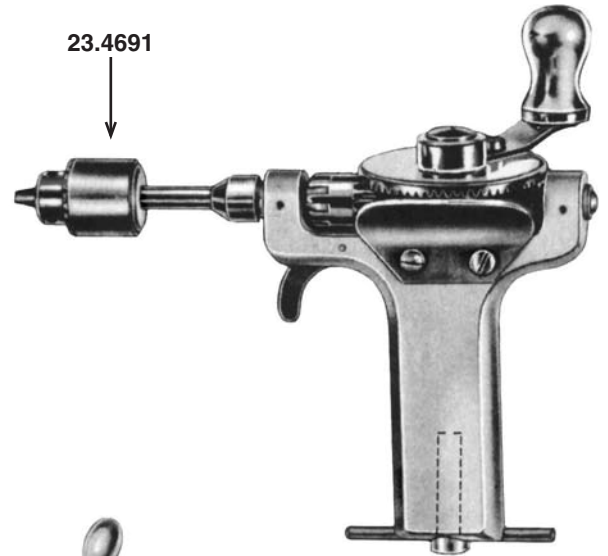

BUNNELL
 23.4690

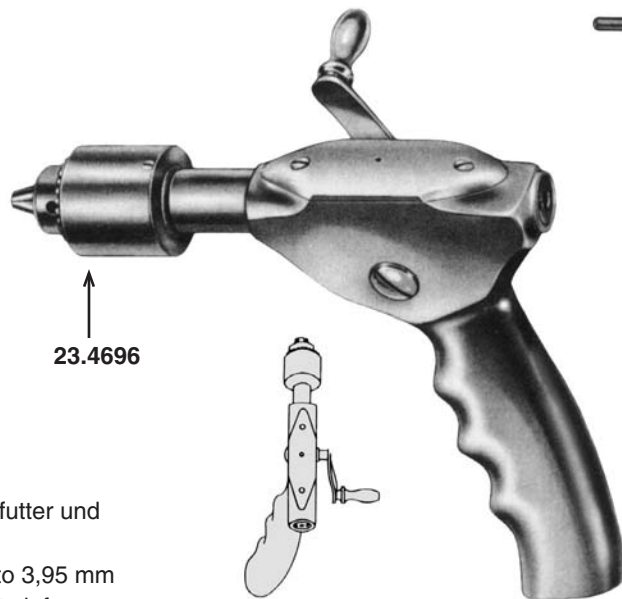

23.4696

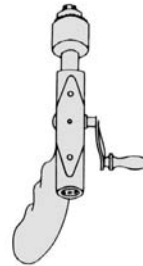

RALK
 23.4695



23.4697 14 cm
 Handgriff mit Dreibackenspannfutter und Schlüssel bis 3,95 mm
 Handle with chuck and key up to 3,95 mm
 Poignée en "T" avec mandrin et clef ouverture max. : 3,95 mm
 Perforador a mano con mandril y llave hasta 3,95 mm

23.4699
 Ersatzschlüssel
 Spare wrench
 Clef de rechange
 Llave de repuesto



23.4700 12 cm
 Handgriff mit Dreibackenspannfutter und Schlüssel bis 6,35 mm
 Handle with chuck and key up to 6,35 mm
 Poignée en "T" avec mandrin et clef ouverture max. : 6,35 mm
 Perforador a mano con mandril y llave hasta 6,35 mm

23.4701
 Ersatzschlüssel
 Spare wrench
 Clef de rechange
 Llave de repuesto



23.4702 16 cm / 6,35 mm



- 23.4770 1,0 mm
- 23.4772 1,5 mm
- 23.4774 2,0 mm
- 23.4776 2,5 mm
- 23.4777 2,7 mm
- 23.4778 3,0 mm
- 23.4779 3,2 mm
- 23.4780 3,5 mm
- 23.4781 4,0 mm
- 23.4782 4,5 mm
- 23.4783 5,0 mm

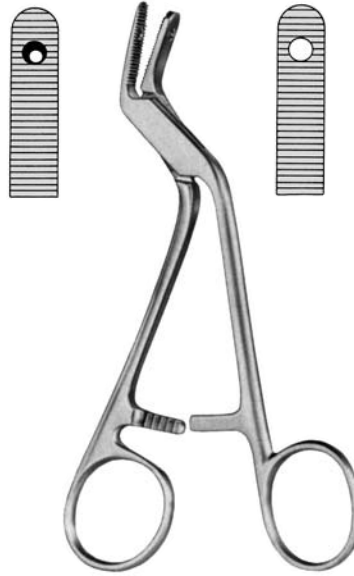

ADSON

23.4990 15 cm

Bohrerführungs- und Dura-Schutzzange
Drill guide and dura protecting forceps
Pince-guide mèche et protège dure-mère
Pinza-guia para taladros y para proteger
la dura-madre

Reibahlen
Reamers
Pointes-carrées
Escariadores



23.4996 14 cm



23.4997 14 cm



PERTHES

23.4998 21,5 cm