

**PRO-MED**



Knochenchirurgie / Neurochirurgie / Mikrochirurgie

Bone Surgery / Neuro Surgery / Micro Surgery

Chirurgie osseuse / Neurochirurgie / Microchirurgie

Cirurgia osea / Neuro Cirurgia / Micro Cirurgia

**PRO-MED**

NEUROCHIRURGIE

NEUROSURGERY

NEUROCHIRURGIE

NEUROCIRUGIA



**ADSON**  
**27.0056**  
21 cm / 4 mm  
Charr. / Fr. 12



**ADSON**  
**27.0057**  
21 cm / 4 mm  
Charr. / Fr. 12



**FRAZIER**  
**27.0066** 10 cm / 2,0 mm  
**27.0067** 10 cm / 2,5 mm  
**27.0068** 10 cm / 3,0 mm



**27.0070**  
1,8 + 1,8 mm



**27.0071**  
2,5 + 2,0 mm



**27.0072**  
3,0 + 2,0 mm



**HOUSE**  
18 cm



**HOUSE**  
**27.0073** 9 cm / 0,9 + 0,7 mm  
**27.0074** 9 cm / 1,2 + 0,9 mm  
**27.0075** 9 cm / 1,5 + 1,2 mm



**FISCH**  
**27.0076** 9 cm / 1,8 + 1,8 mm  
**27.0077** 9 cm / 2,5 + 2,0 mm  
**27.0078** 9 cm / 3,0 + 2,0 mm  
**27.0079** 9 cm / 4,5 + 2,0 mm



**27.0094**  
 Ø 0,4 mm

**27.0096**  
 Ø 0,6 mm

**27.0098**  
 Ø 0,8 mm

**WULLSTEIN**

**27.0090** Mikro-Absaugrohr komplett, bestehend aus:  
 27.0091 Absaugrohr mit Luer-Bohrung  
 27.0094 Mikro-Saugkanüle 0,4 mm  
 27.0096 dito 0,6 mm  
 27.0098 dito 0,8 mm

Micro-canule aspiratrice complète, comprenant de:  
 27.0091 Tube à aspiration, embout Luer  
 27.0094 Micro-canule 0,4 mm  
 27.0096 dito 0,6 mm  
 27.0098 dito 0,8 mm

Micro-suction tube, complete, consisting of:  
 27.0091 Suction tube with Luer hub  
 27.0094 Micro suction cannula 0,4 mm  
 27.0096 ditto 0,6 mm  
 27.0098 ditto 0,8 mm

Aspirador micro, complete, compuesto de:  
 27.0091 Tubo de aspiración micro para cono Luer  
 27.0094 Canula de aspiración micro 0,4 mm  
 27.0096 idem 0,6 mm  
 27.0098 idem 0,8 mm

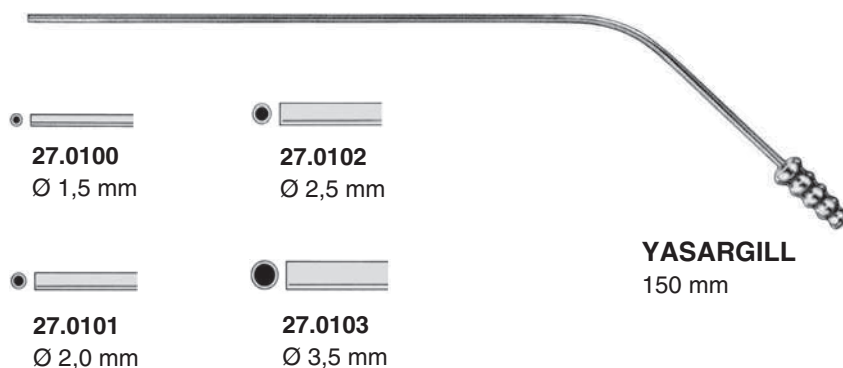

**27.0100**  
 Ø 1,5 mm

**27.0102**  
 Ø 2,5 mm

**27.0101**  
 Ø 2,0 mm

**27.0103**  
 Ø 3,5 mm

**YASARGILL**  
 150 mm

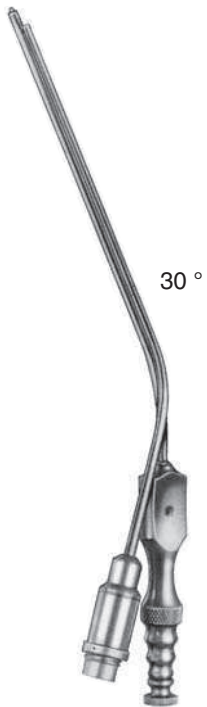

### FRAZIER

mit Kaltlicht  
with fiber optics  
avec lumière froide  
con luz fria

- 27.0152** 8 Charr. / Fr.
- 27.0154** 10 Charr. / Fr.
- 27.0156** 12 Charr. / Fr.



### FRAZIER

- 27.0170** 6 Charr. / Fr.
- 27.0171** 7 Charr. / Fr.
- 27.0172** 8 Charr. / Fr.
- 27.0173** 9 Charr. / Fr.
- 27.0174** 10 Charr. / Fr.
- 27.0175** 11 Charr. / Fr.
- 27.0176** 12 Charr. / Fr.
- 27.0176E** 12 Charr. / Fr.
- 27.0179** 15 Charr. / Fr.

**E** = isoliert - insulated - isolé - con aislamiento



### FERGUSON

- 27.0180** 6 Charr. / Fr.
- 27.0181** 7 Charr. / Fr.
- 27.0181E** 7 Charr. / Fr.
- 27.0182** 8 Charr. / Fr.
- 27.0183** 9 Charr. / Fr.
- 27.0183E** 9 Charr. / Fr.
- 27.0184** 10 Charr. / Fr.
- 27.0185** 11 Charr. / Fr.
- 27.0185E** 11 Charr. / Fr.
- 27.0186** 12 Charr. / Fr.
- 27.0187** 15 Charr. / Fr.



### FRAZIER

- 27.0190** 6 Charr. / Fr.
- 27.0191** 7 Charr. / Fr.
- 27.0192** 8 Charr. / Fr.
- 27.0193** 9 Charr. / Fr.
- 27.0194** 10 Charr. / Fr.
- 27.0195** 11 Charr. / Fr.
- 27.0196** 12 Charr. / Fr.

**E** = isoliert - insulated - isolé - con aislamiento

### 27.0199

Reinigungsdraht für FRAZIER/FERGUSON  
Replacement Stylet for FRAZIER/FERGUSON  
Tige de rechange pour FRAZIER/FERGUSON  
Alambre de recambio para FRAZIER/FERGUSON



**HUDSON**  
27.0209



**27.0202**  
9 mm Ø



**27.0203**  
14 mm Ø



**27.0204**  
16 mm Ø



**27.0205**  
22 mm Ø

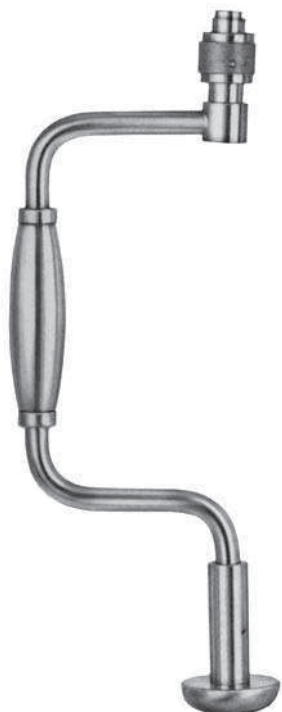

**HUDSON**  
**27.0200**

Handbohrapparat mit Fräsern 27.0202 bis 27.0205 und Verlängerungsstück 27.0209  
 Hand drill with 4 burrs 27.0202 - 27.0205 and extension piece 27.0209  
 Vilebrequin a main avec Fraises 27.0202 - 27.0205 et rallonge 27.0209  
 Perforador de mano, con 4 fresas 27.0202 - 27.0205 y pieza de prolongación 27.0209

**27.0201**

Bohrwinde / hand drill / Vilebrequin seul / Perforador de mano suelto



**CUSHING**  
**27.0206**  
14 mm Ø



**McKENZIE**  
**27.0207**  
14 mm Ø



**D'ERRICO**  
**27.0208**  
14 mm Ø



**ADSON**  
**27.0212**  
2 mm Ø

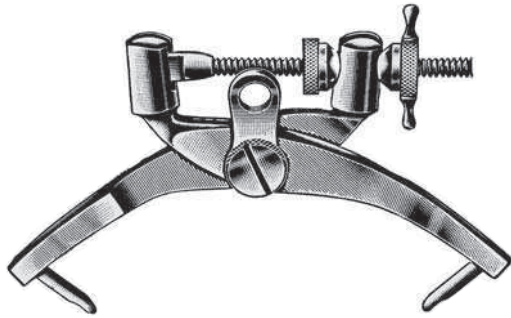

**CRUTCHFIELD**  
 27.0400 11 cm



**CRUTCHFIELD**  
 27.0402 13 cm



**27.0408**  
 3,5 mm Ø



**27.0409**  
 5 mm Ø



**CRUTCHFIELD**  
 27.0430

Schädelhalter für Halswirbelextension  
 for extension of the neck vertebrae  
 pour tractions cervicales  
 para la extensión de las vertebrae de cuello

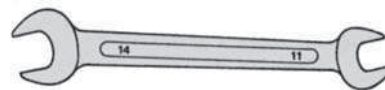

**27.0438**  
 11 / 14 mm  
 Schraubenschlüssel / wrench / clef / llave inglesa

**27.0439**  
 Ersatzdorn / Spare pin  
 Broches de rechange / Punta de repuesto suelta



**CONE**  
27.0500  
19 cm / 7 mm  
27.0502  
23 cm / 12 mm



**DEVILBIS**  
27.0510  
21 cm



**DAHLGREN**  
27.0515  
20 cm



**GIGLI**  
27.0520  
27.0521  
Paar / pair / paire / par

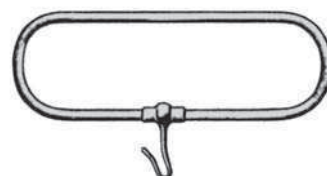

**GIGLI**  
27.0525

Einführungsinstrument für Drahtsägen  
 Conductor for wire saws  
 Conducteur pour scies  
 Conductor para sierras de hilo



**OLIVECRONA (GIGLI)**

- 27.0530 30 cm
- 27.0531 40 cm
- 27.0532 50 cm
- 27.0533 60 cm
- 27.0534 70 cm



**MARTEL**

- 27.0540 33 cm  
gerade / straight  
droit / recta
- 27.0541 33 cm  
gebogen / curved  
courbe / curva



**GALT**

- 27.0600 13 mm Ø
- 27.0601 16 mm Ø
- 27.0602 19 mm Ø
- 27.0603 22 mm Ø
- 27.0604 25 mm Ø

Trephinen  
 Trephines  
 Tréphines  
 Trepanos

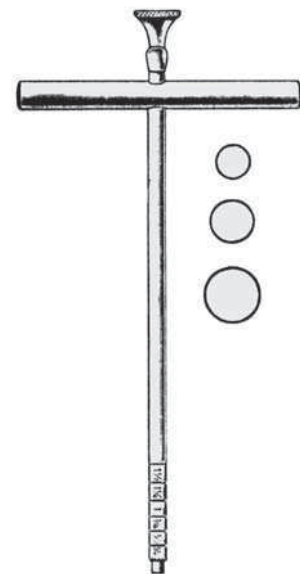

**MICHELE**

- 27.0610 5,0 mm Ø
- 27.0611 5,5 mm Ø
- 27.0612 8,0 mm Ø

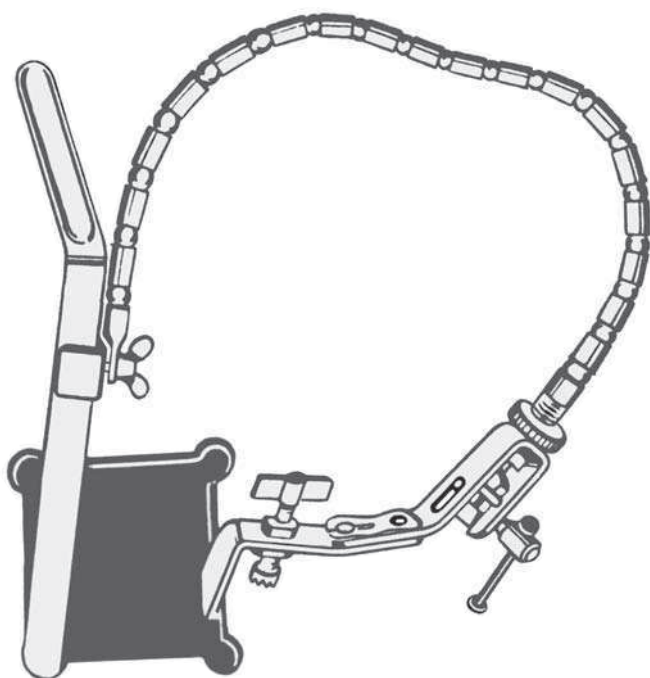

**LEYLA**

**27.0700**

Hirnspatelhalter, einfach bestehend aus:

**27.0705** 1 flexibler Spannarm

**27.0706** 1 Fixiervorrichtung

**27.0709** 1 Spatelhalterung

Retractor set, single, consisting of:

**27.0705** 1 flexible arm

**27.0706** 1 fixation base

**27.0709** 1 support for flat spatulas

Ecarteur simple, comprenant:

**27.0705** 1 bras tendeur flexible

**27.0706** 1 Étau crânien

**27.0709** 1 porte-instrument-plat

Separador singular, compuesto de:

**27.0705** 1 brazo flexible

**27.0706** 1 dispositivo a fijación

**27.0709** 1 porta-espátulas para espátulas planos

**LEYLA**

**27.0701**

Hirnspatelhalter, doppelt bestehend aus:

**27.0705** 2 flexible Spannarme

**27.0707** 1 Fixiervorrichtung

**27.0709** 2 Spatelhalterungen

Retractor set, double, consisting of:

**27.0705** 2 flexible arms

**27.0707** 1 fixation base

**27.0709** 2 supports for flat spatulas

Ecarteur double, comprenant:

**27.0705** 2 bras tendeur flexibles

**27.0707** 1 Étau crânien

**27.0709** 2 porte-instruments

Separador doble, compuesto de:

**27.0705** 2 brazos flexibles

**27.0707** 1 dispositivo a fijación

**27.0709** 2 porta-espátulas para espátulas planos

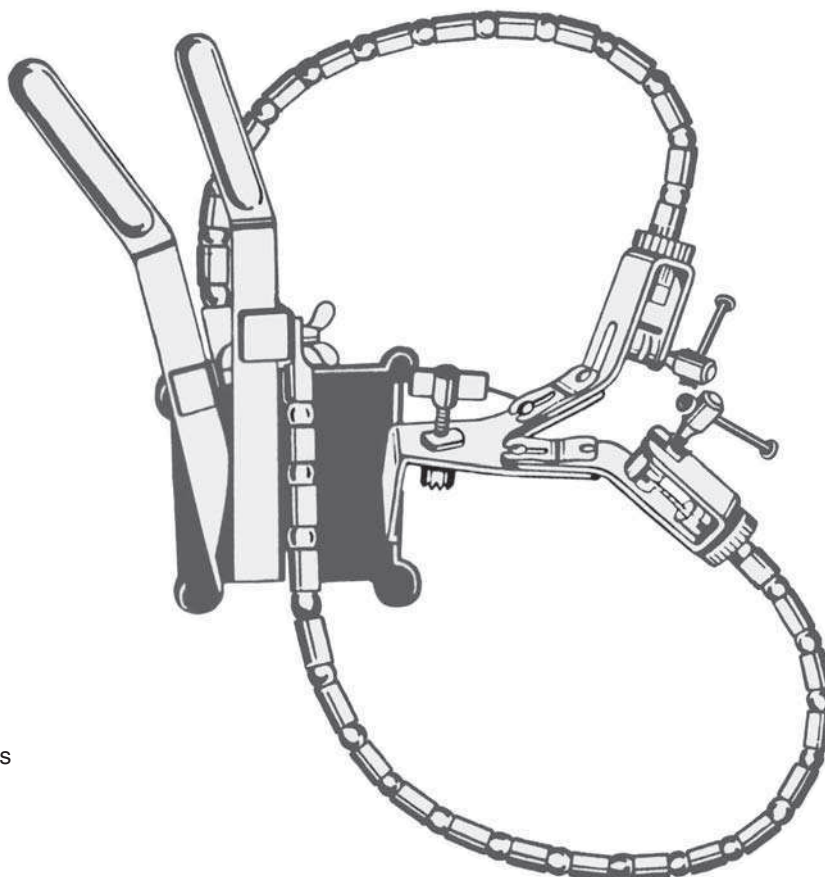

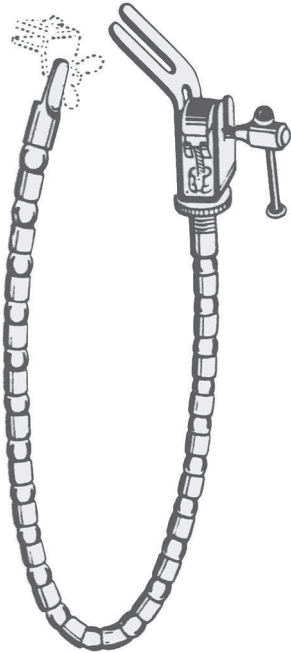

**27.0705**  
Spannarm allein  
Flexible arm only  
Bras tendeur flexible seul  
Brazo flexible



**27.0706**  
Fixiervorrichtung für 1 Spannarm  
Fixation base for 1 flexible arm  
Étau crânien simple pour 1 bras flexible  
Dispositivo a fijación para 1 brazo flexible



**27.0707**  
Fixiervorrichtung für 2 Spannarme  
Fixation base for 2 flexible arms  
Étau crânien double, 2 bras tendeurs flexibles  
Dispositivo a fijación doble para 2 brazo flexible



**27.0708**  
Fixiervorrichtung zum  
Festschrauben an Rohrteilen  
Fixation base, for mounting  
to round bars  
Étau crânien, s'adaptant à la  
table d'operation  
Dispositivo a fijación para  
mesas operatirias

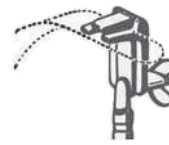

**27.0709**  
Flachspatelhalter  
Support for flat  
spatulas  
Porte-spatule, pour  
spatules plates  
Porta-espátulas,  
para espátulas  
planos



**27.0710**  
Spatelhalter für  
Rundgriff-Instrumente  
Support for round  
spatulas  
Porte-spatule, pour  
instruments à manches  
rondes  
Porta-espátulas, para  
espátulas con mangos  
rondes

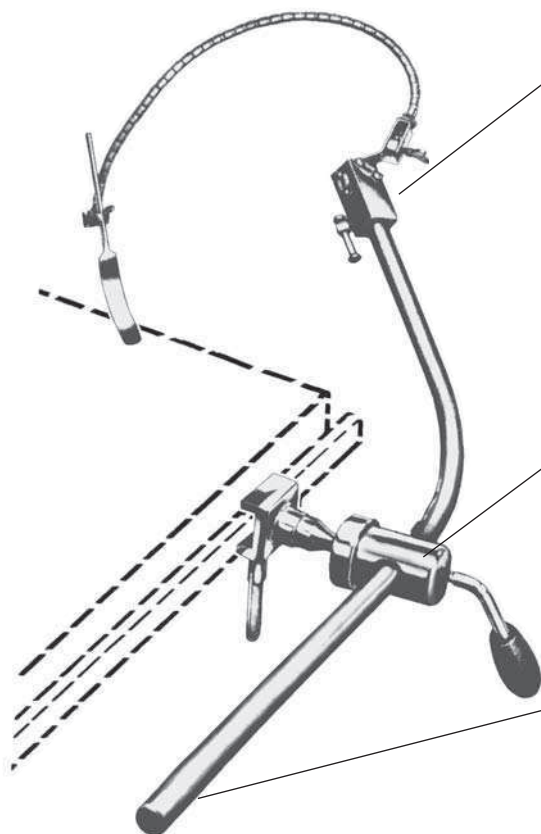

**27.0712**  
Kupplungskopf, für  
1 - 5 Spannarme  
Coupling head, for  
1 - 5 flexible arms  
Tête porte-bras, pour  
1 - 5 bras flexibles  
Cabeza porta-brazos, para  
1 - 5 brazos flexibles

**27.0713**  
Kugelgelenkvorrichtung  
Ball and socket joint  
Rotule  
Rotula

**27.0711**  
Haltearm, starr  
Holding rod, rigid  
Potence, rigid  
Brazo rigido

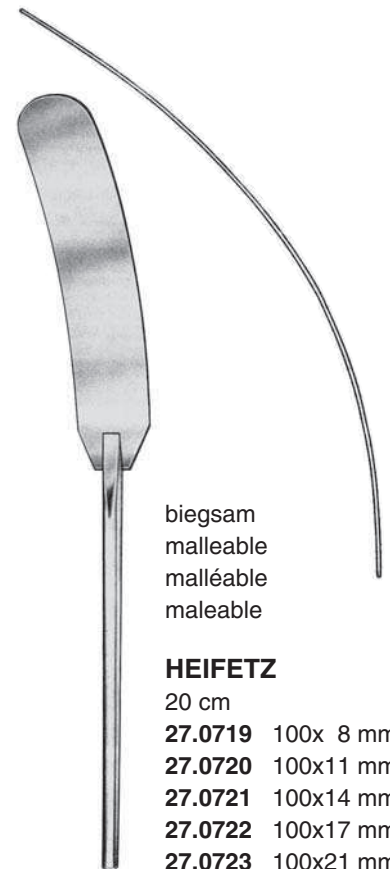

biegsam  
malleable  
malléable  
maleable

### HEIFETZ

20 cm

- 27.0719** 100x 8 mm
- 27.0720** 100x11 mm
- 27.0721** 100x14 mm
- 27.0722** 100x17 mm
- 27.0723** 100x21 mm

Chordotomie-Messer / Cordotomy Knives / Bistouris pour cordotomie / Bisturios para cordotomia



**BUCY**  
 27.0791 17 cm



**BUCY**  
 27.0792 17 cm



**BUCY**  
 27.0793 17 cm

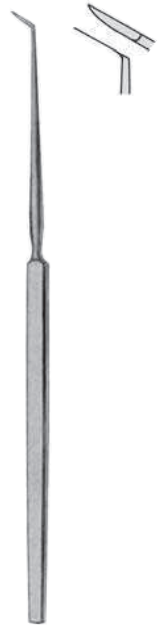

**BUCY**  
 27.0794 17 cm

Unterbindungsnadel / Ligature Needle  
 Aiguille à ligatures / Aguja para ligaduras

Elevatorien / Elevators / Elévateurs / Elevadores

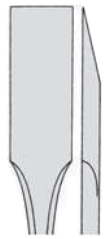

**27.0800**



**27.0801**

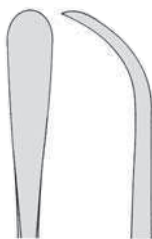

**27.0802**

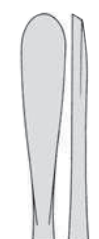

**27.0803**

**ADSON**  
 17 cm



**27.0810**  
 16 cm / 7 mm

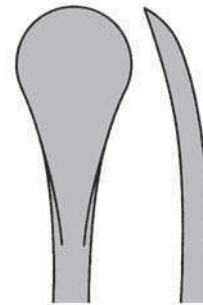

**27.0811**  
 19 cm / 15 mm

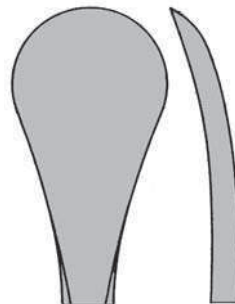

**27.0812**  
 19 cm / 20 mm

**HOEN-MARTIN**



**ADSON**  
 27.0860  
 23 cm



**HORSELY**  
27.0870  
19 cm



**FRAZIER**  
27.0880  
15 cm



**HOEN**  
27.0890  
15 cm 45°



**HOEN**  
27.0891  
15 cm 90°

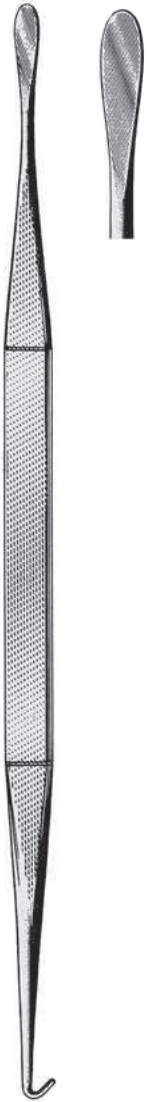

**SMITHWICK**  
27.0900  
29 cm

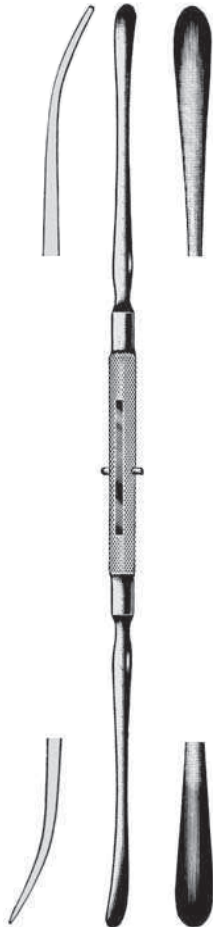

**DAVIS**  
27.0910  
24,5 cm



**DAVIS**  
27.0912  
19 cm



**PENFIELD**  
**27.0921**  
17,5 cm #1

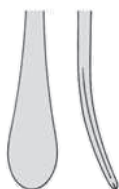

**PENFIELD**  
**27.0922**  
19,5 cm #2

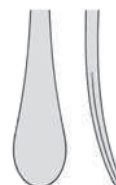

**PENFIELD**  
**27.0923**  
19,5 cm #3

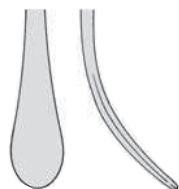

**PENFIELD**  
**27.0924**  
21,5 cm #4



**PENFIELD**  
**27.0925**  
29 cm #5



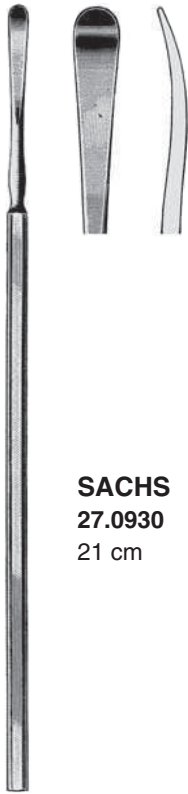

**SACHS**  
27.0930  
21 cm



**SACHS**  
27.0931  
21 cm



**MILLIGAN**  
27.0936  
21 cm



**TOENNIS**  
27.0940 3,5 / 5 mm  
25 cm  
27.0942 4,5 / 6 mm  
25 cm

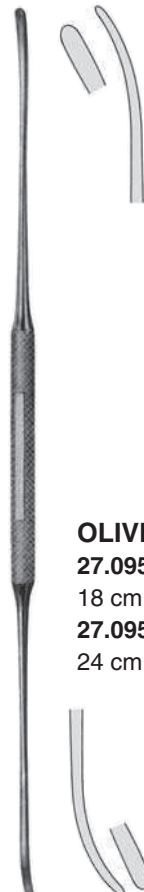

**OLIVECRONA**  
27.0950 2 / 3 mm  
18 cm  
27.0951 2 / 3 mm  
24 cm

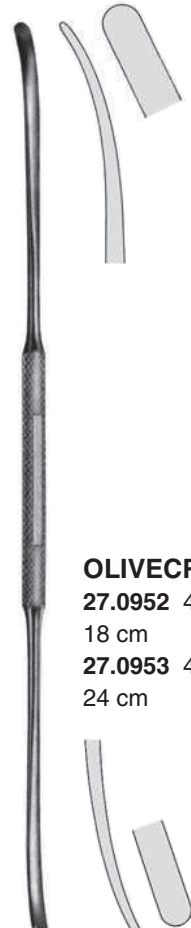

**OLIVECRONA**  
27.0952 4 / 5 mm  
18 cm  
27.0953 4 / 5 mm  
24 cm



**HALLE**  
**27.0960**  
 20 cm



**OLIVECRONA**  
 konkav / concave  
 concave / cóncavas  
 18 cm  
**27.1000** 7 x 9 mm  
**27.1001** 11 x 13 mm  
**27.1002** 15 x 18 mm  
**27.1003** 18 x 22 mm



**OLIVECRONA**  
 konvex / convex  
 convexe / convexas  
 18 cm  
**27.1005** 7 x 9 mm  
**27.1006** 11 x 13 mm  
**27.1007** 15 x 18 mm  
**27.1008** 18 x 22 mm



**CUSHING**  
**27.1010**  
 17 cm 8 x 10 mm  
**27.1012**  
 20 cm 13 x 15 mm

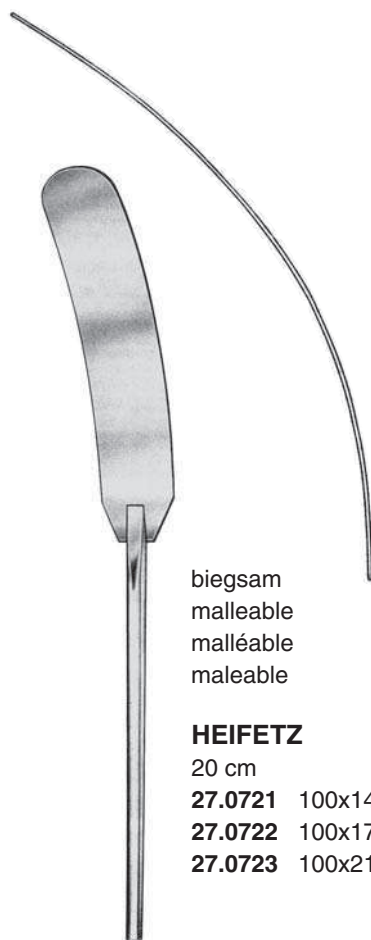

biegsam  
 malleable  
 malléable  
 maleable

**HEIFETZ**  
 20 cm  
**27.0721** 100x14 mm  
**27.0722** 100x17 mm  
**27.0723** 100x21 mm

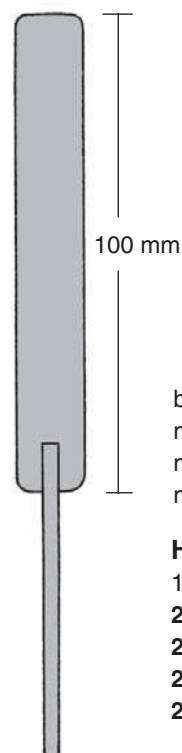

biegsam  
 malleable  
 malléable  
 maleable

**HEIFETZ**  
 15 cm  
**27.1026** 8 mm  
**27.1027** 11 mm  
**27.1028** 14 mm  
**27.1029** 17 mm



## “AACHEN”

20 cm

- 27.1041** 7/ 8 mm
- 27.1042** 10/11 mm
- 27.1043** 13/14 mm
- 27.1044** 16/17 mm
- 27.1045** 19/20 mm
- 27.1046** 22/25 mm



## DAVIS

18 cm

- 27.1050** 6,0 mm
- 27.1051** 9,5 mm
- 27.1052** 13,5 mm
- 27.1053** 16,0 mm
- 27.1054** 19,0 mm
- 27.1055** 25,0 mm
- 27.1056** 32,0 mm
- 27.1057** 38,0 mm



## SCOVILLE

20 cm

- 27.1060** 10/13 mm
- 27.1061** 16/19 mm

biegsam / malleable / malléable / maleable



**27.1100**



**27.1101**



**27.1102**

**SCOVILLE**  
25 cm



**TAYLOR**  
**27.1150**  
75 x 30 mm  
**27.1152**  
100 x 30 mm



**CLOWARD**  
**27.1160**  
76 x 13 mm  
**27.1161**  
76 x 18 mm  
**27.1162**  
76 x 20 mm  
**27.1163**  
76 x 23 mm



**27.1201**  
90°



**27.1202**  
45°

**CRILE**  
20 cm



**HOEN**  
**27.1206**  
22 cm



**ADSON**  
**27.1210** 20 cm  
 spitz / sharp  
 pointu / agudo



**ADSON**  
**27.1211** 20 cm  
 stumpf / blunt  
 mousses / romo



**GRAHAM**  
**27.1220**  
16,5 cm



**SACHS**  
 27.1222  
 18 cm



**SMITHWICK**  
 27.1226  
 17 cm



**SMITHWICK**  
 27.1228  
 21 cm



**DANDY**  
 27.1230  
 20 cm



**DANDY**  
 27.1231  
 20 cm



**DANDY**  
 27.1232  
 20 cm



**CUSHING**  
 27.1240  
 19 cm / 5 mm  
**27.1245**  
 28 cm / 5 mm



**CUSHING**  
 27.1241  
 19 cm / 8 mm  
**27.1246**  
 28 cm / 8 mm

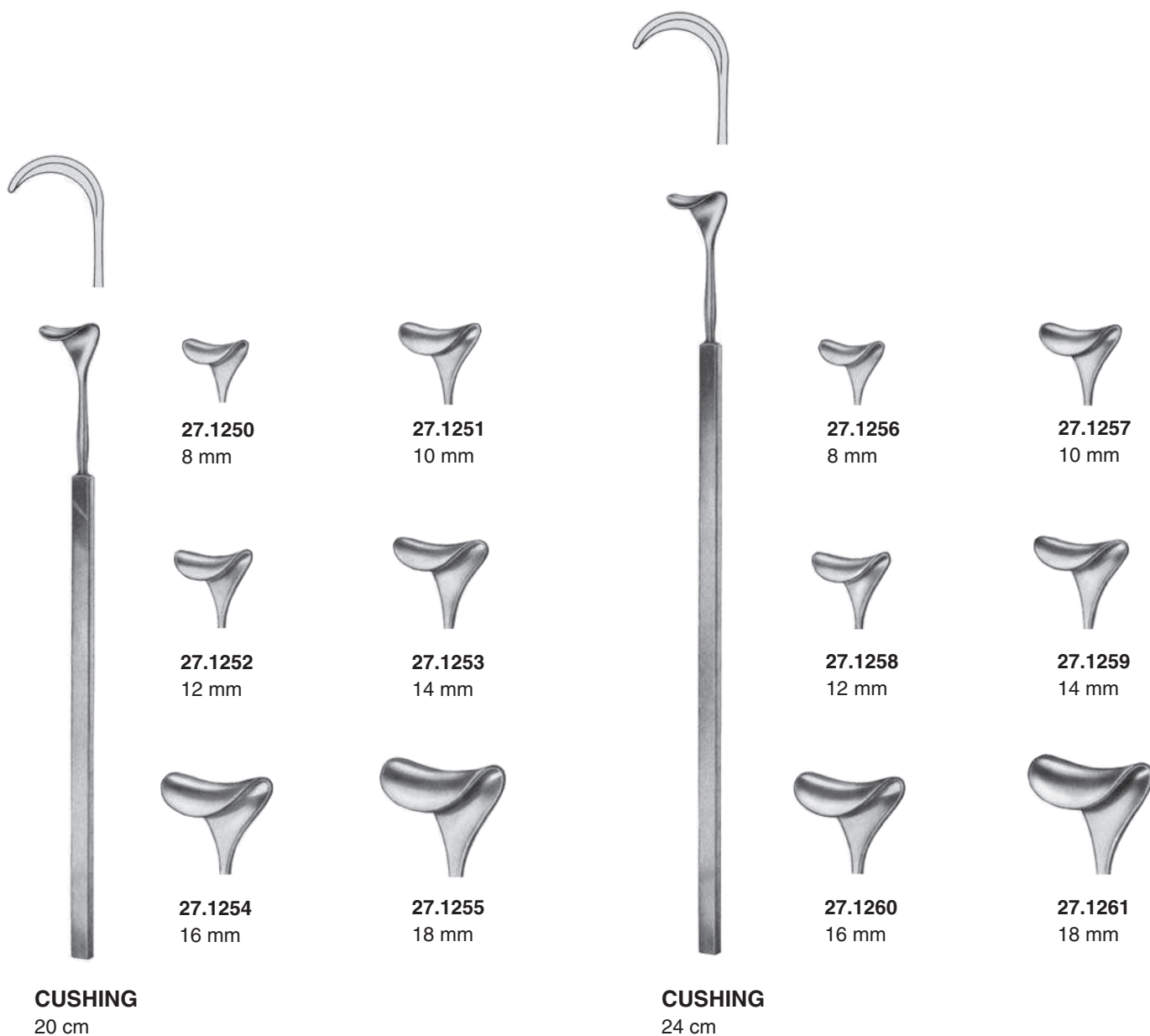

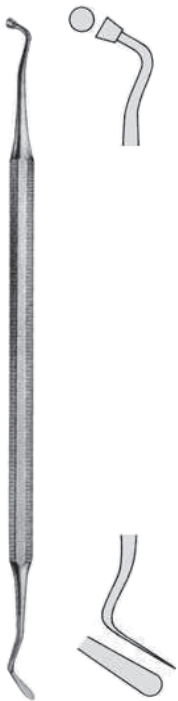

**WOODSON**  
 27.1296  
 18 cm



**LAHEY**  
 27.1305  
 13 cm



**FRAZIER**



**27.1310**  
 13 cm  
 spitz  
 sharp  
 pointu  
 agudo



**27.1311**  
 13 cm  
 stumpf  
 blunt  
 mousse  
 romo



**27.1312**  
 18 cm  
 spitz  
 sharp  
 pointu  
 agudo



**27.1313**  
 18 cm  
 stumpf  
 blunt  
 mousse  
 romo



**CUSHING**  
 27.1320  
 14 cm



**CUSHING**  
 27.1325  
 14 cm



**CLOWARD**  
 27.1330  
 16,5 cm



**SPEARE**  
 27.1335  
 14 cm



**TOENNIS**  
 27.1340  
 15 cm



**SCOVILLE**  
 27.1390  
 23 cm / 8 mm



**SCOVILLE**  
 27.1391  
 23 cm / 8 mm



**LOVE**  
 27.1400  
 19 cm / 7 mm

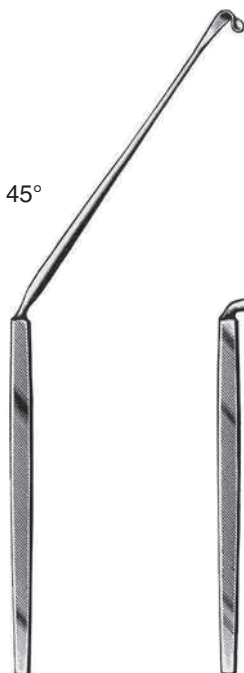

**LOVE**  
 27.1402  
 18 cm / 7 mm



**LOVE**  
 27.1404  
 11 cm / 7 mm



**LOVE**  
 27.1406  
 21 cm



**SCOVILLE**  
27.1410  
30,5 cm



**SCOVILLE**  
27.1412  
30,5 cm



**HOLSHER**  
27.1413  
25 cm / 7 mm



**CUSHING**  
27.1420  
20 cm



**D'ERRICO**  
27.1425  
23 cm

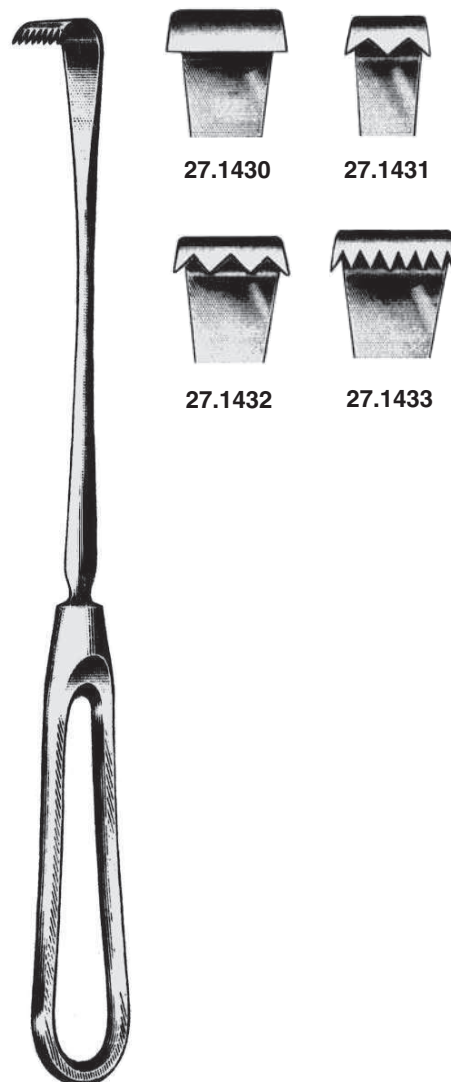

**OLDBERG**  
20 cm



**CLOWARD**

**17.8000** 17 cm  
 mit 5 Valven  
 with 5 blades  
 avec 5 valves  
 con 5 valvas

**17.8001** 17 cm  
 ohne Valven  
 without blades  
 sans valves  
 sin valvas



stumpf  
 blunt  
 mousse  
 romo

- 17.8002** 40 mm
- 17.8003** 45 mm
- 17.8004** 50 mm
- 17.8005** 55 mm
- 17.8006** 60 mm

**17.8007**

Satz von 5 stumpfen Valven  
 set of 5 blunt blades  
 jeu à 5 valves mousses  
 juego de 5 valvas romas



**CLOWARD**

**17.8010** 25 cm  
 mit 5 Valven  
 with 5 blades  
 avec 5 valves  
 con 5 valvas

**17.8011** 25 cm  
 ohne Valven  
 without blades  
 sans valves  
 sin valvas



spitz  
 sharp  
 pointu  
 agudo

- 17.8012** 40 mm
- 17.8013** 45 mm
- 17.8014** 50 mm
- 17.8015** 55 mm
- 17.8016** 60 mm

**17.8017**

Satz von 5 spitzen Valven  
 set of 5 sharp blades  
 jeu à 5 valves pointues  
 juego de 5 valvas agudas

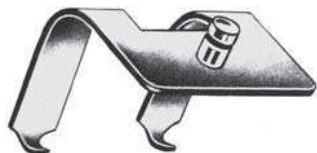

**17.8042** 45 x 35 mm

**17.8043** 45 x 45 mm

spitz  
 sharp  
 pointu  
 agudo



**17.8044** 25 x 35 mm

**17.8045** 25 x 45 mm

stumpf  
 blunt  
 mousse  
 romo



**17.8052**

50 mm



**17.8053**

64 mm



**HOEN**

**17.8040** 27 cm

mit 4 Valven / with 4 blades (17.8042 - 17.8045)  
 avec 4 valves / con 4 valvas

**17.8041** 27 cm

ohne Valven / without blades  
 sans valves / sin valvas



**CLOWARD-HOEN**

**17.8050** 25 cm

mit je 2 Valven 17.8052 & 17.8053  
 with 2 ea. blades 17.8052 & 17.8053  
 avec 2 valves 17.8052 et 2 valves 17.8053  
 con 2 valvas 17.8052 y 2 valvas 17.8053

**17.8051** 25 cm

ohne Valven / without blades / sans valves / sin valvas

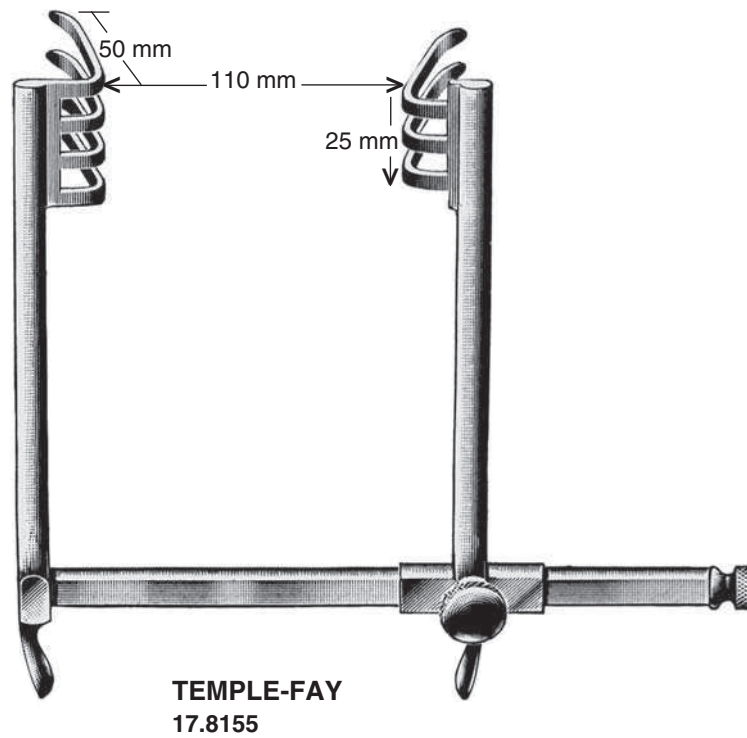
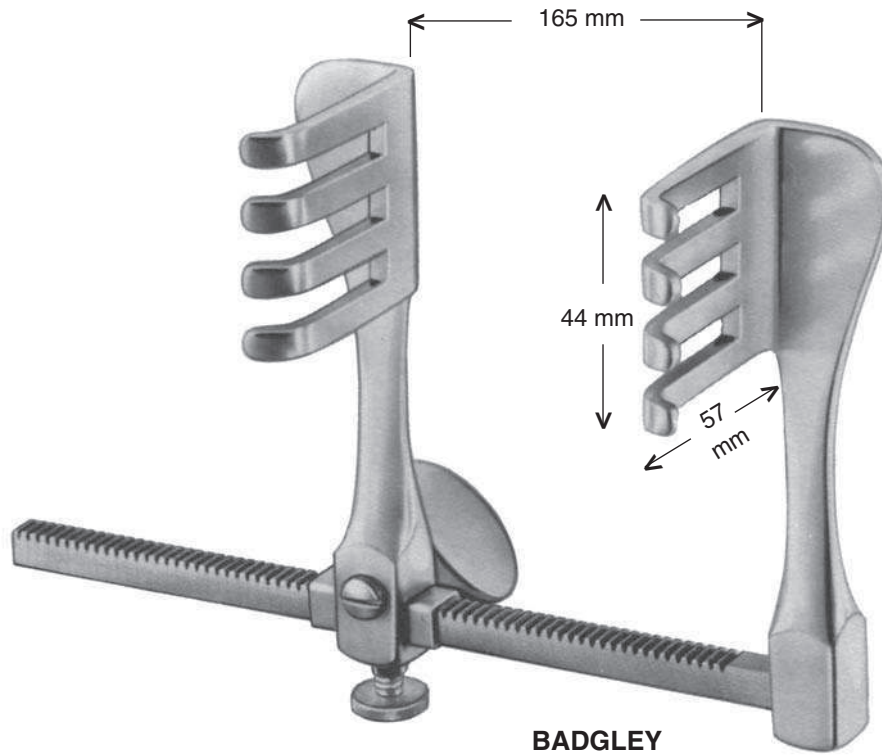



**SCOVILLE**

**17.8160**

Rahmen alleine  
 Frame only  
 cadre seul  
 cuadro suelto

**SCOVILLE**

**17.8161**

bestehend aus: 17.8160 Rahmen, 17.8172 Haken, 17.8174 Valve  
 consisting of: 17.8160 frame, 17.8172 hook, 17.8174 blade  
 comprenant de: 17.8160 cadre, 17.8172 crochet, 17.8174 valve  
 compuesto de: 17.8160 cuadro, 17.8172 gancho, 17.8174 valve



**SCOVILLE**

**17.8170** 50 mm  
**17.8171** 75 mm

**SCOVILLE**

**17.8172** 50 mm  
**17.8173** 75 mm



**SCOVILLE-HAVERFIELD**

**17.8165**

Rahmen alleine  
 Frame only  
 cadre seul  
 cuadro suelto

**SCOVILLE-HAVERFIELD**

**17.8164**

bestehend aus: 17.8165 Rahmen, 17.8170 Haken, 17.8174 Valve

consisting of: 17.8165 frame, 17.8170 hook, 17.8174 blade

comprenant de: 17.8165 cadre, 17.8170 crochet, 17.8174 valve

compuesto de: 17.8165 cuadro, 17.8170 gancho, 17.8174 valve



**SCOVILLE**

**17.8174** 64 x 25 mm  
**17.8175** 64 x 50 mm  
**17.8177** 88 x 25 mm

**SCOVILLE**

**17.8178** 41 x 38 mm  
**17.8179** 67 x 44 mm

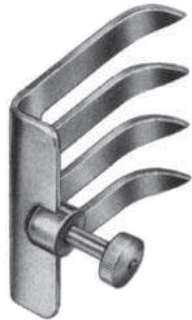

## TAYLOR

17.8181 48 x 51 mm

17.8182 64 x 50 mm

17.8183 80 x 57 mm



## TAYLOR

17.8185 75 x 32 mm

17.8186 100 x 42 mm

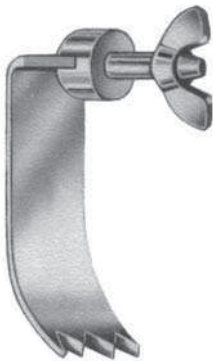

## HIBBS

17.8187 50 x 19 mm

17.8188 50 x 25 mm

17.8189 50 x 50 mm

17.8190 64 x 25 mm

17.8191 64 x 38 mm

17.8192 75 x 25 mm

17.8193 75 x 38 mm

17.8194 75 x 50 mm

17.8195 100 x 25 mm

17.8196 100 x 50 mm



## MEYERDING

17.8201 50 x 25 mm

17.8203 75 x 25 mm

17.8205 90 x 50 mm



**CLOWARD**

**27.1451**

16 cm

Spreizweite	15 mm
opening	15 mm
écartement	15 mm
abertura	15 mm

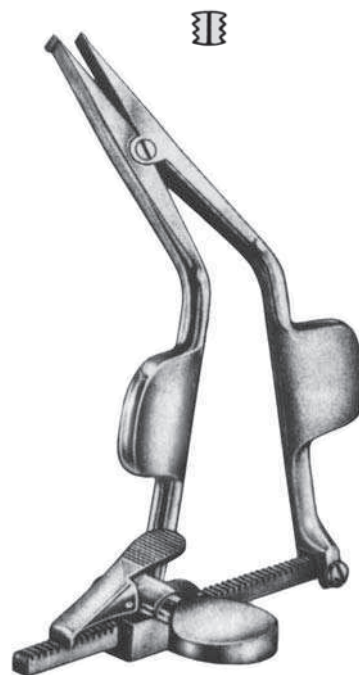

**CLOWARD**

**27.1455**

13 cm

Spreizweite	20 mm
opening	20 mm
écartement	20 mm
abertura	20 mm

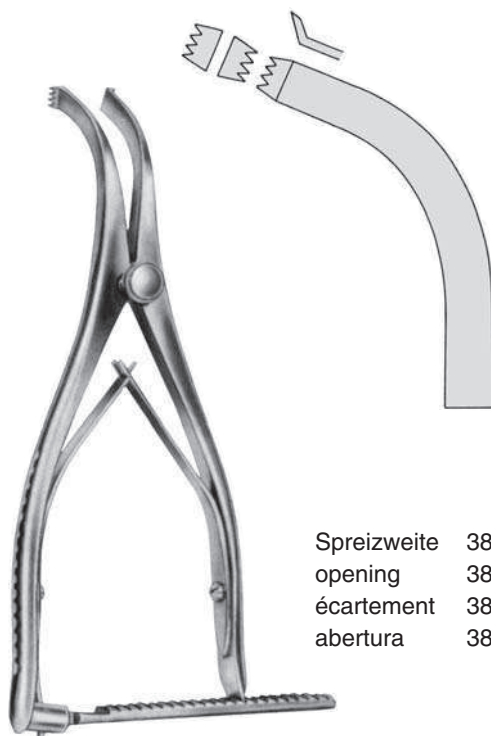

Spreizweite	38 mm
opening	38 mm
écartement	38 mm
abertura	38 mm

**INGE-BABY**

**27.1460**

17 cm



## INGE

**27.1465** 27 cm / 9 mm

**27.1466** 27 cm / 12 mm

Spreizweite 50 mm  
opening 50 mm  
écartement 50 mm  
abertura 50 mm

Ersatzvalve  
Spare valve  
Valve de rechange  
Valva di ricambio



**27.1485** 40 x 12 mm

**27.1486** 50 x 12 mm

**27.1487** 65 x 12 mm

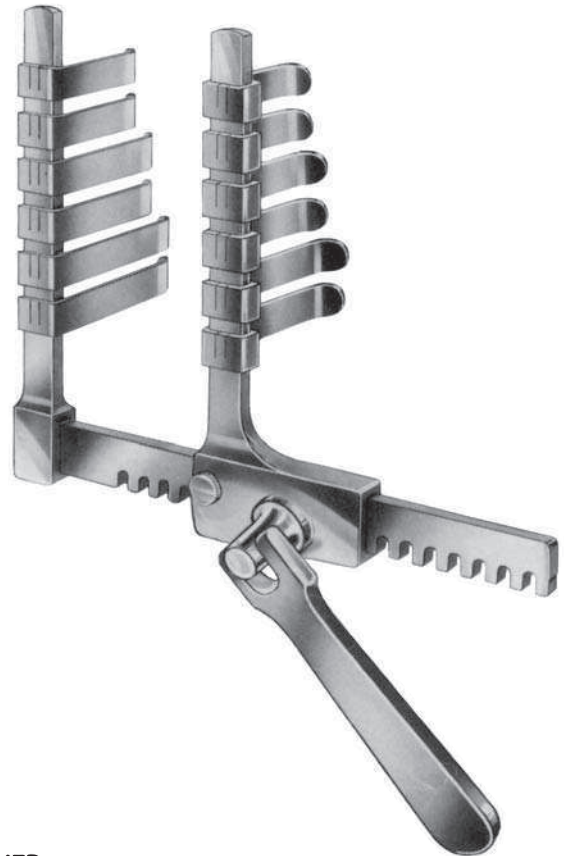

## PRO-MED

**27.1480**

Laminektomiesperrer ALUMINIUM komplett mit je 2 Paar Valven (12 St.) 40, 50, und 65 mm tief und 12 mm breit

Laminectomy retractor, ALUMINIUM, complete with 2 ea. pairs of valves (12 pcs.) 40, 50, and 65 mm deep and 12 mm wide

Ecarteur pour laminectomie ALUMINIUM complet avec 6 pairs de valves (2 pairs de 40 x 12 mm)  
(2 pairs de 50 x 12 mm)  
(2 pairs de 65 x 12 mm)

Separador para laminectomia ALUMINIO completo con 6 pares de valvas (2 pares de 40 x 12 mm)  
(2 pares de 50 x 12 mm)  
(2 pares de 65 x 12 mm)

## PRO-MED







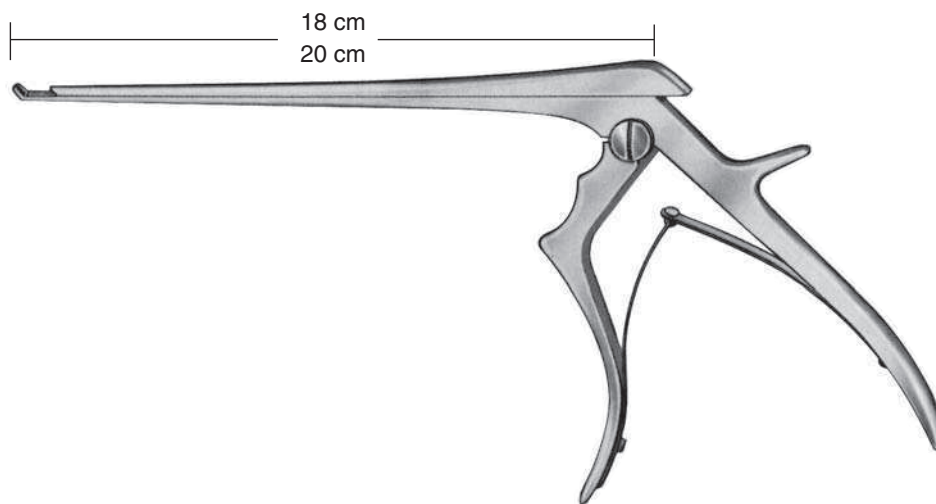













**27.1481**

Laminektomiesperrer alleine  
Laminectomy retractor only (without valves)  
Ecarteur seul, sans valves  
Separador suelto, sin valvas

mit dünner Fußplatte  
 with thin footplate  
 avec pied mince  
 con lamina delgado



**FERRIS-SMITH-KERRISON**

	90°	18 cm		20 cm
		<b>27.1561</b>	1 mm	<b>27.1561-20</b>
		<b>27.1562</b>	2 mm	<b>27.1562-20</b>
		<b>27.1563</b>	3 mm	<b>27.1563-20</b>
		<b>27.1564</b>	4 mm	<b>27.1564-20</b>
		<b>27.1565</b>	5 mm	<b>27.1565-20</b>
	40°			
		<b>27.1581</b>	1 mm	<b>27.1581-20</b>
		<b>27.1582</b>	2 mm	<b>27.1582-20</b>
		<b>27.1583</b>	3 mm	<b>27.1583-20</b>
		<b>27.1584</b>	4 mm	<b>27.1584-20</b>
		<b>27.1585</b>	5 mm	<b>27.1585-20</b>