

**PRO-MED**

Magen, Darm, Mastdarm  
Leber, Galle, Niere  
Urologie  
Gynäkologie, Geburtshilfe

Stomach, Intestines, Rectum  
Liver, Gall, Kidneys  
Urology  
Gynecology, Obstetrics

Estomac, Intestines, Rectum  
Foe, Bile, Reins  
Urologie  
Gynécologie, Accouchement

Estómago, Intestinos, Recto  
Higado, Bilis, Riñón  
Urología  
Ginecología, Obstetrica

**PRO-MED**

MAGEN, DARM, MASTDARM

STOMACH, INTESTINES, RECTUM

ESTOMAC, INTESTIN, RECTUM

ESTOMAGO, INTESTINOS, RECTO



**ALLIS-BABY**

48.0004 13 cm, 4 x 5  
 48.0006 14 cm, 4 x 5



**ALLIS**

  
**48.0010**  
 15 cm, 4 x 5

  
**48.0011**  
 15 cm, 5 x 6

**48.0014**  
 19 cm, 5 x 6

**48.0016**  
 23 cm, 5 x 6

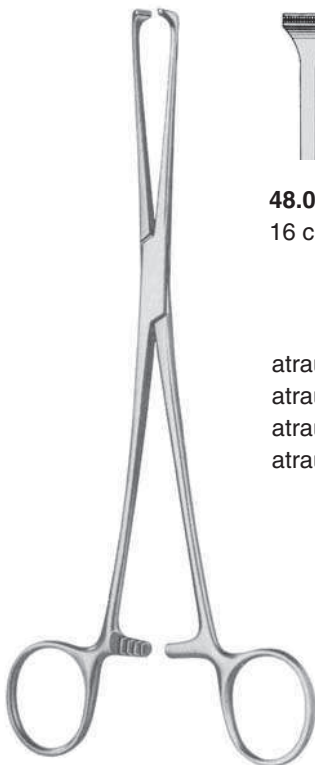

**ALLIS**

  
**48.0020**  
 16 cm

  
**48.0024**  
 20 cm

  
**48.0028**  
 25 cm

atraumatisch  
 atraumatic  
 atraumatique  
 atraumática



**ALLIS-ADAIR**  
**48.0030** 15,5 cm



**JUDD-ALLIS**  
 48.0032 15 cm  
 48.0034 19 cm



**THOMS-ALLIS**  
 48.0038  
 20 cm, 6 x 7

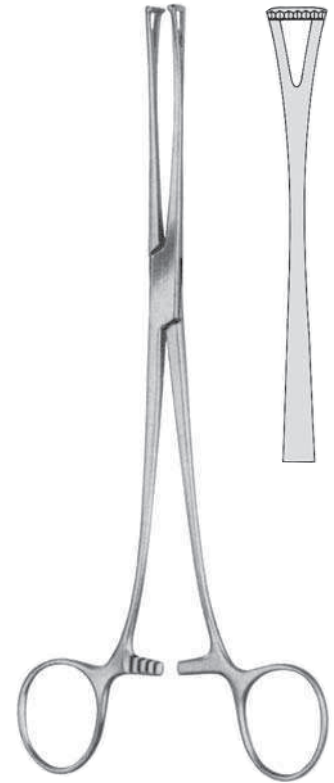

**LOCKWOOD**  
 48.0040 19,5 cm

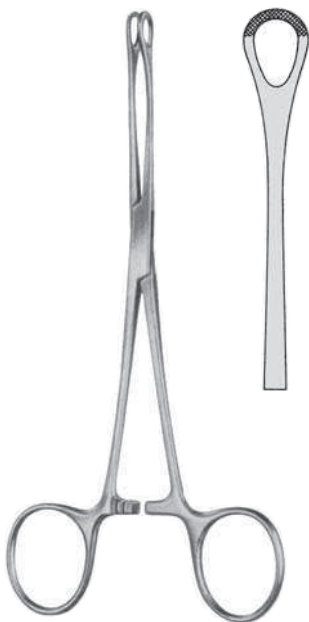

**WILLIAMS**  
 48.0045 16,5 cm



**BABCOCK**



**48.0062**  
 16 cm



**48.0064**  
 18 cm

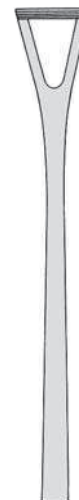

**48.0066**  
 20 cm

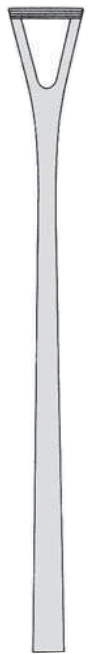

**48.0068**  
 24 cm



**BABCOCK**



**48.0072**  
16 cm  
**PROME(DUR)**

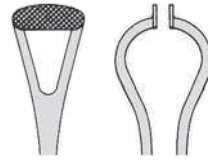

**48.0076**  
20 cm  
**PROME(DUR)**

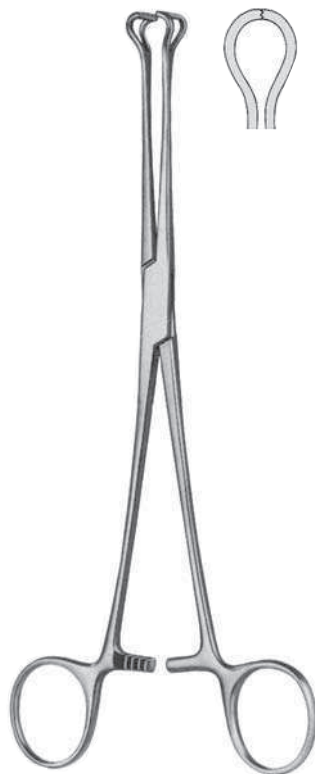

**BABCOCK-DEBAKEY**



**48.0082**  
16 cm



**48.0086**  
20 cm

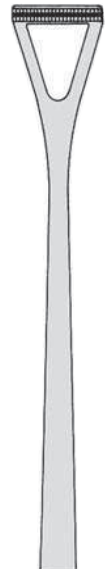

**48.0088**  
23 cm



**DUVAL**

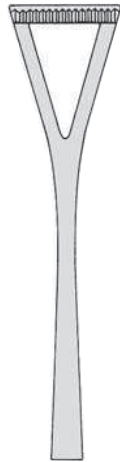

**48.0090**  
18 cm / 14 mm  
**48.0092**  
20 cm / 14 mm

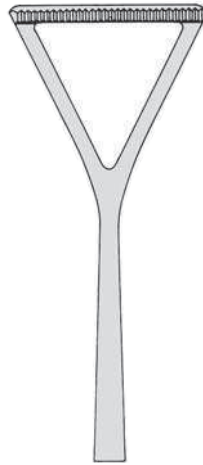

**48.0094**  
20 cm / 25 mm  
**48.0098**  
23 cm / 25 mm



**DUVAL**



**48.0099**  
20 cm / 15 mm  
**PROMEDUR**



**DOYEN**



**48.0102**  
18 cm



**48.0103**  
18 cm



**DOYEN**



**48.0104** 21 cm  
**48.0106** 23 cm

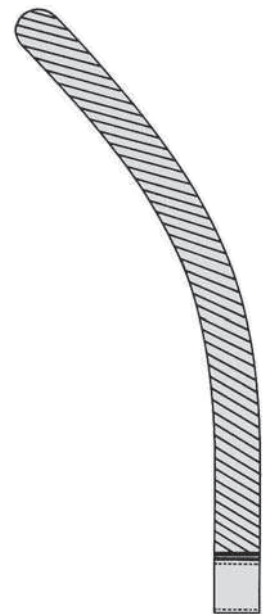

**48.0105** 21 cm  
**48.0107** 23 cm



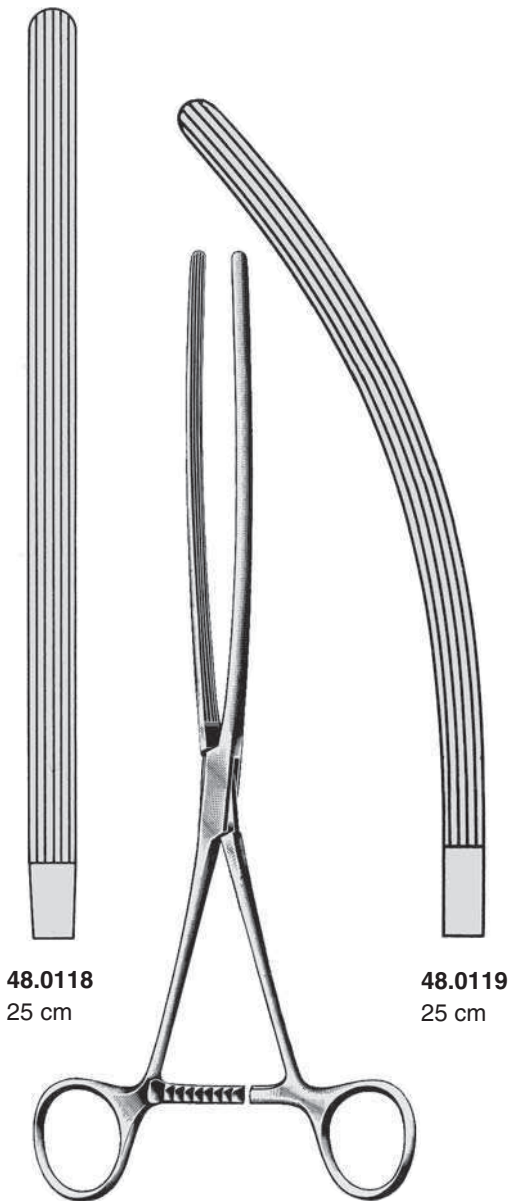

**MAYO-ROBSON**

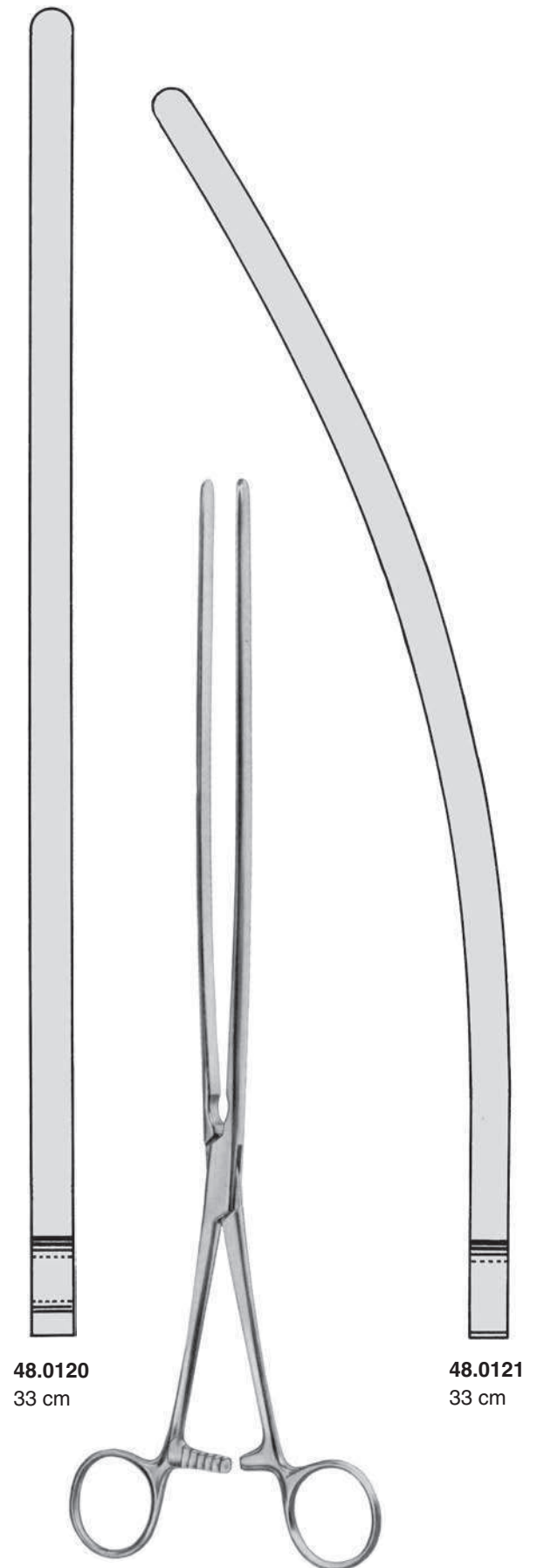

**SCUDDER**



**BRUNNER**  
48.0125 23 cm



**FEHLAND**  
48.0126 24 cm



**48.0130**  
26,5 cm / 30 mm



**48.0131**  
26,5 cm / 60 mm



**48.0132**  
26,5 cm / 75 mm

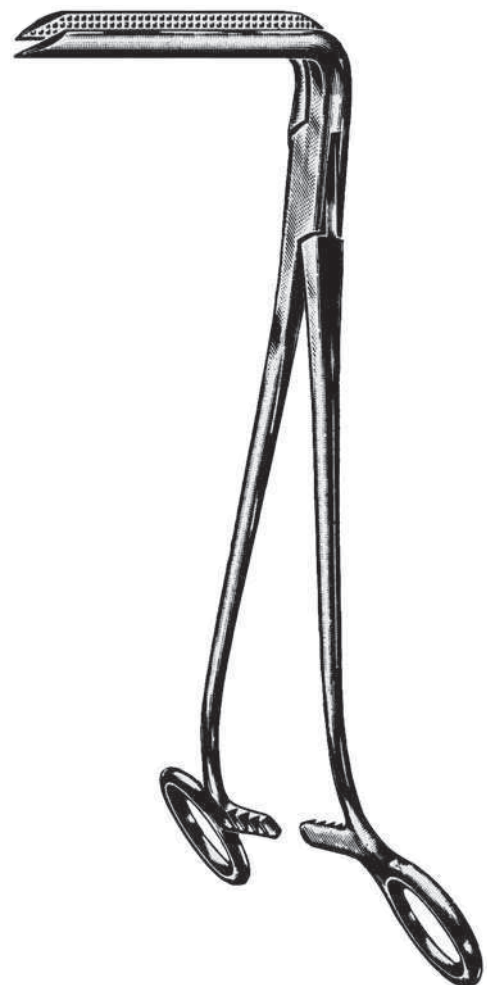

**BEST**



**LANE**  
48.0140 30 cm

**LANE**  
48.0141 30 cm



48.0150 13 cm  
 48.0152 16 cm

DOYEN-DEBAKEY



48.0151 13 cm  
 48.0153 16 cm

DOYEN-DEBAKEY

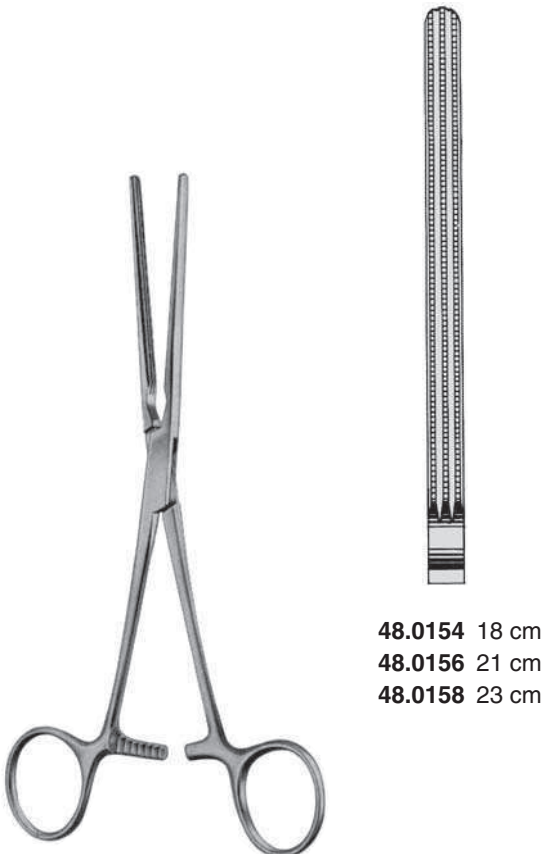

48.0154 18 cm  
 48.0156 21 cm  
 48.0158 23 cm

DOYEN-DEBAKEY



48.0155 18 cm  
 48.0157 21 cm  
 48.0159 23 cm

DOYEN-DEBAKEY



**KOCHER-DEBAKEY**

48.0160 22 cm  
48.0162 25 cm  
48.0164 28 cm



**KOCHER-DEBAKEY**

48.0161 22 cm  
48.0163 25 cm  
48.0165 28 cm



**HAYES-DEBAKEY**



**48.0170**  
26 cm / 55 mm

**48.0172**  
28 cm / 85 mm



**FEHLAND-DEBAKEY**  
**48.0180** 24 cm



**BUIE**  
48.0300 21 cm



**FERGUSSON**

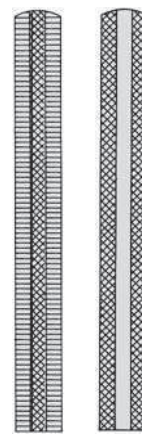

**48.0312** 20 cm

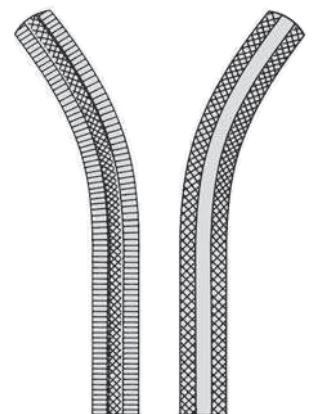

**48.0313** 20 cm



**48.0500** 18 cm  
 ohne stift  
 without pin  
 sans broche  
 sin espiga

**48.0510** 18 cm  
 mit stift  
 with pin  
 avec broche  
 con espiga



**PAYR-BABY**



**PAYR**



**48.0501** 20 cm  
 ohne stift  
 without pin  
 sans broche  
 sin espiga

**48.0511** 20 cm  
 mit stift  
 with pin  
 avec broche  
 con espiga



**48.0502** 28 cm  
 ohne stift  
 without pin  
 sans broche  
 sin espiga

**48.0512** 28 cm  
 mit stift  
 with pin  
 avec broche  
 con espiga

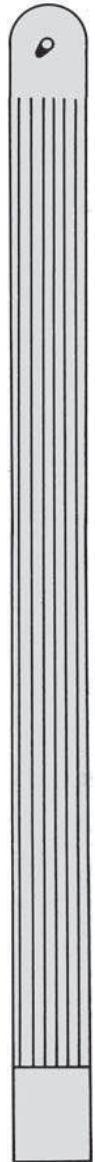

**48.0503** 35 cm  
 ohne stift  
 without pin  
 sans broche  
 sin espiga

**48.0513** 35 cm  
 mit stift  
 with pin  
 avec broche  
 con espiga



**DEMARTEL-WOLFSON**



**48.0530** 5 cm  
Satz zu 3 Klemmen  
Set of 3 clamps  
Jeu de 3 clamps  
Juego de 3 clamps



**48.0532** 7,5 cm  
Satz zu 3 Klemmen  
Set of 3 clamps  
Jeu de 3 clamps  
Juego de 3 clamps



**48.0534** 10 cm  
Satz zu 3 Klemmen  
Set of 3 clamps  
Jeu de 3 clamps  
Juego de 3 clamps

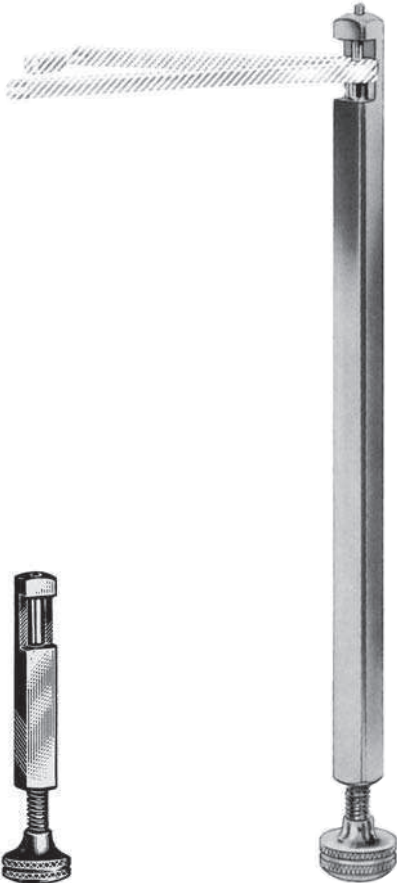

**DEMARTEL-  
WOLFSON**  
48.0536 8,5 cm

**DEMARTEL-  
WOLFSON**  
48.0537 23 cm



**DEMARTEL-  
WOLFSON**  
48.0538 26 cm



**STONE**  
48.0550 15,5 cm



**STONE-WATT**  
48.0555 7,5 cm  
48.0556 10,0 cm



**STONE-WATT**  
48.0557

Magen- und Darmnähhapparat  
Stomach and intestinal suturing apparatus  
Appareil à sutures stomacales et intestinales  
Aparato para suturar estomago y intestinos

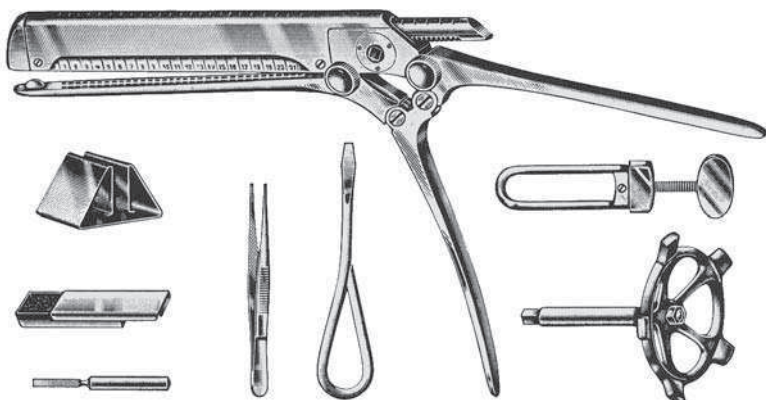

**VON PETZ**  
48.0600 compl.



300 Stück  
300 ea.  
300 pièces  
300 c/u

**48.0620**



**BENSON**  
48.0700  
15 cm



**SIMS**  
**48.1000**  
16 cm

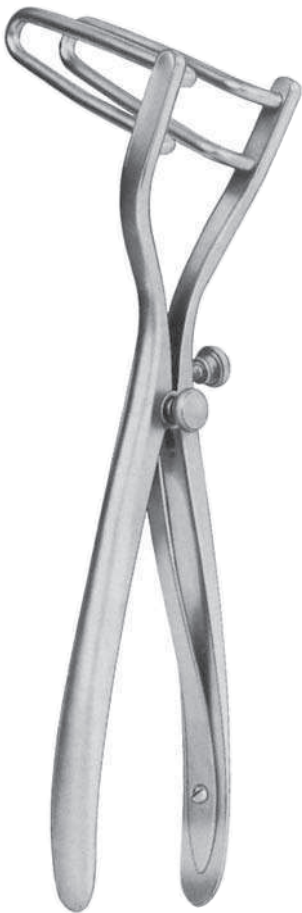
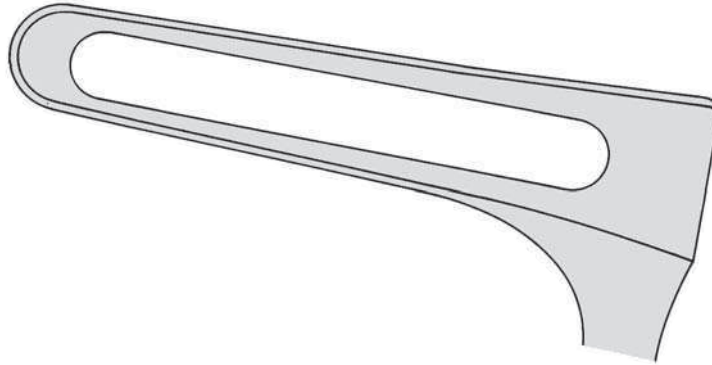

**SCHULZE-BERGMANN**  
22 cm

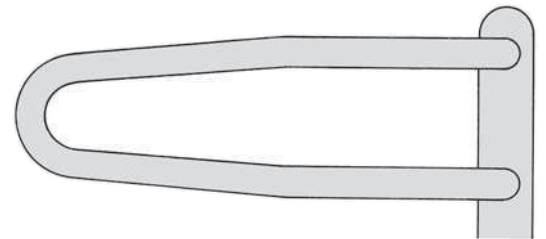

**48.1005** 65 mm

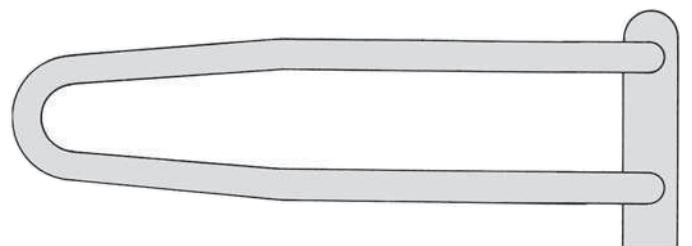

**48.1006** 85 mm

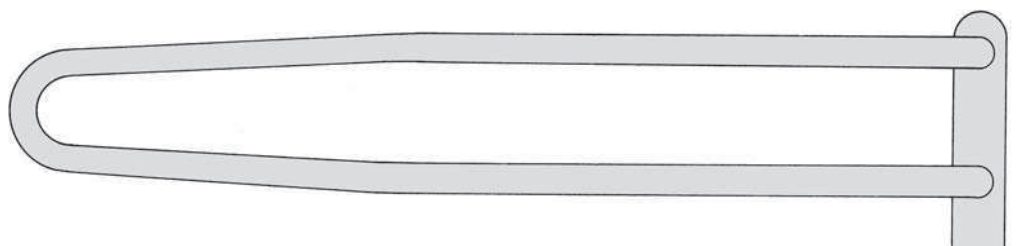

**48.1007** 125 mm

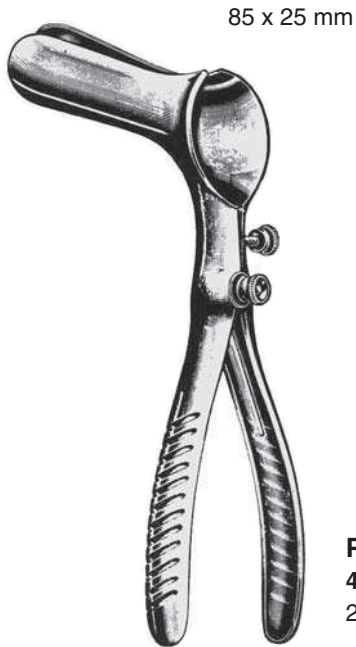

85 x 25 mm

**PRATT**  
 48.1020  
 21,5 cm



90 x 15 mm

**MATHIEU**  
 48.1030  
 19,5 cm



90 x 17 mm

**BODENHAMMER**  
 48.1040  
 15,5 cm

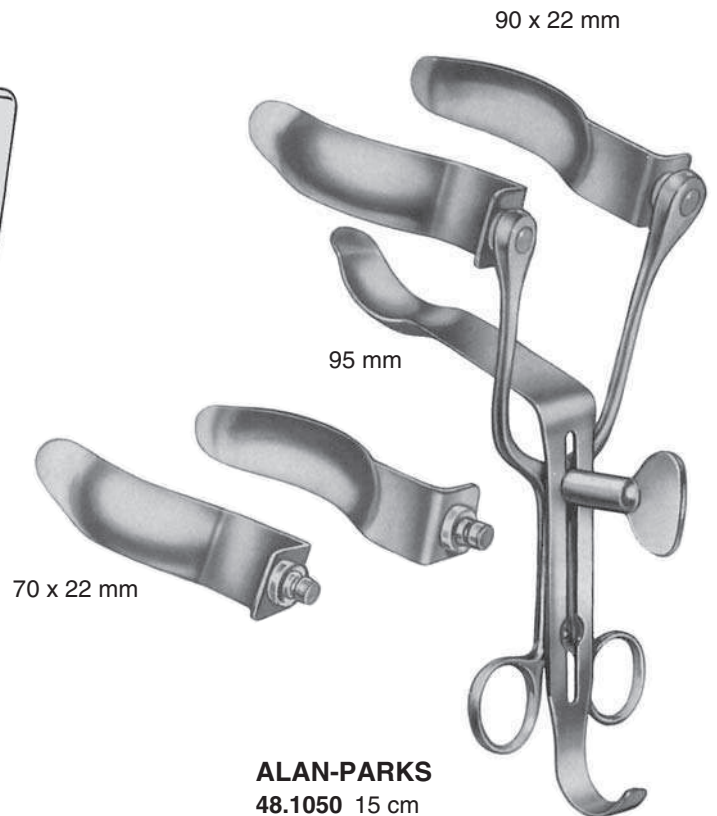

90 x 22 mm

95 mm

70 x 22 mm

**ALAN-PARKS**  
 48.1050 15 cm  
 komplett  
 complete  
 complet  
 completo



**CZERNY**  
48.1055  
22 cm

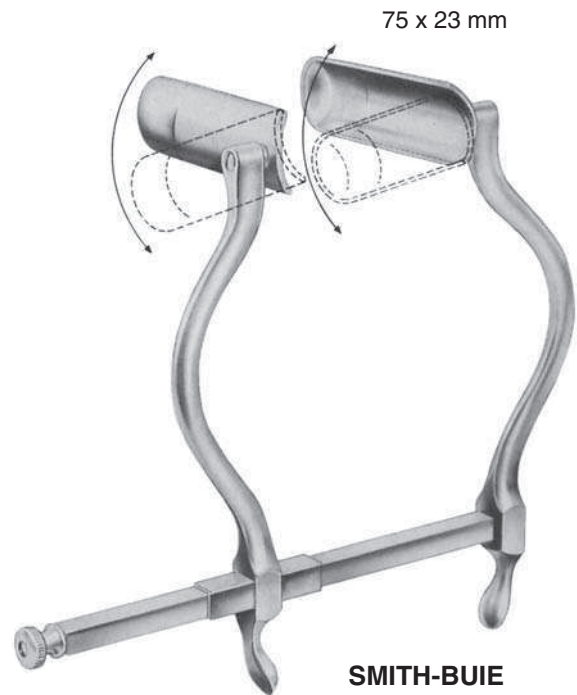

**SMITH-BUIE**  
48.1060  
15 cm



**BARR**  
48.1070 17 cm

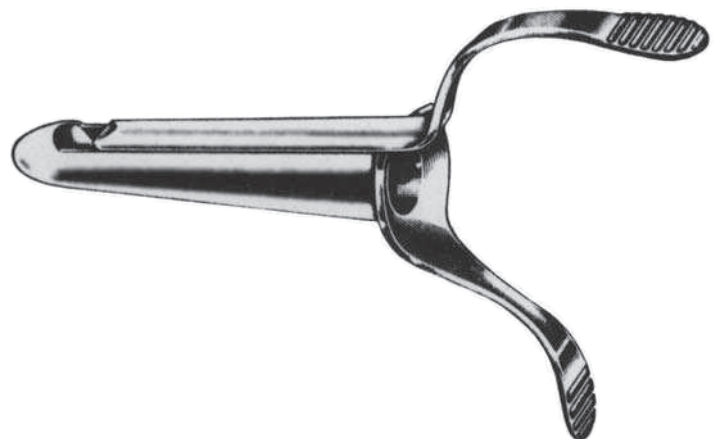

**BRINKERHOFF**  
48.1100 13 - 25 mm Ø / 89 mm  
48.1102 13 - 25 mm Ø / 102 mm  
48.1104 19 - 32 mm Ø / 114 mm



**ROSCHKE**  
48.1130

48.1132  
mit Kaltlicht / with fibre optic  
avec fibre optique / con fibra de óptico



**KELLY**  
48.1200 50 x 21 mm  
48.1202 50 x 27 mm



**KELLY**  
48.1210 50 x 22 mm  
48.1212 100 x 22 mm  
48.1214 145 x 22 mm  
48.1216 200 x 22 mm



**HIRSCHMANN**  
 48.1230 65 x 16 mm  
 48.1232 65 x 19 mm  
 48.1234 65 x 22 mm



**BENSAUDE**  
 48.1250 70 x 19 mm  
 48.1252 70 x 22 mm



**FANSLER-IVES**  
 48.1255 22 mm



**FANSLER-IVES**  
 48.1256 22 mm  
 mit Kaltlicht  
 with cold light  
 avec lumière froide  
 con luz fria

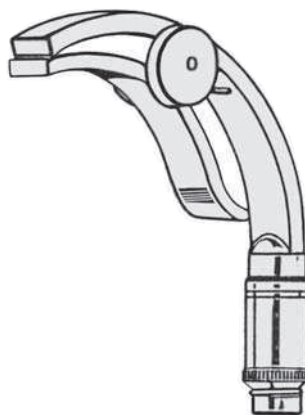

**55.3600**  
 Kaltlichtklammer für Proktoskope mit  
 Kombi-Stecker für alle Systeme  
 Coldlight clip for proctoscopes with  
 combi-plug for all systems  
 Clip lumière froide pour proctoscopes  
 avec fiche utilisable pour tous systèmes  
 Clip luz fria para proctoscopios con  
 clavija para todos sistemas

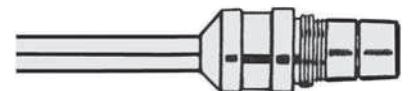

**55.3607**  
 Grundstecker für System ACM  
 Basic plug for system ACM  
 Fiche pour système ACM  
 Clavija para sistema ACM



**55.3608**  
 Wolf, HSW



**55.3609**  
 Storz, Winter, Olympus



**STRAUSS**  
**48.1260**

Rektoskop  
 Rectoscope set  
 Rectoscope  
 Juego de rectoscopios

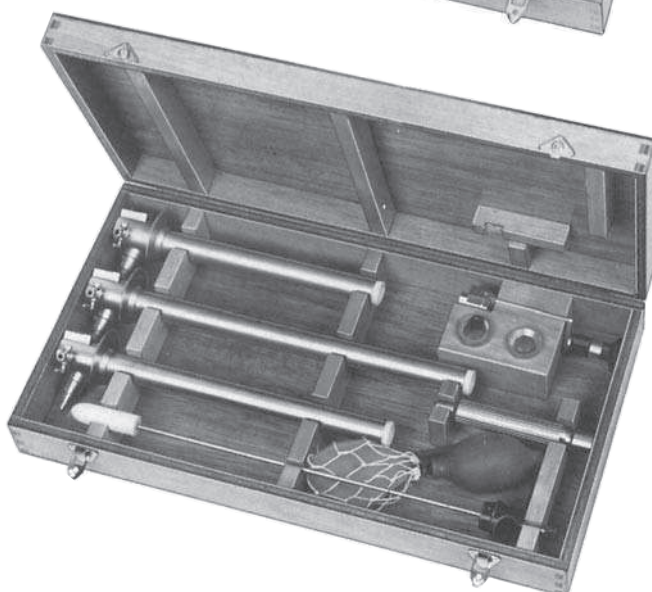

**STRAUSS**  
**48.1270**

Rektoskop mit Kaltlicht  
 Rectoscope set with cold light  
 Rectoscope avec lumière froide  
 Juego de rectoscopios con luz fria



**48.1301**  
 #1

**PRATT**  
 21,5 cm



**48.1302**  
 #2

Cystikus-Häkchen  
 Crypt hooks  
 Crochets à fistules  
 Ganchos para fistulas



**48.1303**  
 #3



Fistelsonde  
 Fistula probe  
 Sonde pour fistules  
 Sonda para fistulas

**BUIE**  
**48.1310**  
 16 cm



Rektalschnürer  
Rectal snares  
Serre-nœuds  
Cierra-nudos



**WESTON**  
48.1400  
30 cm

**NORWOOD**  
48.1410  
30 cm



**48.1419**  
12 Stück / 12 pieces  
12 pieces / 12 piezas



**BUIE**  
48.1420 30 cm

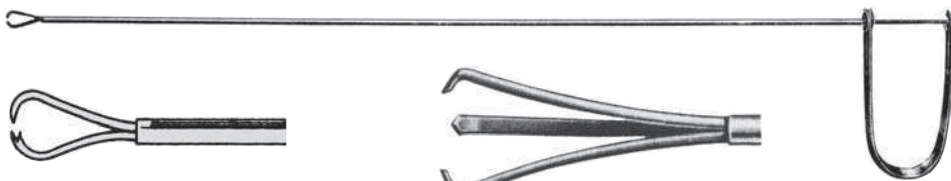

**48.1602**  
38 cm

**48.1603**  
38 cm

Tamponhalter / Swab holders  
Portes-coton / Portas-algodones



**KATZENSTEIN**  
48.1621 9 cm

Rektumkanüle / Rectal cannula  
Canule rectale / Canula rectal

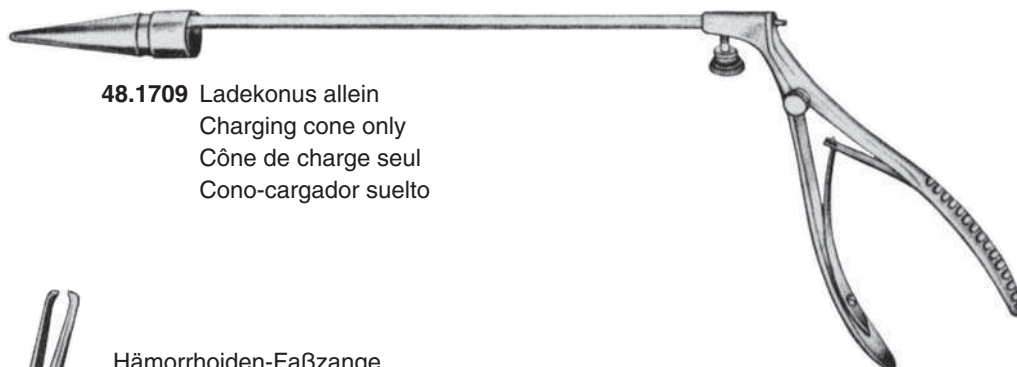

**48.1709** Ladekonus allein  
Charging cone only  
Cône de charge seul  
Cono-cargador suelto



Hämorrhoiden-Faßzange  
Haemorrhoidal forceps  
Pince pour saisir les hémorroïdes  
Pinza hemorroidal

**MCGIVNEY**  
**48.1702**  
19cm

**MCGIVNEY**  
**48.1700**

Hämmorrhoidal Ligator mit Ladeaufsatz und 100 Gummiringen Nr. 48.1715

Haemorrhoidal ligator with loading attachment and 100 ligature rubber rings No. 48.1715

Ligateur pour hémorroïdes avec embout conique pour dilater les anneaux et 100 anneaux de caoutchouc à ligatures No. 48.1715

Ligador hemorroidal con aditamiento de carga y 100 anillos de goma para ligaduras No. 48.1715

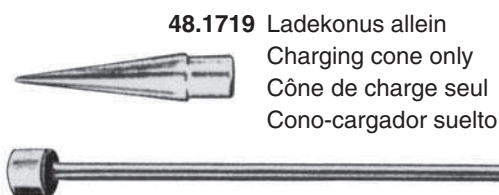

**48.1719** Ladekonus allein  
Charging cone only  
Cône de charge seul  
Cono-cargador suelto



**RUDD**  
**48.1715**  
100 Stück / 100 pieces  
100 pieces / 100 piezas

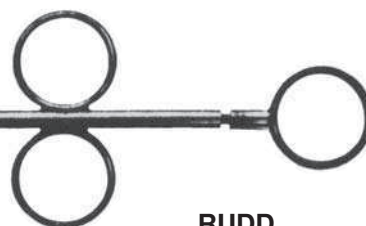

**RUDD**  
**48.1710**

Hämmorrhoidal Ligator mit Ladeaufsatz und 100 Gummiringen Nr. 48.1715

Haemorrhoidal ligator with loading attachment and 100 ligature rubber rings No. 48.1715

Ligateur pour hémorroïdes avec embout conique pour dilater les anneaux et 100 anneaux de caoutchouc à ligatures No. 48.1715

Ligador hemorroidal con aditamiento de carga y 100 anillos de goma para ligaduras No. 48.1715

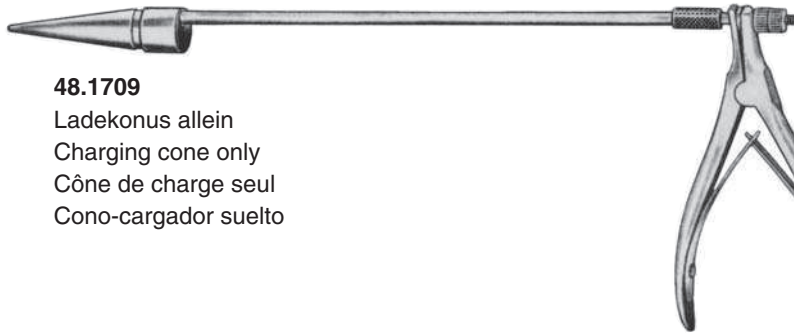

**48.1709**

Ladekonus allein  
Charging cone only  
Cône de charge seul  
Cono-cargador suelto

Hämorrhoidal Ligator mit Ladeaufsatz und 100 Gummiringen Nr. 48.1715

Haemorrhoidal ligator with loading attachment and 100 ligature rubber rings No. 48.1715

Ligateur pour hémorroïdes avec embout conique pour dilater les anneaux et 100 anneaux de caoutchouc à ligatures No. 48.1715

Ligador hemorroidal con aditamiento de carga y 100 anillos de goma para ligaduras No. 48.1715

**FORD-DIXON**

**48.1730**

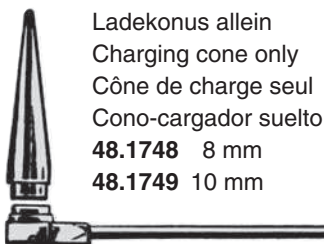

Ladekonus allein  
Charging cone only  
Cône de charge seul  
Cono-cargador suelto

**48.1748** 8 mm

**48.1749** 10 mm

Hämorrhoidal-Saugligator mit Ladeaufsatz und 100 Ligatur-Gummiringen Nr. 48.1715

Haemorrhoidal suction ligator with loading attachment and 100 ligature rubber rings No. 48.1715

Ligateur aspirant pour hémorroïdes avec embout conique pour dilater les anneaux et 100 anneaux de caoutchouc à ligatures No. 48.1715

Ligador aspirante hemorroidal con aditamiento de carga y 100 anillos de goma para ligaduras No. 48.1715

**LURZ**

**48.1740** 8 mm

**48.1742** 10 mm

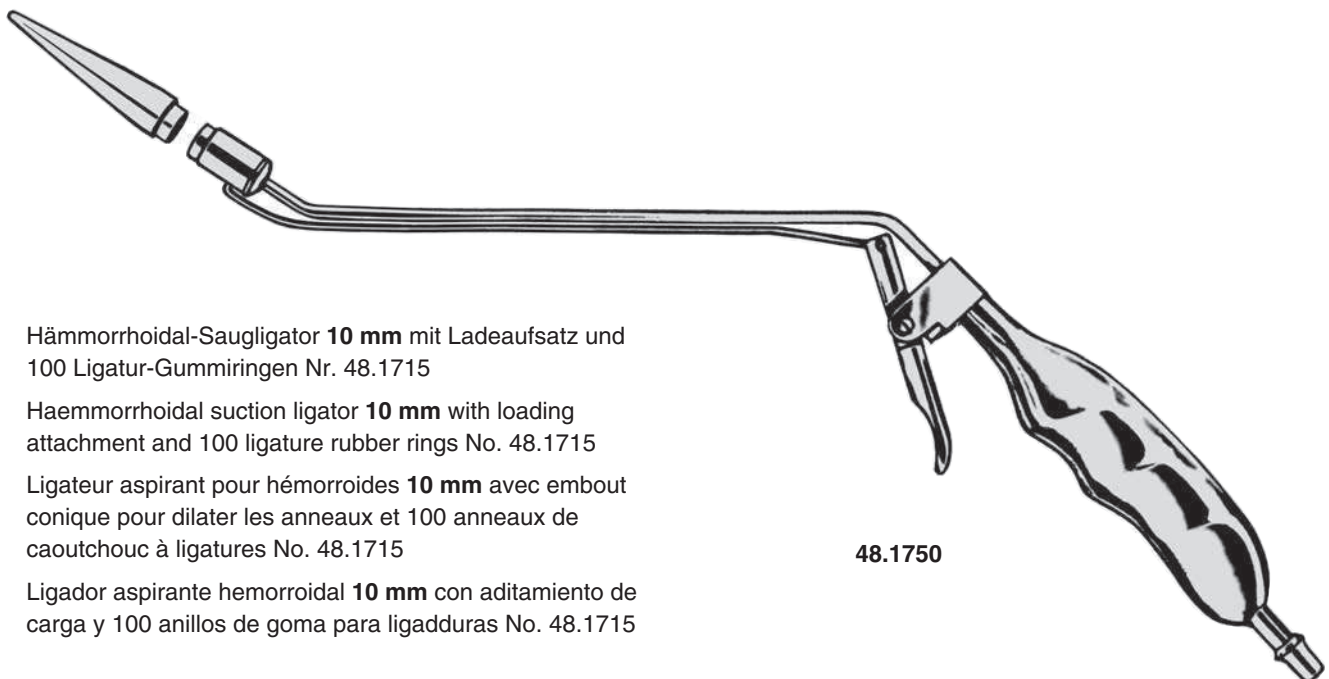

Hämorrhoidal-Saugligator **10 mm** mit Ladeaufsatz und 100 Ligatur-Gummiringen Nr. 48.1715

Haemorrhoidal suction ligator **10 mm** with loading attachment and 100 ligature rubber rings No. 48.1715

Ligateur aspirant pour hémorroïdes **10 mm** avec embout conique pour dilater les anneaux et 100 anneaux de caoutchouc à ligatures No. 48.1715

Ligador aspirante hemorroidal **10 mm** con aditamiento de carga y 100 anillos de goma para ligaduras No. 48.1715

**48.1750**



**YEOMAN**



#1

**48.2001** 28 cm  
**48.2011** 35 cm  
**48.2015** 42 cm

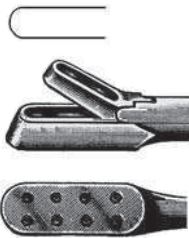

#2

**48.2002** 28 cm  
**48.2012** 35 cm  
**48.2016** 42 cm

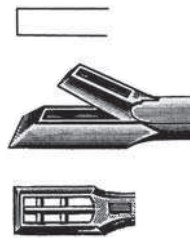

#3

**48.2003** 28 cm  
**48.2013** 35 cm  
**48.2017** 42 cm

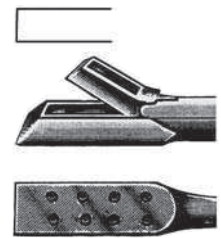

#4

**48.2004** 28 cm  
**48.2014** 35 cm  
**48.2018** 42 cm

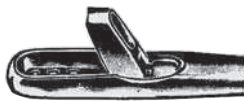
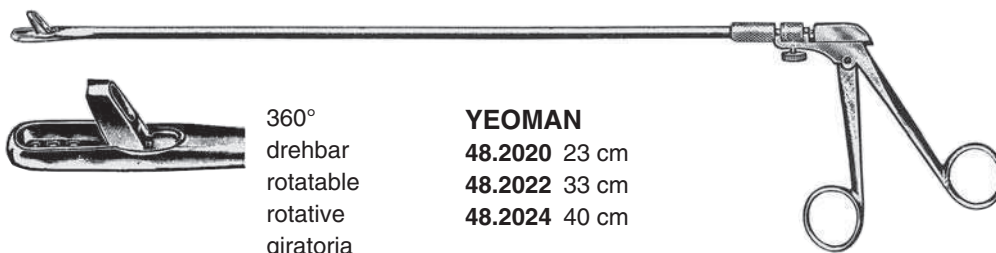

360°  
 drehbar  
 rotatable  
 rotative  
 giratoria

**YEOMAN**

**48.2020** 23 cm  
**48.2022** 33 cm  
**48.2024** 40 cm

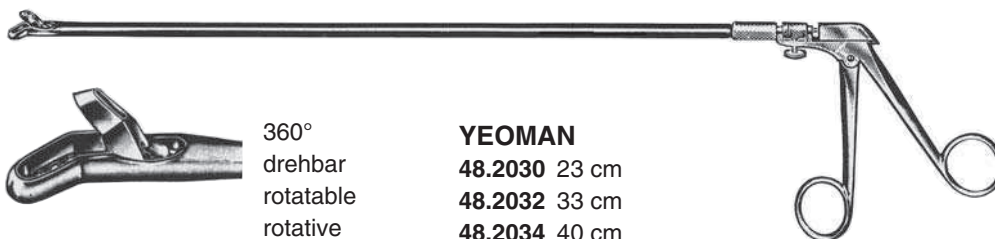

360°  
 drehbar  
 rotatable  
 rotative  
 giratoria

**YEOMAN**

**48.2030** 23 cm  
**48.2032** 33 cm  
**48.2034** 40 cm

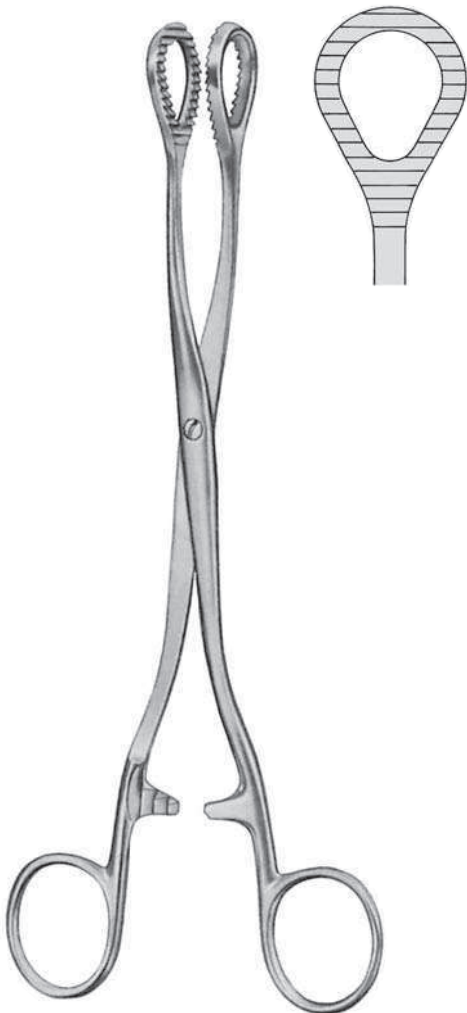

**HEYWOOD-SMITH**  
48.2200 20 cm

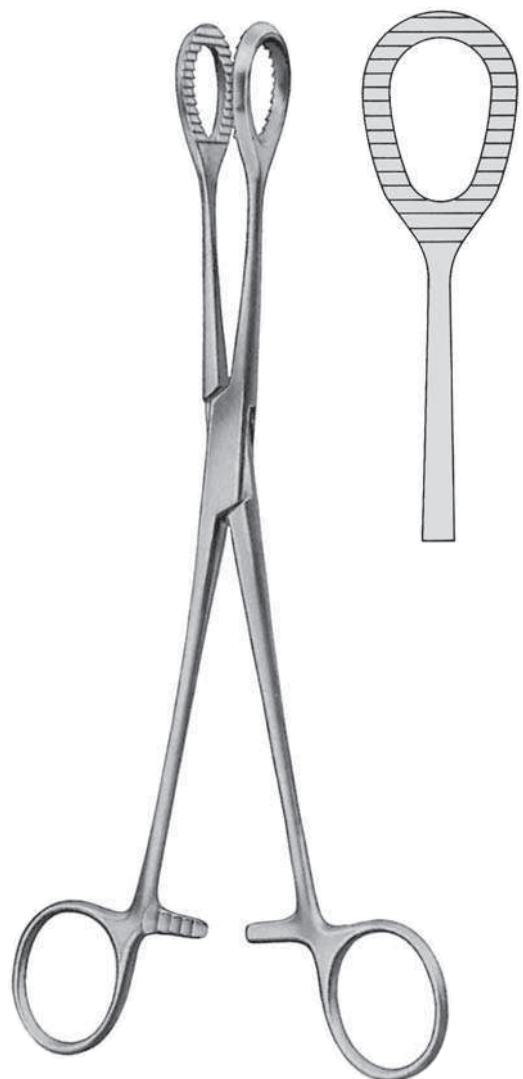

**HEYWOOD-SMITH**  
48.2202 21 cm