

MUND, ZUNGE, TONSILLEKTOMIE  
MOUTH, THROAT, TONSILLECTOMY  
BOUCHE, LANGUE, AMYGDALECTOMIE  
BOCA Y LENGUA, AMIGDALECTOMIA  
BOCCA, LINGUA, TONSILLECTOMIA

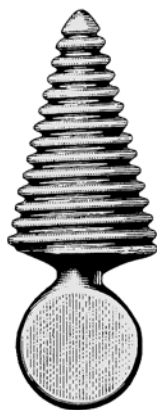



**MAUNDER**  
34.0001  
10 cm



**DENHART**  
34.0004  
12 cm

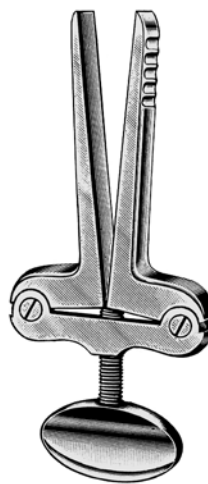

**HEISTER**  
34.0005  
13 cm



**DOYEN-JANSEN**  
34.0010  
12 cm

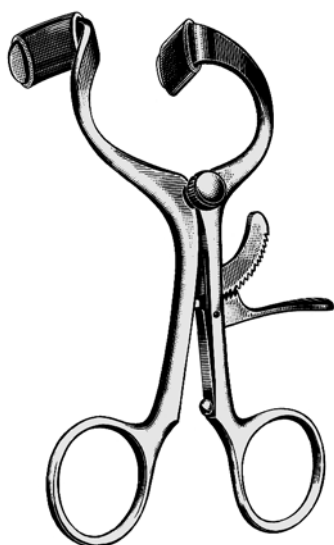

**DOYEN-JANSEN**  
34.0011  
14 cm

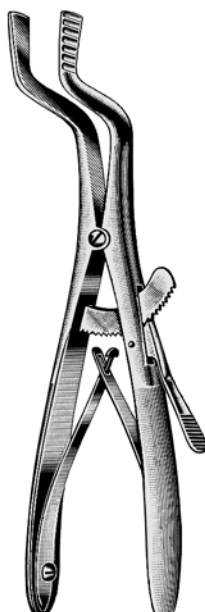

**ROSER-KOENIG**  
34.0016 16 cm  
34.0019 19 cm



**34.0020**  
14,5 cm



**34.0021**  
14,5 cm



**UNIV. MINNESOTA**  
34.0024  
14 cm



**KROENIG**  
34.0025  
15 cm



**MAYO**  
34.0027  
17 cm



**BUCHWALD**  
34.0028  
18 cm



**BRUENINGS**  
34.0029  
19 cm



**ANDREW**  
34.0031  
11 cm



**DOYEN**  
34.0033 13 cm  
34.0036 16 cm

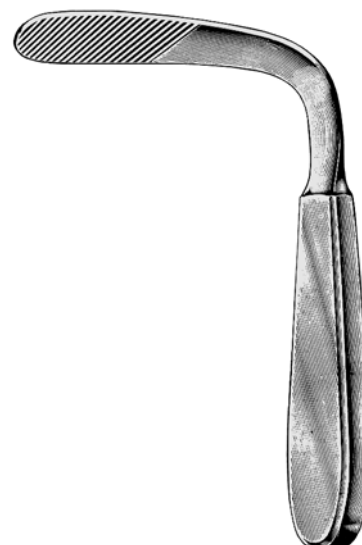

**TOBOLD**  
34.0044  
14,5 cm

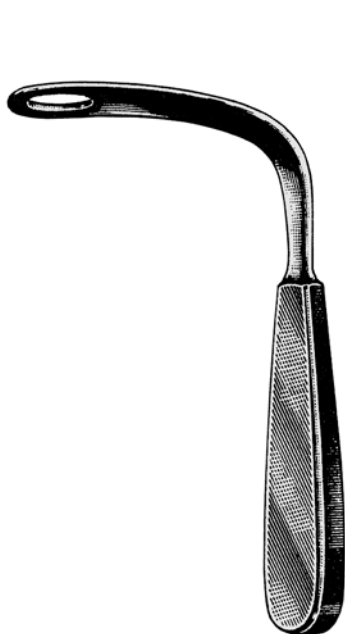

**BOSWORTH**  
34.0045  
14,5 cm



**HARTMANN**  
34.0046  
14,5 cm

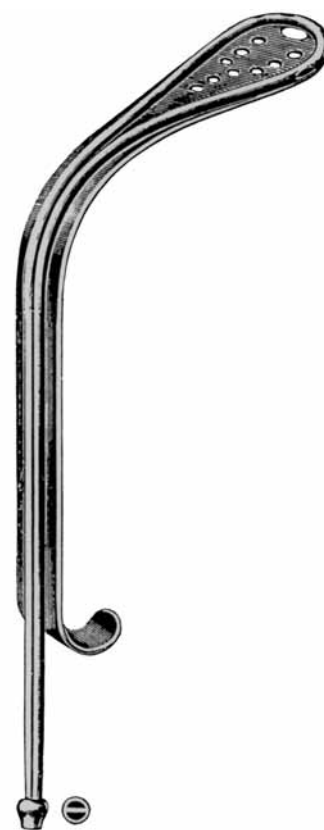

**LE MEE**  
34.0047  
20 cm

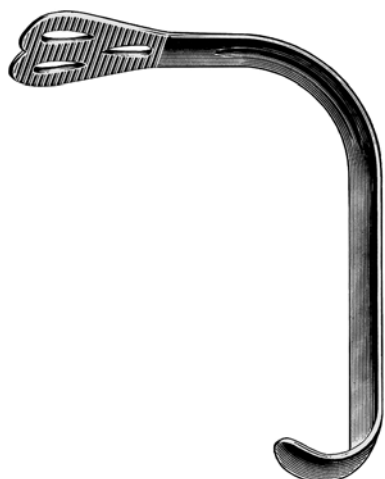

**WIEDER**



**34.0050**  
#1 35 mm



**34.0051**  
#2 40 mm



**LACK**  
34.0052  
13 mm  
f. Kinder / for children /  
pour enfants /  
para niños / per bambini

**34.0053**  
19 mm  
f. Jugendliche /  
for juveniles / pour adolescents /  
para adolescentes / per giovane

**34.0054**  
22 mm  
f. Erwachsene / for adults /  
pour adultes / para adultos /  
per adulti



**34.0055**  
 15 cm  
 Plastik  
 plastic  
 matière synthétique  
 plástico  
 sintetico

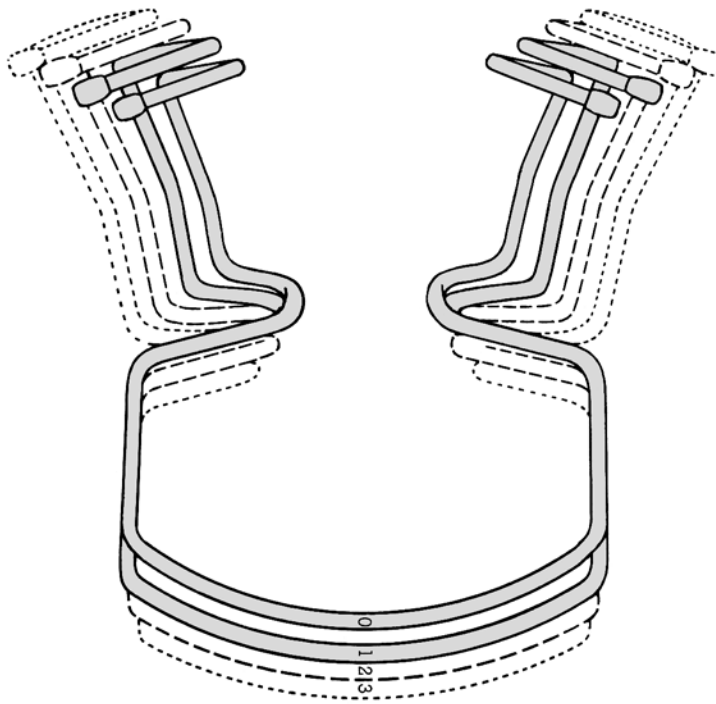

**ORINGER**  
**34.0056** Fig. 0, 9,5 cm, 95 mm  
 für Kinder / for children / pour enfants /  
 para niños / per bambini  
**34.0057** Fig. 1, 10 cm, 110 mm  
**34.0058** Fig. 2, 10,5cm, 115 mm  
**34.0059** Fig. 3, 11 cm, 120 mm



**STERNBERG**  
**34.0061** 12 cm  
**34.0062** 14 cm  
**34.0063** 16 cm

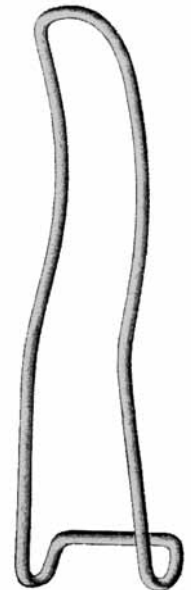

**STERNBERG**  
**34.0064** 14 cm  
**34.0065** 16 cm  
**34.0066** 18 cm

**34.0060**  
 Satz / Set / Jeu / Juego / Set Fig. 1-3

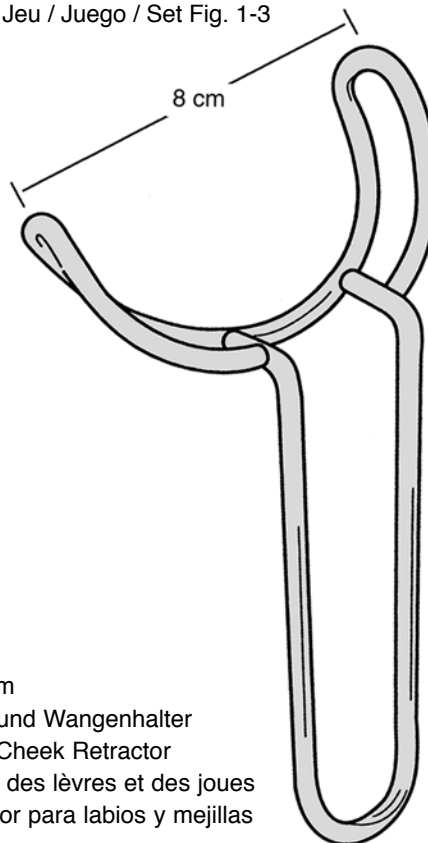

**34.0076**  
 14 x 8 cm  
 Lippen- und Wangenhalter  
 Lip and Cheek Retractor  
 Ecarteur des lèvres et des joues  
 Separador para labios y mejillas  
 ital...



**34.0070**  
 19 cm

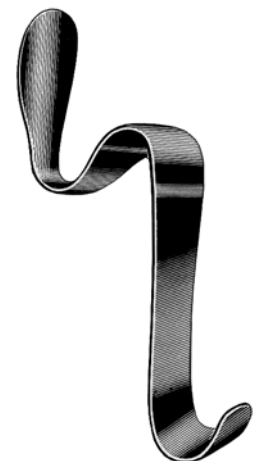

**BISHOP**  
**34.0080**  
 13 cm

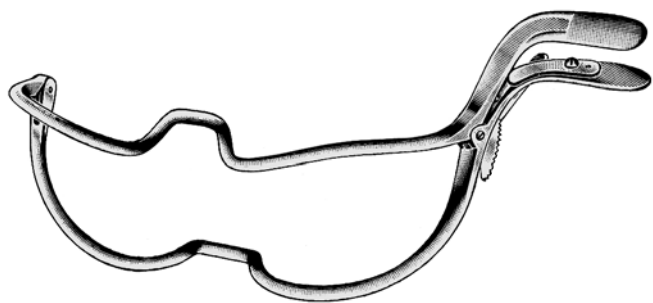

**JENNINGS**  
34.0100 9 cm  
34.0101 11 cm  
34.0102 13 cm  
34.0103 15 cm

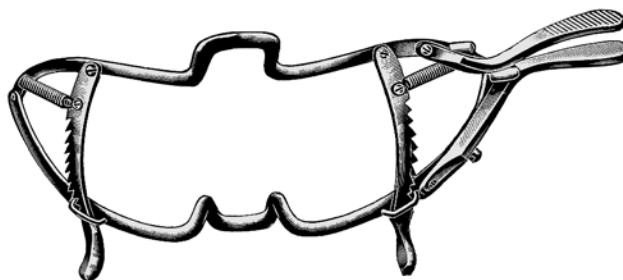

**WHITEHEAD**  
34.0120 9 cm  
34.0121 11 cm  
34.0122 13 cm  
34.0123 15 cm

alle Rahmen und Zungendrucker sind untereinander austauschbar  
all frames and tongue blades are interchangeable  
Tous les cadres et abaisses-langues sont interchangeables  
Todos los bastidores y bajalenguas son intercambiables  
Tutti i telai ed abbassalingua sono intercambiabili



**34.0149**  
Ersatz Silikon-Einlage /  
Spare silicone insert / Plaque  
de rechange en silicone /  
Plantilla de silicona de repu-  
esto / Plastre di ricambio en  
solicone



**34.0142**  
21 x 25 mm



**34.0143**  
23 x 65 mm

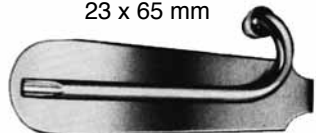

**34.0144**  
24 x 80 mm

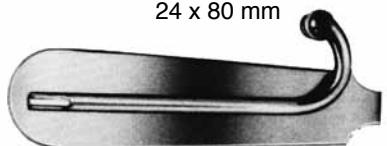

**34.0145**  
25 x 93 mm



**34.0146**  
26 x 108 mm

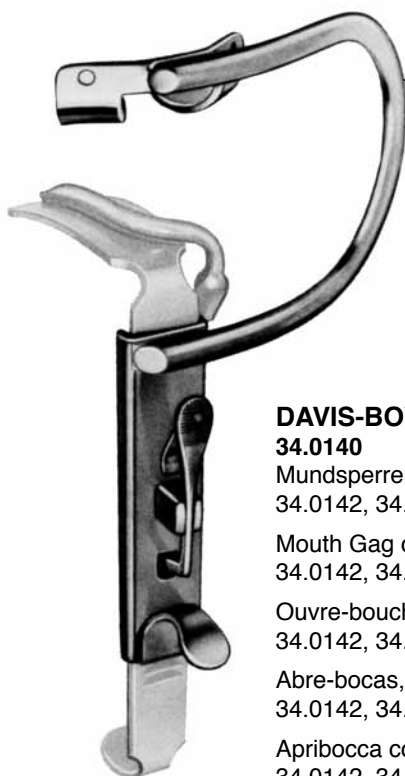

**DAVIS-BOYLE**  
**34.0141**  
Rahmen für Erwachsene /  
Frame for adults / Cadre pour adultes /  
Bastidor para adultos / Telaio per adulti

**34.0148**  
Rahmen für Kinder / Frame for children /  
cadre pour enfants / bastidor para niño /  
telaio per bambini

**DAVIS-BOYLE**

- 34.0140**  
Mundsperrer komplett mit 5 Zungendrückern  
34.0142, 34.0143, 34.0144, 34.0145, 34.0146  
Mouth Gag complete with 5 Tongue Depressors  
34.0142, 34.0143, 34.0144, 34.0145, 34.0146  
Ouvre-bouche, complet avec 5 spatules  
34.0142, 34.0143, 34.0144, 34.0145, 34.0146  
Abre-bocas, complet con 5 spatulas  
34.0142, 34.0143, 34.0144, 34.0145, 34.0146  
Apribocca completo con 5 spatole  
34.0142, 34.0143, 34.0144, 34.0145, 34.0146

alle Rahmen und Zungendrucker sind untereinander austauschbar  
all frames and tongue blades are interchangeable  
Tous les cadres et abaisses-langues sont interchangeables  
Todos los bastidores y bajalenguas son intercambiables  
Tutti i telai ed abbassalingua sono intercambiabili

## DAVIS-MEYER

### 34.0150

Mundsperrer komplett mit 7 Zungendrückern 34.0152, 34.0153, 34.0154, 34.0155, 34.0156, 34.0157, 34.0158

Mouth Gag complete with 7 Tongue Depressors 34.0152, 34.0153, 34.0154, 34.0155, 34.0156, 34.0157, 34.0158

Ouvre-bouche, complet avec 7 spatules 34.0152, 34.0153, 34.0154, 34.0155, 34.0156, 34.0157, 34.0158

Abre-boca, complet con 7 espátulas 34.0152, 34.0153, 34.0154, 34.0155, 34.0156, 34.0157, 34.0158

Apribocca completo con 7 spatole 34.0152, 34.0153, 34.0154, 34.0155, 34.0156, 34.0157, 34.0158



## DAVIS-MEYER

### 34.0151

Rahmen alleine  
Gag only  
Cadre seul  
Cuadro suelto  
Telaio solo

### 34.0152

Fig. 1, 29 x 70 mm

### 34.0153

Fig. 2, 30 x 75 mm

### 34.0154

Fig. 3, 31 x 80 mm

### 34.0155

Fig. 4, 32 x 85 mm

### 34.0156

Fig. 5, 33 x 95 mm

### 34.0157

Fig. 6, 33 x 100 mm

### 34.0158

Fig. 7, 34 x 105 mm

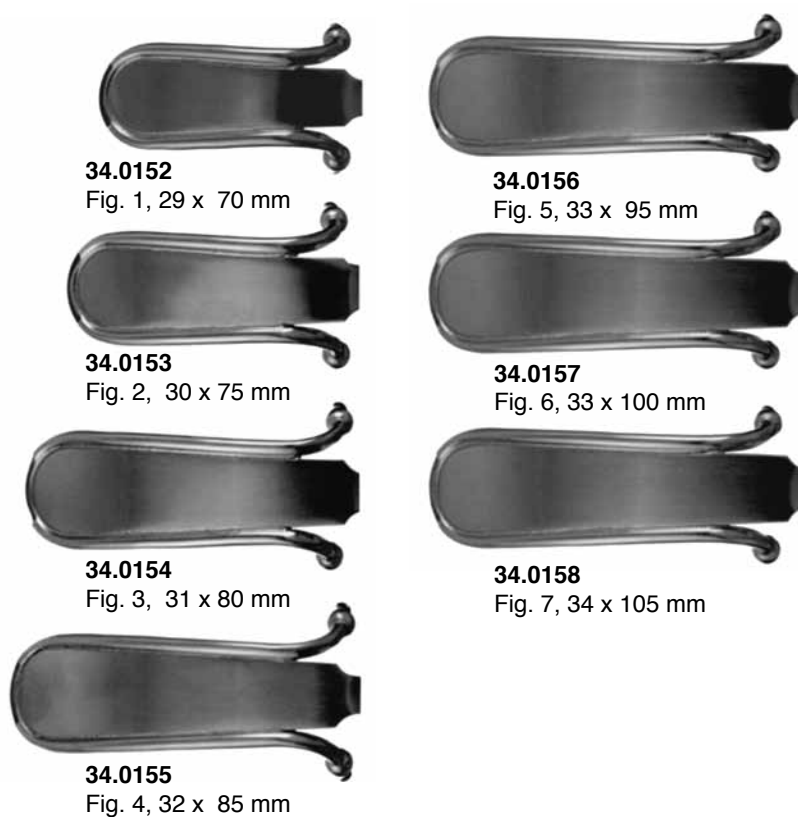

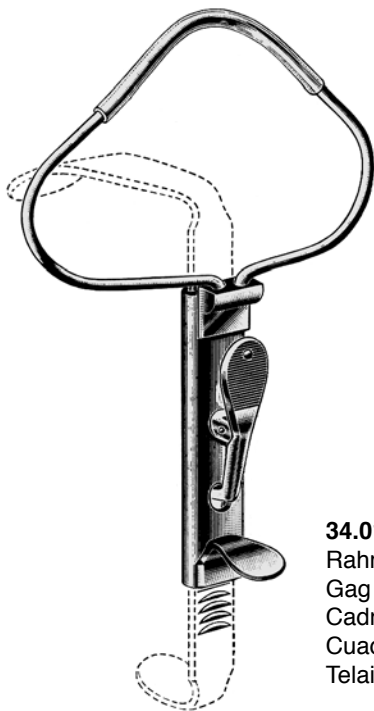

**34.0161**  
Rahmen alleine  
Gag only  
Cadre seul  
Cuadro suelto  
Telaio solo



**34.0162**  
23 x 70 mm



**34.0163**  
25 x 86 mm

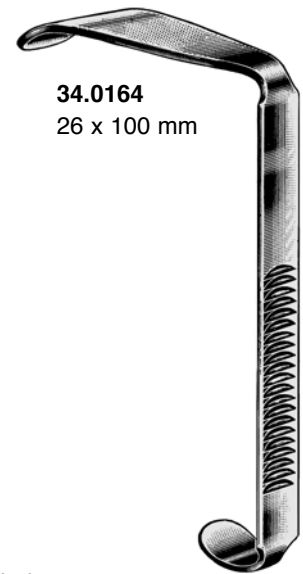

**34.0164**  
26 x 100 mm

**McIVOR**  
**34.0159**

Rahmen für Kinder  
Frame for children  
cadre pour enfants  
bastidor para niños  
telaio per bambini

**MCIVOR**

**34.0160**

Mundsperrer komplett mit 3 Zungendrückern 34.0162, 34.0163, 34.0164  
Mouth Gag complete with 3 Tongue Depressors 34.0162, 34.0163, 34.0164  
Ouvre-bouche, complet avec 3 spatules 34.0162, 34.0163, 34.0164  
Abre-boca, complet con 3 espátulas 34.0162, 34.0163, 34.0164  
Apribocca completo con 3 spatole 34.0162, 34.0163, 34.0164

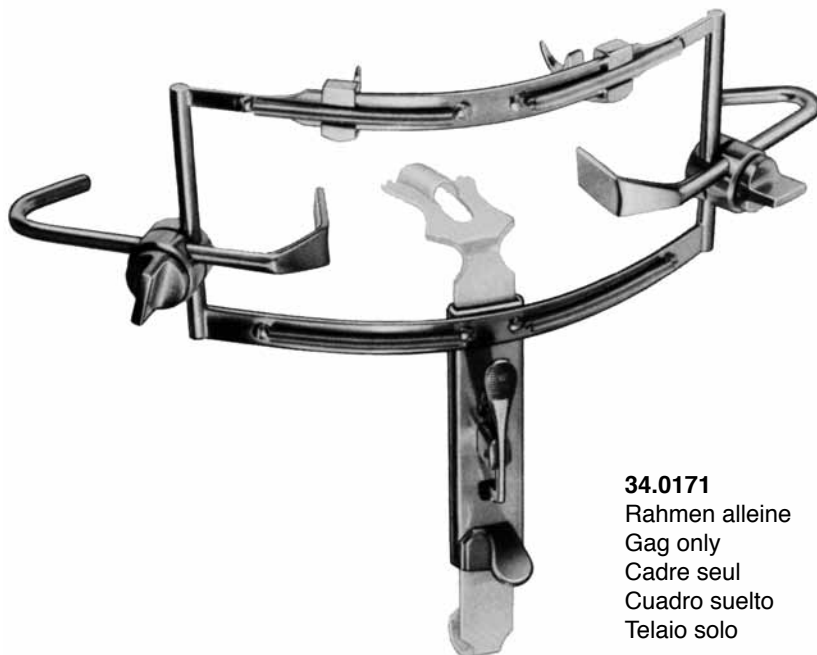

**34.0171**  
Rahmen alleine  
Gag only  
Cadre seul  
Cuadro suelto  
Telaio solo

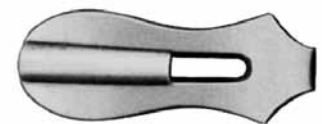

**34.0172 #1**  
24 x 62 mm



**34.0173 #2**  
28 x 65 mm

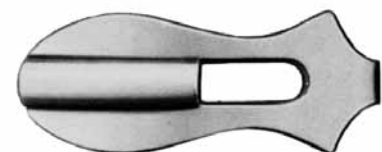

**34.0174 #3**  
31 x 75 mm

**DINGMAN**

**34.0170**

Mundsperrer komplett mit 3 Zungendrückern 34.0172, 34.0173, 34.0174  
Mouth Gag complete with 3 Tongue Depressors 34.0172, 34.0173, 34.0174  
Ouvre-bouche, complet avec 3 spatules 34.0172, 34.0173, 34.0174  
Abre-boca, complet con 3 espátulas 34.0172, 34.0173, 34.0174  
Apribocca completo con 3 spatole 34.0172, 34.0173, 34.0174



**34.0181**  
Rahmen alleine  
Gag only  
Cadre seul  
Cuadro suelto  
Telaio solo



**34.0182 #1**  
28 x 65 mm



**34.0183 #2**  
32 x 75 mm

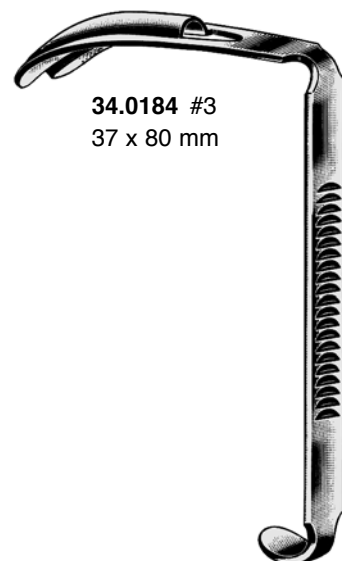

**34.0184 #3**  
37 x 80 mm

## KILNER-DAUGHTY

### 34.0180

Mundsperrer komplett mit 3 Zungendrückern 34.0182, 34.0183, 34.0184  
Mouth Gag complete with 3 Tongue Depressors 34.0182, 34.0183, 34.0184  
Ouvre-bouche, complet avec 3 spatules 34.0182, 34.0183, 34.0184  
Abre-boca, complet con 3 espatulas 34.0182, 34.0183, 34.0184  
Apribocca completo con 3 spatole 34.0182, 34.0183, 34.0184

alle Rahmen und Zungendrucker sind untereinander austauschbar  
all frames and tongue blades are interchangeable  
Tous les cadres et abaisses-langues sont interchangeables  
Todos los bastidores y bajalenguas son intercambiables  
Tutti i telai ed abbassalingua sono intercambiabili



**DAUGHTY (WÜRZBURG)**



**34.0190**  
Fig.1, 28 x 66 mm



**34.0191**  
Fig.2, 32 x 75 mm

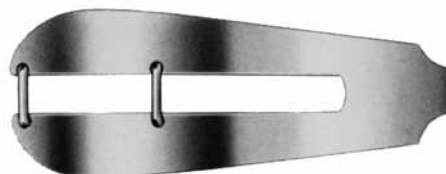

**34.0192**  
Fig.3, 34 x 83 mm

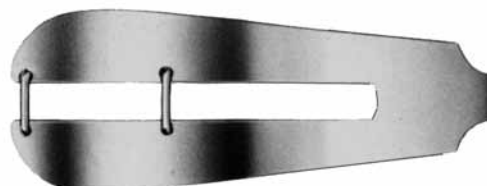

**34.0193**  
Fig.4, 37 x 93 mm

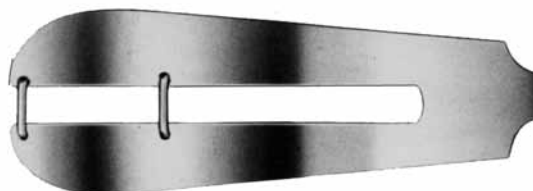

**34.0194**  
Fig.5, 38 x 100 mm



**RUSSEL-DAVIS**



**34.0231 #1**  
29 x 67 mm



**34.0232 #2**  
33 x 75 mm



**34.0233 #3**  
38 x 85 mm



**34.0234 #4**  
40 x 92 mm



**34.0235 #5**  
46 x 100 mm



**34.0236**  
18 x 55 mm



**34.0237**  
22 x 65 mm



**34.0238**  
25 x 75 mm

schmal narrow / étroit /  
estrecho / stretto

alle Rahmen und Zungendrucker sind untereinander austauschbar  
all frames and tongue blades are interchangeable  
Tous les cadres et abaisses-langues sont interchangeables  
Todos los bastidores y bajalenguas son intercambiables  
Tutti i telai ed abbassalingua sono intercambiabili



**34.0251** #2  
23 x 58 mm



**34.0252** #3  
27 x 72 mm



**34.0253** #4  
34 x 87 mm



**34.0254** #5  
37 x 95 mm

links  
left  
gauche  
izquierda  
sinistra



**34.0256**



**34.0257**



**34.0258**



**34.0259**

rechts  
right  
droite  
derecha  
destra



**RING**

Bipod für Mundsperrer  
Bipod for mouth gags  
Bipod pour ouvre-bouche  
Bipodpara abre-boca  
Bipod per apribocca

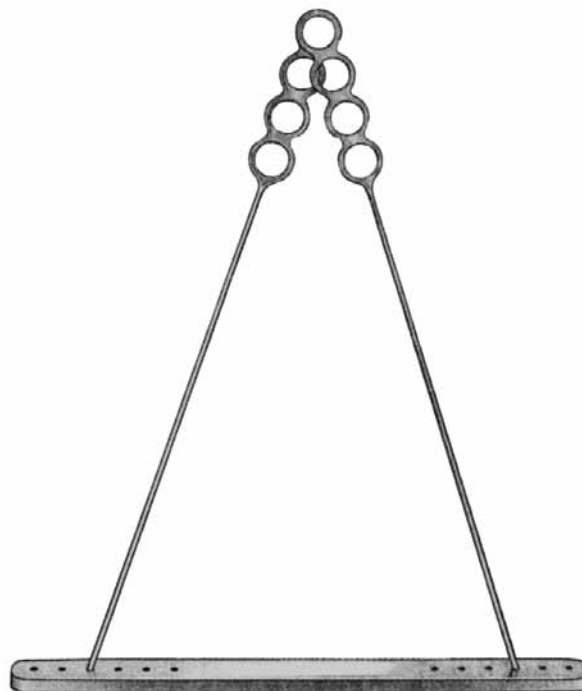

**DRAFFIN**  
34.0290

Bruststütze für Mundsperrer  
Chest Supports for mouth gags  
Supports de poitrine pour ouvre-bouche  
Soporte de pecho para abre bocas  
Sopporti per petto per apribocca



Höhe verstellbar  
height adjustable  
hauteur réglable  
altura ajustable  
altezza regolabile

**NEGUS**  
34.0299

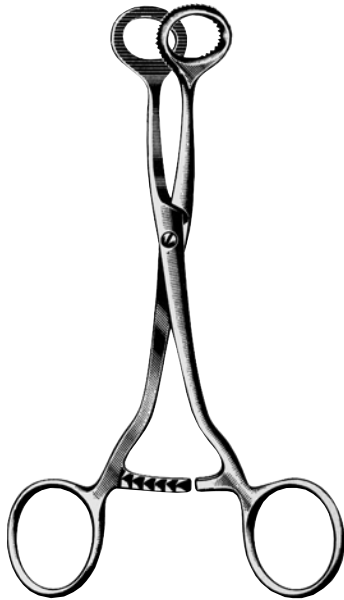

**COLLIN**  
11.0100  
17 cm



**YOUNG**  
11.0119  
Paar  
pair  
paire  
par  
paio

**YOUNG**  
11.0110  
16 cm



**MAGILL**  
11.0300 24 cm  
11.0302 20 cm  
11.0304 17 cm



**SAWTELL (George)**  
**34.0301**  
 19 cm

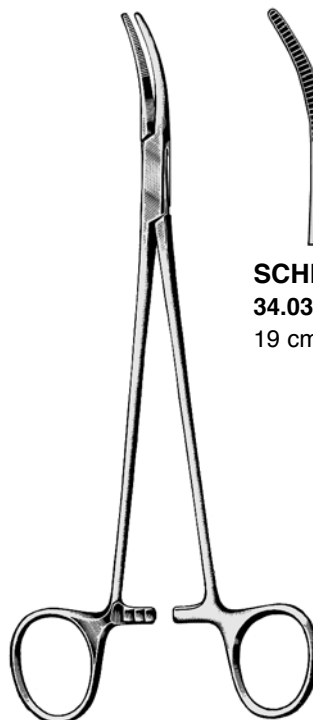

**SCHNIDT**  
**34.0303**  
 19 cm

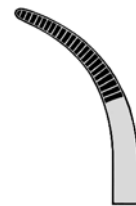

**SAWTELL**  
**34.0305**  
 19 cm

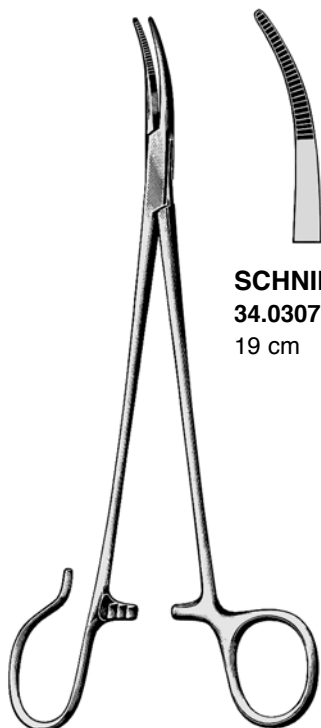

**SCHNIDT**  
**34.0307**  
 19 cm

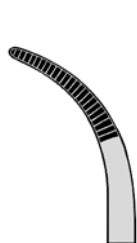

**SAWTELL**  
**34.0309**  
 19 cm



**NEGUS**  
 19 cm



**34.0311**



**34.0313**

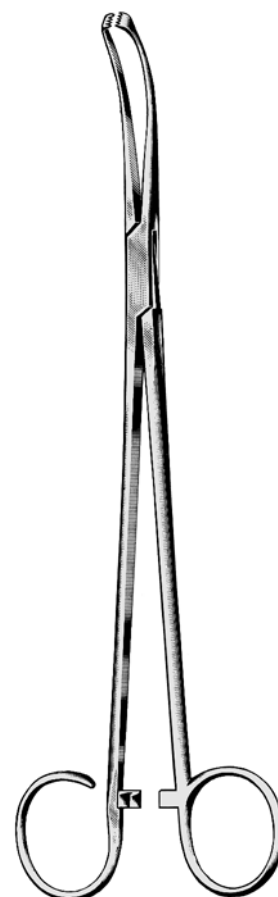

**WHITE**  
**34.0321** 18 cm  
**32.0323** 23 cm



**COLVER**  
19 cm



34.0327



34.0329



**BIRKETT**  
18,5 cm



34.0330



34.0331

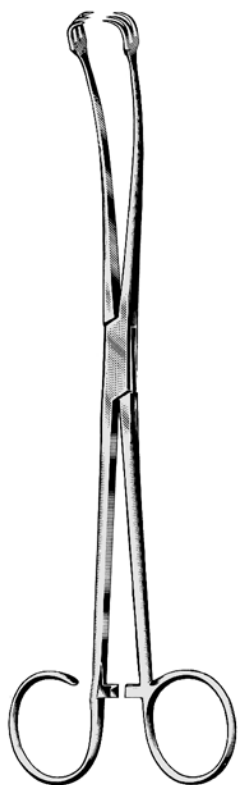

**BALLENGER**  
34.0333  
21,5 cm



**BLOHMKE**  
34.0335  
20 cm



34.0342  
2 x 2

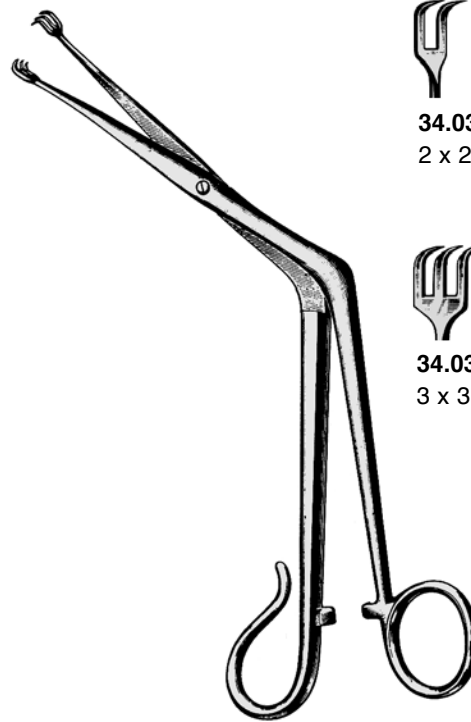

34.0343  
3 x 3

**TIVNEN-TYDING**  
21 cm

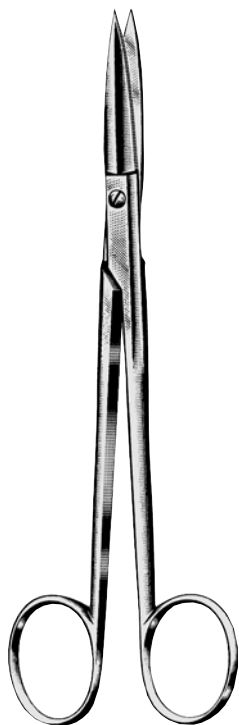

**McINDOE**  
**13.2890**  
 19 cm

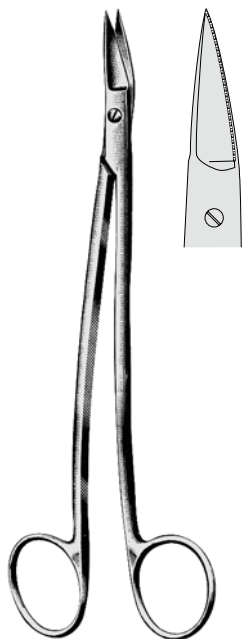

**DEAN**  
**13.2901** 17 cm  
 glatt/smooth  
 lisse/lisa/liscio  
**13.2903** 17 cm,  
 gezahnt/serrated  
 dentée/dentada/  
 dentate



**DEAN**  
**13.5901** 17 cm  
 glatt / smooth / lisse / lisa / liscio  
**13.5903** 17 cm  
 gezahnt / serrated / dentelée  
 dentada / dentate

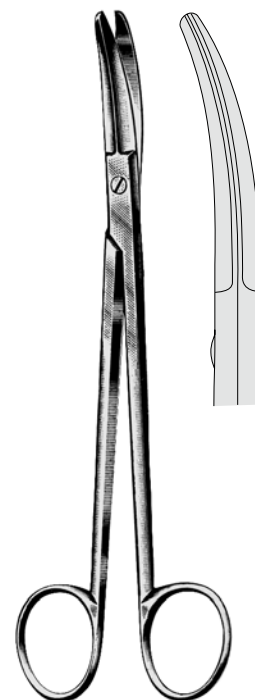

**BOETTCHER**  
**13.2925** 18 cm

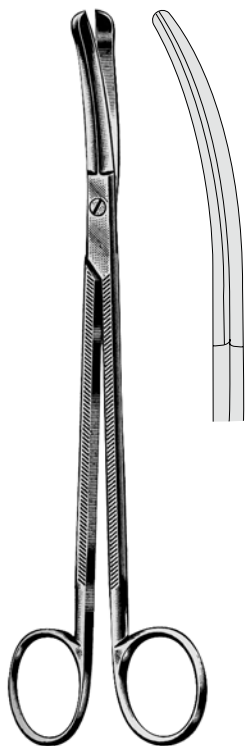

**GOOD**  
**13.2930** 19 cm  
 glatt / smooth / lisse / lisa / liscio  
**13.2932** 19 cm,  
 gezahnt / serrated / dentelée  
 dentada / dentate

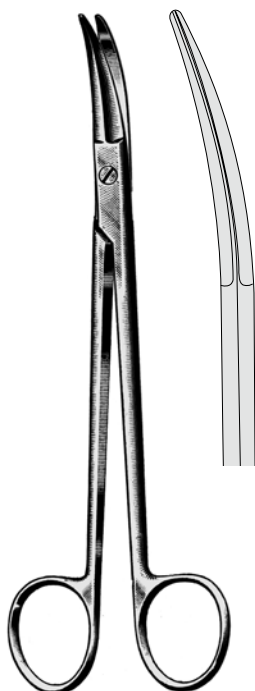

**PRINCE**  
**13.2941** 17 cm

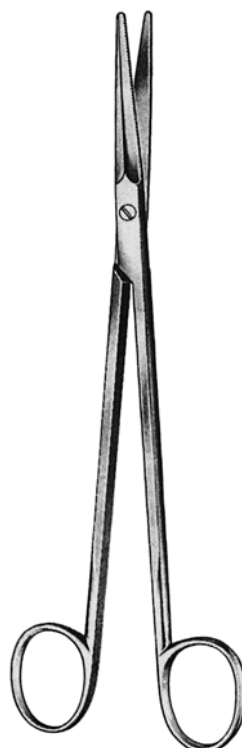

**GORNEY**



**13.3010**  
 12,5 cm



**13.3014**  
 19,0 cm



**13.3015**  
 19,0 cm

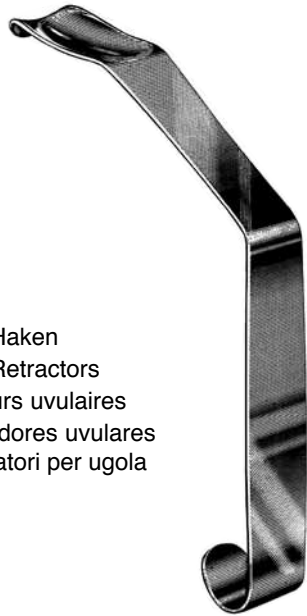

Uvula Haken  
 Uvula Retractors  
 Ecarteurs uvulaires  
 Separadores uvulares  
 Divaricatori per ugola

**LOVE**  
 16 cm  
**34.0370** 18 mm  
**34.0372** 20 mm  
**34.0374** 22 mm



Gaumensegelhalter  
 Soft Palate Retractor  
 Ecarteur pour voile du palais  
 Separador para velo del paladar  
 Divaricatore per velo pendulo

**HASLINGER**  
**34.0380** 16 cm

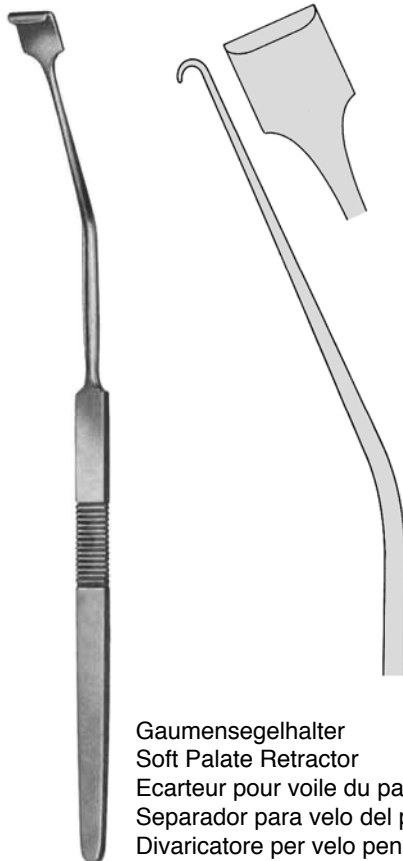

Gaumensegelhalter  
 Soft Palate Retractor  
 Ecarteur pour voile du palais  
 Separador para velo del paladar  
 Divaricatore per velo pendulo

**NAGER**  
**34.0520** 23 cm



Gaumenbogenhaken  
 Palate Arch Retractor  
 Ecarteur pour voûte palatine  
 Separador para arco del paladar  
 Divaricatore per velo pendulo

**HOFER**  
**34.0530** 24 cm

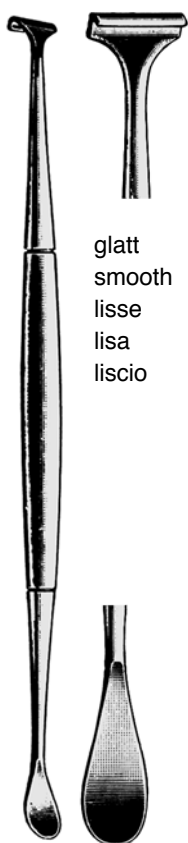

glatt  
 smooth  
 lisse  
 lisa  
 liscio

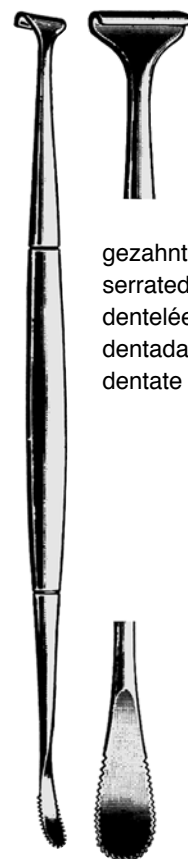

gezahnt  
 serrated  
 dentelée  
 dentada  
 dentate

**HURD**  
 34.0500 22,5 cm

**HURD**  
 34.0502 22,5 cm

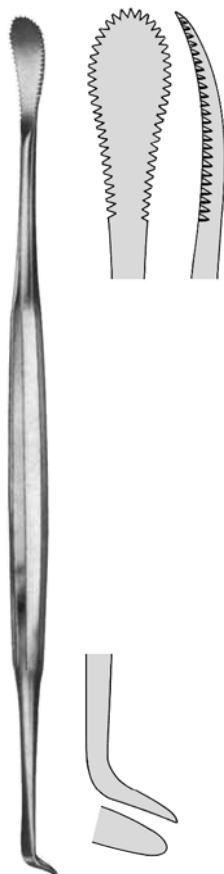

**HENKE**  
 34.0510 23 cm



**HENKE**  
 34.0512 23 cm

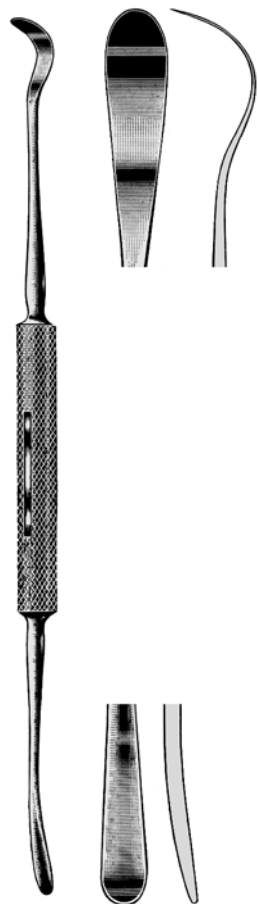

**CARPENTER**  
 34.0516  
 24 cm

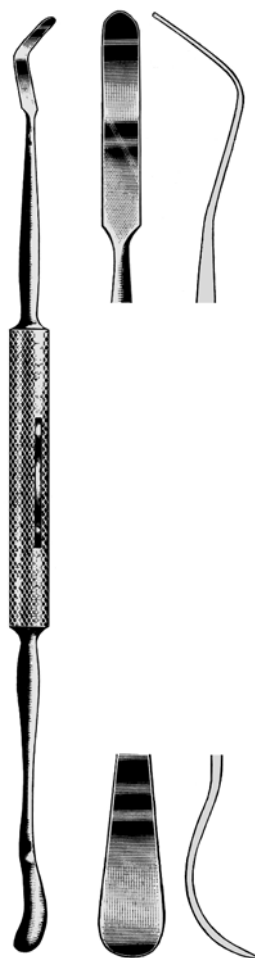

**CARPENTER**  
 34.0517  
 25 cm



mit Absaugvorrichtung  
 with suction device  
 avec aspiration  
 con aspiración  
 con aspiratore

**LOPEZ-REINKE**  
 34.0504  
 23,5 cm

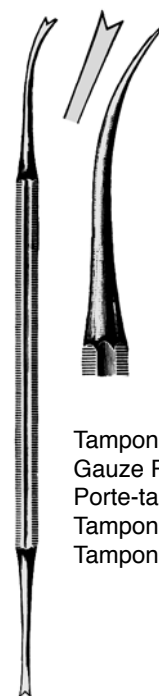

Tamponstopfer  
 Gauze Packer  
 Porte-tampon  
 Tamponeador  
 Tamponatore

**LUNIATSCHEK**  
 34.0540  
 19 cm



**CLAUS-EICKEN**  
**34.0662**  
 23 cm



**NAGER**  
**34.0664**  
 24 cm

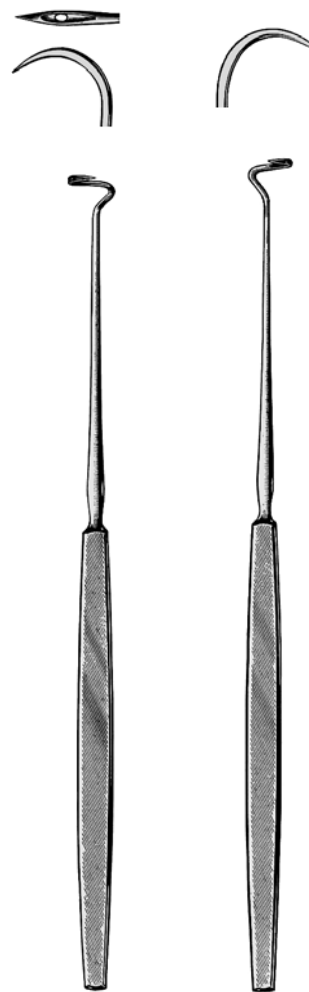

**DUPUY-WEISS**  
 22 cm  
**34.0670** für die rechte Hand  
 for right hand  
 pour main droite para  
 la mano derecha  
 per la mano destra  
**34.0671** für die linke Hand  
 for left hand  
 pour main gauche  
 para la mano izquierda  
 per la mano sinistra

**PRO-MED** ist Ihnen behilflich bei der Zusammenstellung von Operationsbestecken für die verschiedensten Disziplinen. Fragen Sie nach unseren vorbereiteten OP-Bestecken.

For your convenience a wide variety of Suggested Operating Sets for most general and specialized procedures is available from **PRO-MED**. Please contact us or your local dealer.

**PRO-MED** vous propose de multiples compositions de boîtes opératoires multidisciplinaires. Demandez nos suggestions pour de nombreuses interventions.

**PRO-MED** le ayuda en componer varias cajas de instrumentos quirúrgicos. Pregunte por nuestro instrumental quirúrgico preparado.

Per la vostra comodità **PRO-MED** Vi aiuta nella raccolta di strumenti chirurgici per le varie discipline. Vi preghiamo di chiedere informazioni sui nostri set di strumenti chirurgici già preparati.



**HURD**  
21 cm

**34.0672**

für die rechte Hand  
for right hand  
pour main droite para  
la mano derecha  
per la mano destra

**34.0673**

für die linke Hand  
for left hand  
pour main gauche  
para la mano izquierda  
per la mano sinistra

**FALK**  
24 cm

**34.0674**

für die rechte Hand  
for right hand  
pour main droite para  
la mano derecha  
per la mano destra

**34.0675**

für die linke Hand  
for left hand  
pour main gauche  
para la mano izquierda  
per la mano sinistra



**ABRAHAM**  
 34.0800 21 cm



**FOWLER**  
 34.0806 20 cm

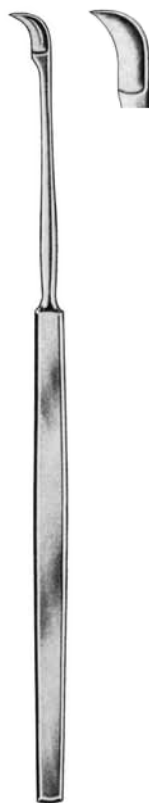

**CANFIELD**  
 34.0810 21 cm



**DOUGLAS**  
 34.0820 21 cm



**TYDING**  
 34.0825 21 cm



**FISHER**  
 34.0830 22 cm



**BRUENINGS**  
 34.0850 23 cm



**DEAN**  
 34.0860 19 cm

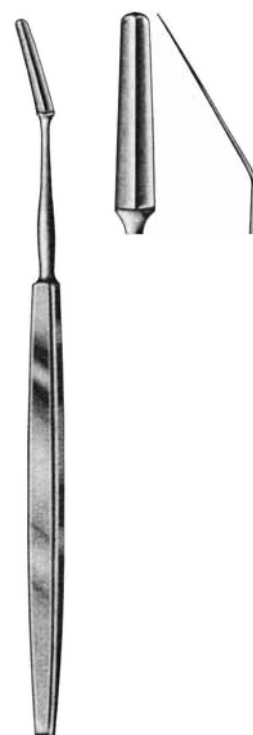

**DEAN**  
 34.0861 19 cm

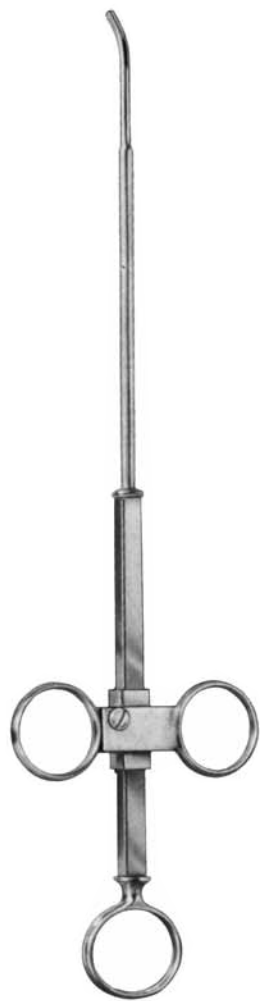

**ROEDER**  
 34.0660  
 26,5 cm



**EVES**  
 34.1000  
 28 cm



**EVES**  
 34.1005  
 28 cm

mit Sperre  
 with catch  
 avec crémaillère  
 con cremallera  
 con cremagliera

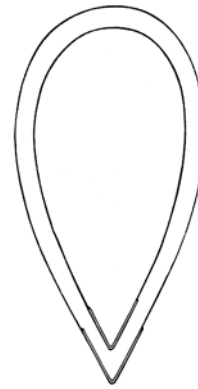

100 Stück  
 100 pieces  
 100 pieces  
 100 piezas  
 100 pezzi  
 34.1007 40 mm  
 34.1008 50 mm

12 Stück  
 12 pieces  
 12 pieces  
 12 piezas  
 12 pezzi



34.1009 0,3 mm Ø



mit Sperre  
 with catch  
 avec crémaillère  
 con cremallera  
 con cremagliera

**BRUENINGS**  
 34.1010  
 28 cm

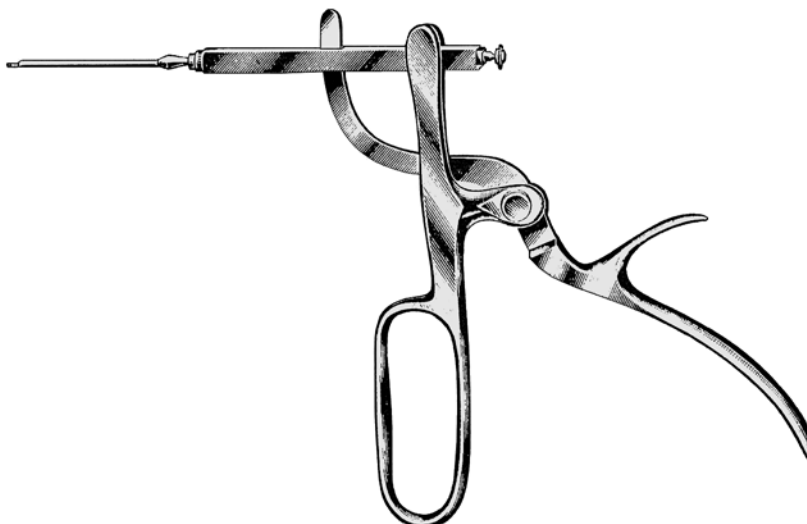

**TYDING**  
 34.1050  
 mit geradem Aufsatz  
 with straight tip  
 avec embout droit  
 con guida-asa recto  
 con terminale retto

Aufsätze allein  
Blades only  
Embouts seuls  
Puntas sueltas  
Lame sole



### SLUDER-BALLEGER

**34.1113**

komplett mit 3 Aufsätzen 34.1115, 34.1116, 34.1117  
complete with 3 tips 34.1115, 34.1116, 34.1117  
complet avec 3 embouts 34.1115, 34.1116, 34.1117  
completo con 3 puntas 34.1115, 34.1116, 34.1117  
completo con 3 lame 34.1115, 34.1116, 34.1117

34.1114  
Griff allein  
Handle only  
Manche seul  
Mango suelto  
Manico solo

Messer alleine  
Knives only  
Couteaus seul  
Cuchillos solo  
Coltelli solo 16 mm

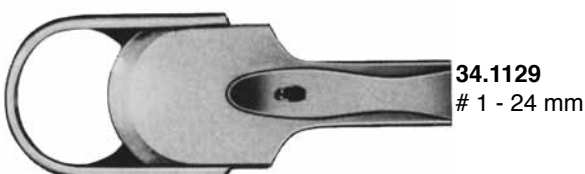
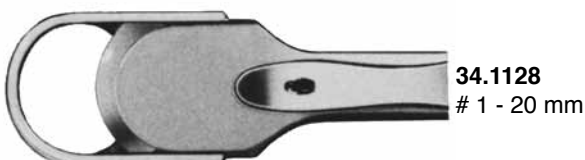

Tonsillotome mit Doppelklinge zum Quetschen und Schneiden  
Tonsillotomes with double blade for squeezing and cutting  
Amygdalotomes avec lame double pour écraser et couper  
Amigdalotómos con hoja doble para magullar y cortar  
Tonsillotomi con lama doppio per schiacciare e tagliare



### DANIELS

**34.1121** 16 mm

**34.1122** 20 mm

**34.1123** 24 mm